

# **STORM WATER MANAGEMENT REPORT**

**Lots D & G – Crown Simsbury  
Dorset Crossing PAD  
115 & 130 Casterbridge Crossing  
Simsbury, CT**

Prepared For:

**Crown Property Holdings, LLC**

Prepared By:

**F. A. Hesketh & Associates, Inc.  
3 Creamery Brook  
East Granby, CT 06026**



**FAHA #04174.30**

**December 3, 2021  
Revised December 17, 2021**

## **1. Introduction**

This storm water management report has been prepared to demonstrate that the storm water management practices for the proposed development meet the design goals and requirements of the Town of Simsbury Stormwater and Zoning Regulations and the previously approved Master Drainage Study for Dorset Crossing PAD, attain the goal of the CT DEEP 2004 Stormwater Quality Manual (SWQM) and follow sound engineering practices while protecting adjacent landowners and downstream wetland resources from adverse storm water impacts.

This report presents an updated summary of macro hydrologic and hydraulic (pipe to pipe) analysis for the Dorset Crossing Development PAD on Hopmeadow Street-Route 10, in particular the development of Lots D & G and the extension of Casterbridge Crossing. To date, there have been a number of plan revisions for Dorset Crossing PAD submitted and approved by the town's land use commissions and town staff. Each request for approval/revision included submittal of an updated hydrologic and hydraulic analysis for the proposed stormwater management systems. During the Master Plan PAD approval process dating back to 2012, a Master Drainage Study was completed.

In accordance with this Master Drainage Study, basically all development including the new town roads and site development north of Saxton Brook drain to the detention basin constructed on Lot B, which is now the site for The Pointe Apartments. Only a limited portion of Lot A and the first 500 +/- feet of Dorset Crossing, a town road, drain to an underground chamber storage system and then to the Route 10-Hopmeadow Street CTDOT drainage system. All discharge is tributary to Saxton Brook. The two lots south of Saxton Brook, Lots D & G, would construct individual stormwater systems with discharge to Saxton Brook to handle site discharges to meet the design goals.

This report also presents a detailed pipe-to-pipe design analysis to demonstrate that the proposed site storm drain system has adequate capacity to convey runoff for a 25-year return-period storm event.

## **2. Project Description**

The project site includes two existing building lots at the end of Casterbridge Crossing, Lot 13 A-D (#130) 2.48 acres and Lot 13 A-G (#115) 4.54 acres (AKA Lots D & G). These lots are part of the Master Plan approved for the Dorset Crossing PAD. Between these two lots is the approved right-of-way for Casterbridge Crossing, a town road. Casterbridge Crossing ends at a temporary cul-de-sac at the entrance to this project. A ROW is reserved for a possible future extension of the road to serve the land to the south. Most of the developable area on the two lots has been heavily disturbed by previous sand and gravel excavation operations, trenching and grading related to the installation of a town sanitary

sewer main in the 1970's and more recent construction staging areas and material stockpiles.

A new storm drain collection system is proposed to handle runoff from the building rooftops and the paved portions of the development. The system will consist of a combination of catch basins with 2 ft. sumps, manholes, **trap hoods** for pavement area catch basins, underground storage/infiltrator units, one excavated water quality basin on Lot G and two new flared-end outlets. Stormwater from paved parking area and drives will be discharged into a system designed to capture and treat the minimum CT DEEP recommended water quality volume (WQV). Since mixing of roof water and pavement runoff occurs, the overall system has been designed to provide water quality volume for all runoff generated on both lots.

### **3. Hydrologic Analysis**

The design of the stormwater management system for the proposed development is aimed at mitigating total peak rate of runoff and promoting stormwater water quality through use of underground storage/infiltrator units and the water quality basin. The design goal is to meet the requirements of the Simsbury Stormwater regulations including the incorporation of Low Impact Design (LID) strategies and Best Management Practices (BMP). Taking advantage of the underlying sand and gravel soils and implementing onsite detention and infiltration along with reducing paved surfaces through the use of inside garage parking is an overall design scheme that meets both the LID and BMP goals.

A hydrologic analysis was conducted for both the existing condition and the proposed developed condition of the site to determine peak flow of runoff and total volume of runoff, under both conditions. Hydraflow Hydrographs 2007 computer software was utilized in the analysis.

Due to the small size of the watershed areas, the Rational Method was used to determine peak flows and total volume of runoff for both the pre- and post-redeveloped conditions. Specific times of concentration were determined for all watersheds being analyzed.

In accordance with CT DOT protocol, rainfall intensity data for the project area is taken from NOAA Atlas 14 data off the NOAA website. A copy of the NOAA rainfall data and the Rainfall Intensity Curve is presented in Attachment A.

Surficial Soil mapping indicates that existing soil types are primarily 305-Udorthens/pit complex within the development area and Aquent soil (Wetland Soil) on portions of the vegetated slopes leading down to Saxton Brook. From the geologic/geotechnic perspective, the natural soils at the site are from shallow lake deposits atop moraine. These deposits consist generally of fine to coarse sand with trace to little silt. The underlying moraine deposits consist of well graded compact to very compact fine to medium sand with some silt and gravel. These soil types have been verified by geotechnical borings completed for other recent

developments in the PAD. Based on results from previous borings and excavations completed, it is expected that existing groundwater elevation will be 5-7 feet below existing grade.

Rational Method Runoff Coefficients used for the various land-use types are based on the following values:

- C=0.90 for impervious areas (i.e., rooftops, paved areas, sidewalks, etc.).
- C=0.15 for all landscaped areas; and
- C=0.30 for all wooded areas

#### Existing Conditions Analysis:

The project area including both Lots D & G was divided into two watersheds following existing topographic divides as depicted on Sheet DA-1. Both watersheds drain overland to Saxton Brook. EX WEST, the West watershed, which is essentially Lot D, is comprised of 2.63 ac. of a mixture of vegetated slopes and a relatively level open disturbed area. This watershed drains to Design Point 1. EX-EAST, the East watershed, which is essentially Lot G, is comprised of 5.11 acres of a mixture of vegetated slopes and a relatively level open disturbed-area. This watershed drains to Design Point 2.

Travel times for the existing conditions watershed were calculated using the TR-55 Rational Method provided in the Hydraflow program. The Hydraflow model calculates the total volume and peak rate of discharge for the existing conditions watersheds. Results are summarized in Attachment A.

#### Proposed Conditions Analysis:

The post-developed contribution areas are modeled substantially the same as those of the existing site conditions. All runoff from the site will continue to flow in a similar fashion as existing conditions. Developed portions of the watershed, however, will be captured and detained/infiltrated by the proposed underground storage system and one new water quality basin on Lot G.

Remaining un-detained areas will continue to flow generally as they do under the existing site conditions. The model analyzes the peak flow to each of the un-detained watersheds and the detained flow to the underground systems and the water quality basin to provide the post-developed condition total flows.

For the proposed-condition watersheds, the times of concentration were also calculated using the TR-55 Rational Method provided in the Hydraflow program. The stage-storage relationships for the underground storage systems and the water quality basin are calculated by the model using the conical method by inputting the elevation and area of contours within the basin. Contour areas are determined by polyline delineations in the AutoCAD drawings.

The stage-discharge relationship for the underground storage systems and the basin outlet is modeled by the program, following input of the outlet geometry. For the water quality basin, the overflow outlet structure will consist of precast concrete structure. Stage-Storage and Stage-Discharge relationships for the water quality basin are presented in the model input/output, which is included as Attachment A.

The water quality basin is designed to act as essentially a dry detention/infiltration basin. The underlying soils will allow for infiltration. The basin is sized to capture and detain 100 percent of the volume of all modeled storm events from the 2 through 100-year event. It is assumed that between storm events, the accumulated stormwater would partially infiltrate into the underlying soils and the basin would be empty at the start of the next storm event. The results of the hydrologic modeling for existing versus proposed conditions at the two design points is presented below in Table 1.

**TABLE 1**  
**Peak Rates of Runoff**  
**Existing vs. Proposed Conditions**

**At Design Point 1**  
**(West Watershed)**

Return Period (years)	Peak Rate of Flow (CFS)	
	Existing	Proposed
2-Yr	3.4	3.4
5-Yr	4.3	4.2
10-Yr	5.1	4.9
25-Yr	6.1	5.8
50-Yr	6.9	6.5
100-Yr	7.8	7.2

**At Design Point 2**  
**(East Watershed)**

Return Period (years)	Peak Rate of Flow (CFS)	
	Existing	Proposed
2-Yr	7.1	3.7
5-Yr	9.0	5.0
10-Yr	11	5.9
25-Yr	13	7.1
50-Yr	14	8.1
100-Yr	16	9.0

Town Regulations require the detention facilities to be designed to handle storm frequencies from the 2 to 100-year frequency. The results show that the proposed design meets the design goal reducing proposed peak flows below existing conditions. The combination of underground storage/infiltrator units and the water quality basin proposed will handle up to and including the 100-year event with a total of one foot of freeboard in the water quality basin on Lot G.

#### 4. Water Quality Volume Computations

In accordance with Chapter 7 of the 2004 CTDEEP Stormwater Quality Manual, the water quality basin has been designed to capture and treat the minimum Water Quality Volume (WQV) from the paved surfaces. WQV runoff from the building roof drains is directed to underground infiltrator systems.

A combination of underground storage units and one water quality basin are proposed to provide the WQV for the project. This combination of systems is designed to capture and treat more than the minimum required WQV recommended by the 2004 Connecticut Stormwater Quality Manual (see Section 7.4.1 of the Manual). WQV calculations for the Water Quality Basin is provided below, using the CTDEEP formula:

*Water Quality Volume:*

Water Quality Volume recommended:  $WQV = [(1'')(R)(A)] / 12$

WQV = Water Quality Volume  
R = Vol. runoff coefficient =  $0.05 + 0.009 * (I)$   
I = percent impervious cover  
A = site area in acres

Calculations for determining the minimum-recommended WQV and demonstrating that more than the minimum-recommended WQV is provided are included in Attachment A.

#### 5. Pipe to Pipe Design Analysis

The proposed development on Lots D & G will employ storm drain systems, which are depicted on Sheets GR-1 and UT-1 the submittal set. The storm drains proposed to convey the runoff have been designed to handle the peak flow for a 25-year storm event. To design and analyze the system, a detailed, pipe to pipe analysis was conducted using Hydraflow Storm Sewers Extension (2008) for Windows software. This software uses the Rational Method and Manning's Formula to compute peak flow to each basin, and to calculate the capacity of individual pipes.

Input data includes the geometry and configuration of the storm drain system, catchment area of the inlet, weighted runoff coefficients, and time to inlet. The catchment areas are calculated based on proposed topography utilizing polyline delineations in AutoCAD. The catchment areas are depicted graphically on Map DA-3.

A weighted runoff coefficient is calculated based on percentages of landscaped

and impervious areas within the catchment area. In this case, most of the contributing areas are impervious.

Times to inlet were all assumed to be five minutes for catchment areas that are primarily paved. A Manning roughness coefficient of 0.012 was used for the HDPE culvert pipe analyzed and a Manning roughness coefficient of 0.013 was used for the RCP culvert analyzed. Rainfall intensity data was taken from NOAA Atlas 14 rates off the NOAA website for the project area. A copy of the Rainfall Intensity Curve is presented in Attachment A.

The model calculates the capacity of the pipe and accounts for loss coefficients at inlet and outlet controls, whichever governs. Input data includes basin geometry, longitudinal slope, cross slope, and basin depression. State of CT DOT 'Type-C' basins or 'Type C-L' drains were modeled for the basin, as appropriate.

The system serving Lot D will be connected to the town drainage system in Casterbridge Crossing in accordance with the plans previously approved for the roadway extension. Flow generated from Lot G is passed thru a proposed water quality basin with outflow to a new 15" culvert outlet to the brook corridor. Results of analysis are attached and include summaries of system design based on CT DOT output formats. Program input and output data reports are presented in Attachment A.

## **6. Summary**

The analysis indicates that the proposed stormwater management system meets the design goals of incorporating Water Quality, LID and BMP practices outlined in the town stormwater regulations and CTDEEP requirements and ensures that there will be no negative impact to abutting properties for all storm events up to and including the 100-year storm.

# ATTACHMENT A

## HYDROLOGIC ANALYSIS

Crown Simsbury Apartments at Dorset Crossing  
Lots D & G – Dorset Crossing Pad

December 17, 2021



# Drainage Area Maps



103' SHEET FLOW  
n=0.4 S=31.35%

67' SHEET FLOW  
n=0.4 S=46.08%

Tc FLOW PATH  
(TYP.)

**WATERSHED AREAS**  
337,132 s.f. (7.74 Ac.)

IMPERVIOUS (C=0.90)	WOODS (C=0.30)
EXISTING EAST 222,453 s.f. (5.11 AC.)	
11,348 S.F. (0.26 Ac.)	211,105 S.F. (4.85Ac.)
EXISTING WEST 114,677 s.f. (2.63 Ac.)	
7,005 S.F. (0.16 Ac.)	107,674 s.f. (2.47 Ac.)

**Crown Simsbury**

**F. A. Hesketh & Associates, Inc.**  
3 Creamery Brook, East Granby, CT 06026  
Phone (860) 653-8000 Fax (860) 844-8600  
www.fah.com · Planners · Landscape Architects



No.	Date	Revisions: Description

**CROWN PROPERTY HOLDINGS, LLC**  
DRAINAGE ANALYSIS PLAN  
EXISTING CONDITIONS  
PREPARED FOR  
CASTERBRIDGE CROSSING  
SIMSBURY, CONNECTICUT  
Date: 12-03-2021 Drawn by: DR7 Job no: 04174  
Scale: 1" = 40' Checked by: DSZ Sheet no: 1 OF 1

**DA-1**

G:\2024\04174\30 - Lots G and D\Resub\Submit\2021-12-15.dwg, DA-1, Dec. 16, 2021 - 1:48:28 PM

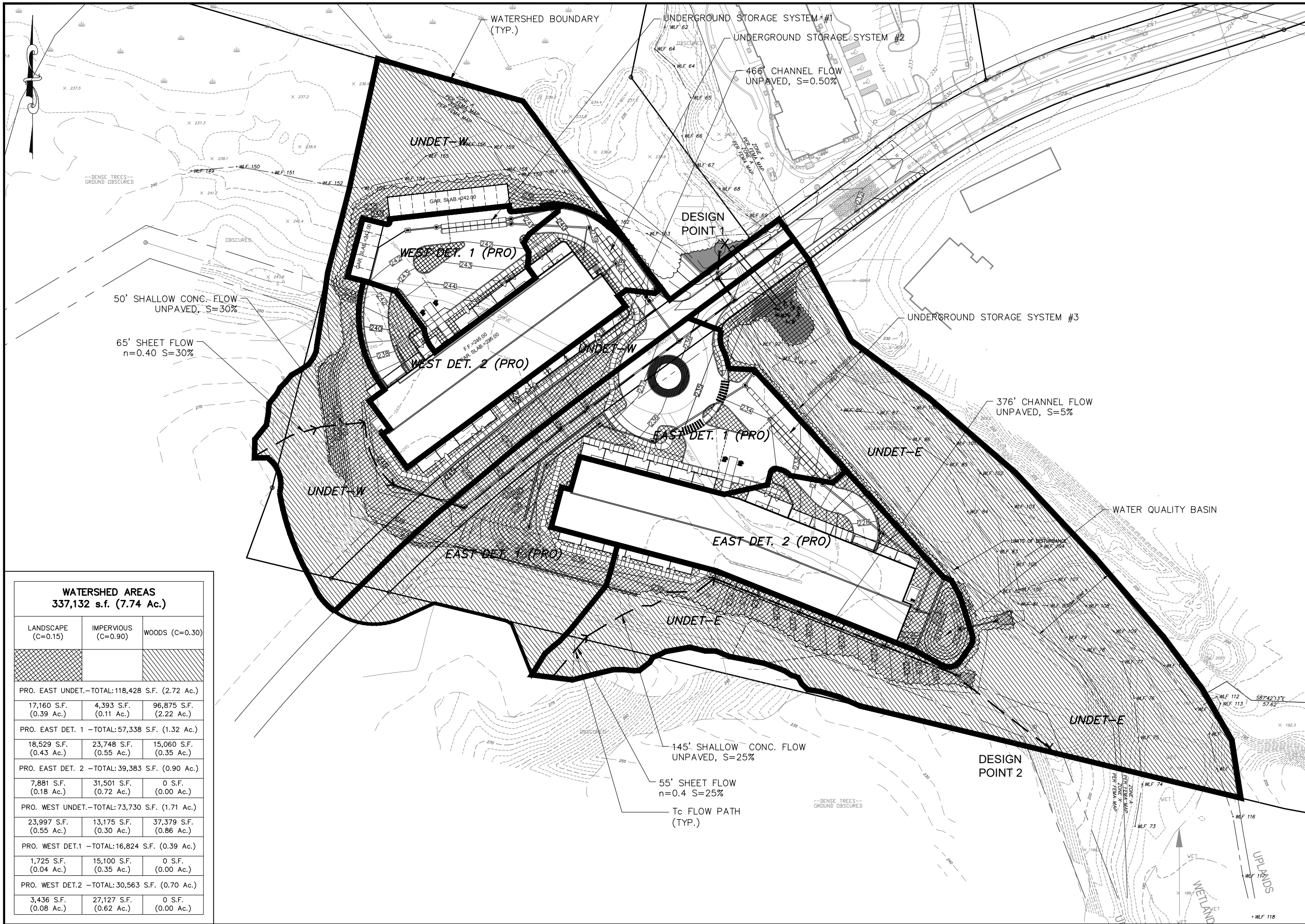

**WATERSHED AREAS  
337,132 s.f. (7.74 Ac.)**

LANDSCAPE (C=0.15)	IMPERVIOUS (C=0.90)	WOODS (C=0.30)
PRO. EAST UNDET.—TOTAL: 118,428 S.F. (2.72 Ac.)		
17,160 S.F. (0.39 Ac.)	4,393 S.F. (0.11 Ac.)	96,875 S.F. (2.22 Ac.)
PRO. EAST DET. 1 —TOTAL: 57,338 S.F. (1.32 Ac.)		
18,529 S.F. (0.43 Ac.)	23,748 S.F. (0.55 Ac.)	15,060 S.F. (0.35 Ac.)
PRO. EAST DET. 2 —TOTAL: 39,383 S.F. (0.90 Ac.)		
7,881 S.F. (0.18 Ac.)	31,501 S.F. (0.72 Ac.)	0 S.F. (0.00 Ac.)
PRO. WEST UNDET.—TOTAL: 73,730 S.F. (1.71 Ac.)		
23,997 S.F. (0.55 Ac.)	13,175 S.F. (0.30 Ac.)	37,379 S.F. (0.86 Ac.)
PRO. WEST DET.1 —TOTAL: 16,824 S.F. (0.39 Ac.)		
1,725 S.F. (0.04 Ac.)	15,100 S.F. (0.35 Ac.)	0 S.F. (0.00 Ac.)
PRO. WEST DET.2 —TOTAL: 30,563 S.F. (0.70 Ac.)		
3,436 S.F. (0.08 Ac.)	27,127 S.F. (0.62 Ac.)	0 S.F. (0.00 Ac.)

**Crown Simsbury**

F. A. Hesketh & Associates, Inc.

3 Creamery Brook, East Granby, CT 06026  
Phone: (860) 659-8000 Fax: (860) 844-8600  
www.fah.com • Landscapes Architects



Revisions:	
No.	Date
1.	12-17-2021
	Description
	1. Planning & Zoning Submission

**DA-2**

G:\2024\04174-30 - Lots 6 and D\Vegetary\Submitted\2021-12-15 Planning and Zoning\1AP\DA-1 2021-12-15.dwg, DA-2, Dec. 17, 2021 - 8:49:46 AM

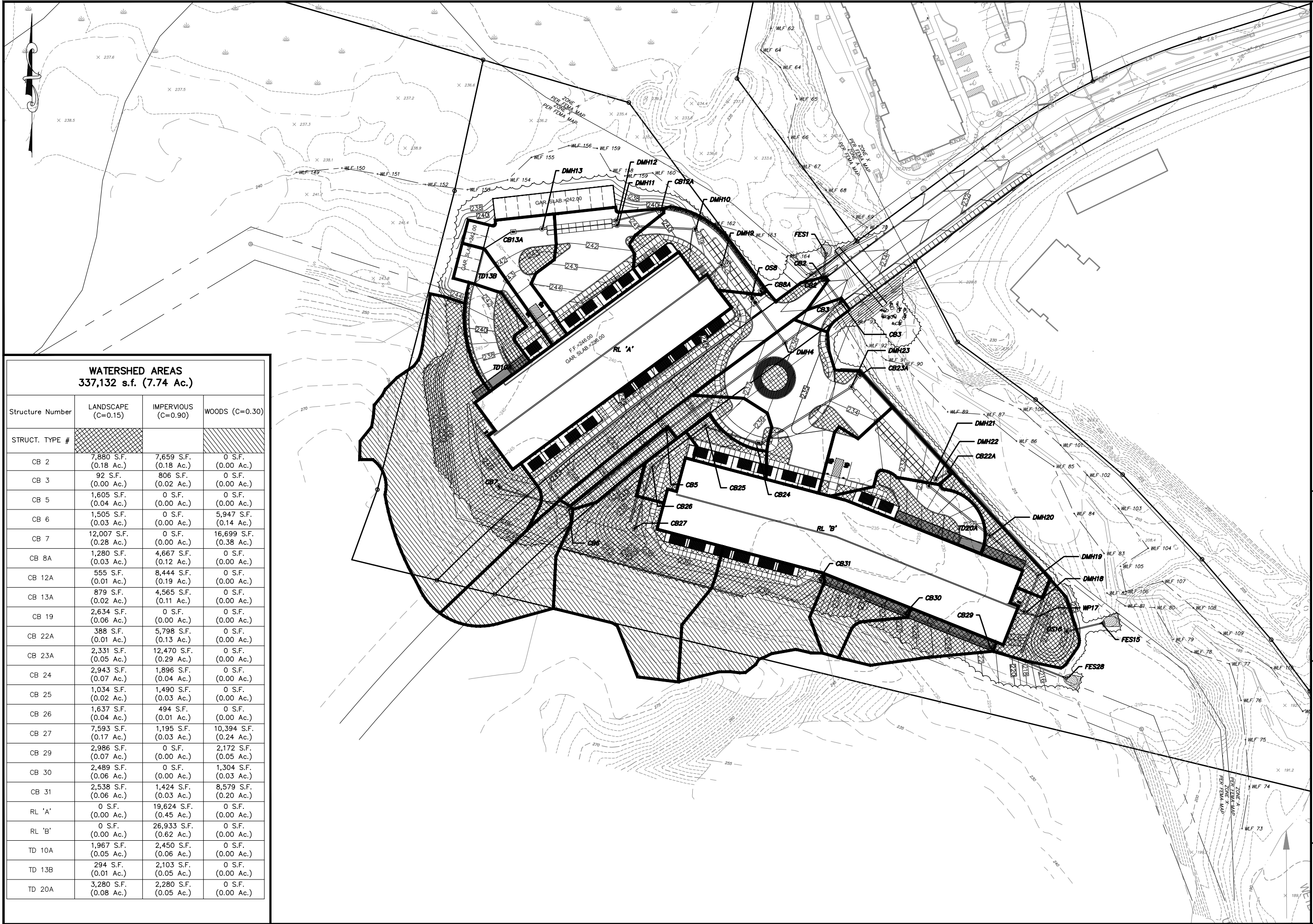

**WATERSHED AREAS**  
337,132 s.f. (7.74 Ac.)

Structure Number	LANDSCAPE (C=0.15)	IMPERVIOUS (C=0.90)	WOODS (C=0.30)
CB 2	7,880 S.F. (0.18 Ac.)	7,659 S.F. (0.18 Ac.)	0 S.F. (0.00 Ac.)
CB 3	92 S.F. (0.00 Ac.)	806 S.F. (0.02 Ac.)	0 S.F. (0.00 Ac.)
CB 5	1,605 S.F. (0.04 Ac.)	0 S.F. (0.00 Ac.)	0 S.F. (0.00 Ac.)
CB 6	1,505 S.F. (0.03 Ac.)	0 S.F. (0.00 Ac.)	5,947 S.F. (0.14 Ac.)
CB 7	12,007 S.F. (0.28 Ac.)	0 S.F. (0.00 Ac.)	16,699 S.F. (0.38 Ac.)
CB 8A	1,280 S.F. (0.03 Ac.)	4,667 S.F. (0.12 Ac.)	0 S.F. (0.00 Ac.)
CB 12A	555 S.F. (0.01 Ac.)	8,444 S.F. (0.19 Ac.)	0 S.F. (0.00 Ac.)
CB 13A	879 S.F. (0.02 Ac.)	4,565 S.F. (0.11 Ac.)	0 S.F. (0.00 Ac.)
CB 19	2,634 S.F. (0.06 Ac.)	0 S.F. (0.00 Ac.)	0 S.F. (0.00 Ac.)
CB 22A	388 S.F. (0.01 Ac.)	5,798 S.F. (0.13 Ac.)	0 S.F. (0.00 Ac.)
CB 23A	2,331 S.F. (0.05 Ac.)	12,470 S.F. (0.29 Ac.)	0 S.F. (0.00 Ac.)
CB 24	2,943 S.F. (0.07 Ac.)	1,896 S.F. (0.04 Ac.)	0 S.F. (0.00 Ac.)
CB 25	1,034 S.F. (0.02 Ac.)	1,490 S.F. (0.03 Ac.)	0 S.F. (0.00 Ac.)
CB 26	1,637 S.F. (0.04 Ac.)	494 S.F. (0.01 Ac.)	0 S.F. (0.00 Ac.)
CB 27	7,593 S.F. (0.17 Ac.)	1,195 S.F. (0.03 Ac.)	10,394 S.F. (0.24 Ac.)
CB 29	2,986 S.F. (0.07 Ac.)	0 S.F. (0.00 Ac.)	2,172 S.F. (0.05 Ac.)
CB 30	2,489 S.F. (0.06 Ac.)	0 S.F. (0.00 Ac.)	1,304 S.F. (0.03 Ac.)
CB 31	2,538 S.F. (0.06 Ac.)	1,424 S.F. (0.03 Ac.)	8,579 S.F. (0.20 Ac.)
RL 'A'	0 S.F. (0.00 Ac.)	19,624 S.F. (0.45 Ac.)	0 S.F. (0.00 Ac.)
RL 'B'	0 S.F. (0.00 Ac.)	26,933 S.F. (0.62 Ac.)	0 S.F. (0.00 Ac.)
TD 10A	1,967 S.F. (0.05 Ac.)	2,450 S.F. (0.06 Ac.)	0 S.F. (0.00 Ac.)
TD 13B	294 S.F. (0.01 Ac.)	2,103 S.F. (0.05 Ac.)	0 S.F. (0.00 Ac.)
TD 20A	3,280 S.F. (0.08 Ac.)	2,280 S.F. (0.05 Ac.)	0 S.F. (0.00 Ac.)

No.	Date	Description

Revisions:  
 No. Date Description

DA-3

DRAINAGE ANALYSIS PLAN  
 PIPE TO PIPE  
 PREPARED FOR  
**DORSET CROSSING, LLC**  
 CASTERIDGE CROSSING  
 SIMSBURY, CONNECTICUT

Date: 12-17-2021 Drawn by: DR7 Job no: 04174  
 Scale: 1" = 30' Checked by: DSZ Sheet no: 1 OF 1

F. A. Hesketh & Associates, Inc.  
 3 Creamery Brook, East Granby, CT 06026  
 Phone (860) 653-8000 Fax (860) 844-8800  
 www.fah.com info@fah.com  
 Civil & Traffic Engineers • Sewerage • Planners • Landscape Architects



# Hydrologic Analysis

## Hydraflow – Rational Method

12/17/2021

**DORSET CROSSING - CASTERBRIDGE CROSSING**  
 Simsbury, Connecticut  
**Storm Drain Systems**

<b>EXISTING</b>		<b>Woods</b>	<b>Landscape</b>	<b>Paved/Roof</b>	<b>Total</b>	<b>Woods</b>	<b>Landscape</b>	<b>Paved/Roof</b>	<b>Total</b>
<b>Area #</b>	<b>Area (S.F.)</b>	<b>Area (S.F.)</b>	<b>Area (S.F.)</b>	<b>Area (S.F.)</b>	<b>Area (S.F.)</b>	<b>Area (Acre)</b>	<b>Area (S.F.)</b>	<b>Area (Acre)</b>	<b>Area (Acre)</b>
EAST (EX.)	211105	0	11348	222453	4.85	0	0.26	5.11	
WEST (EX.)	107674	0	7005	114679	2.47	0	0.16	2.63	

<b>PROPOSED</b>		<b>Woods</b>	<b>Landscape</b>	<b>Paved/Roof</b>	<b>Total</b>	<b>Woods</b>	<b>Landscape</b>	<b>Paved/Roof</b>	<b>Total</b>
<b>Area #</b>	<b>Area (S.F.)</b>	<b>Area (S.F.)</b>	<b>Area (S.F.)</b>	<b>Area (S.F.)</b>	<b>Area (S.F.)</b>	<b>Area (Acre)</b>	<b>Area (S.F.)</b>	<b>Area (Acre)</b>	<b>Area (Acre)</b>
EAST UNDET. (PRO)	96875	17160	4393	118428	2.22	0.39	0.10	2.72	
EAST DET. 1 (PRO)	15060	18529	23748	57338	0.35	0.43	0.55	1.32	
EAST DET. 2 (PRO)	0	7881	31501	39383	0.00	0.18	0.72	0.90	
WEST UNDET. (PRO)	37379	23997	13175	74550	0.86	0.55	0.30	1.71	
WEST DET. 1 (PRO)	0	1725	15100	16825	0.00	0.04	0.35	0.39	
WEST DET. 2 (PRO)	0	3436	27127	30563	0.00	0.08	0.62	0.70	



# Watershed Model Schematic

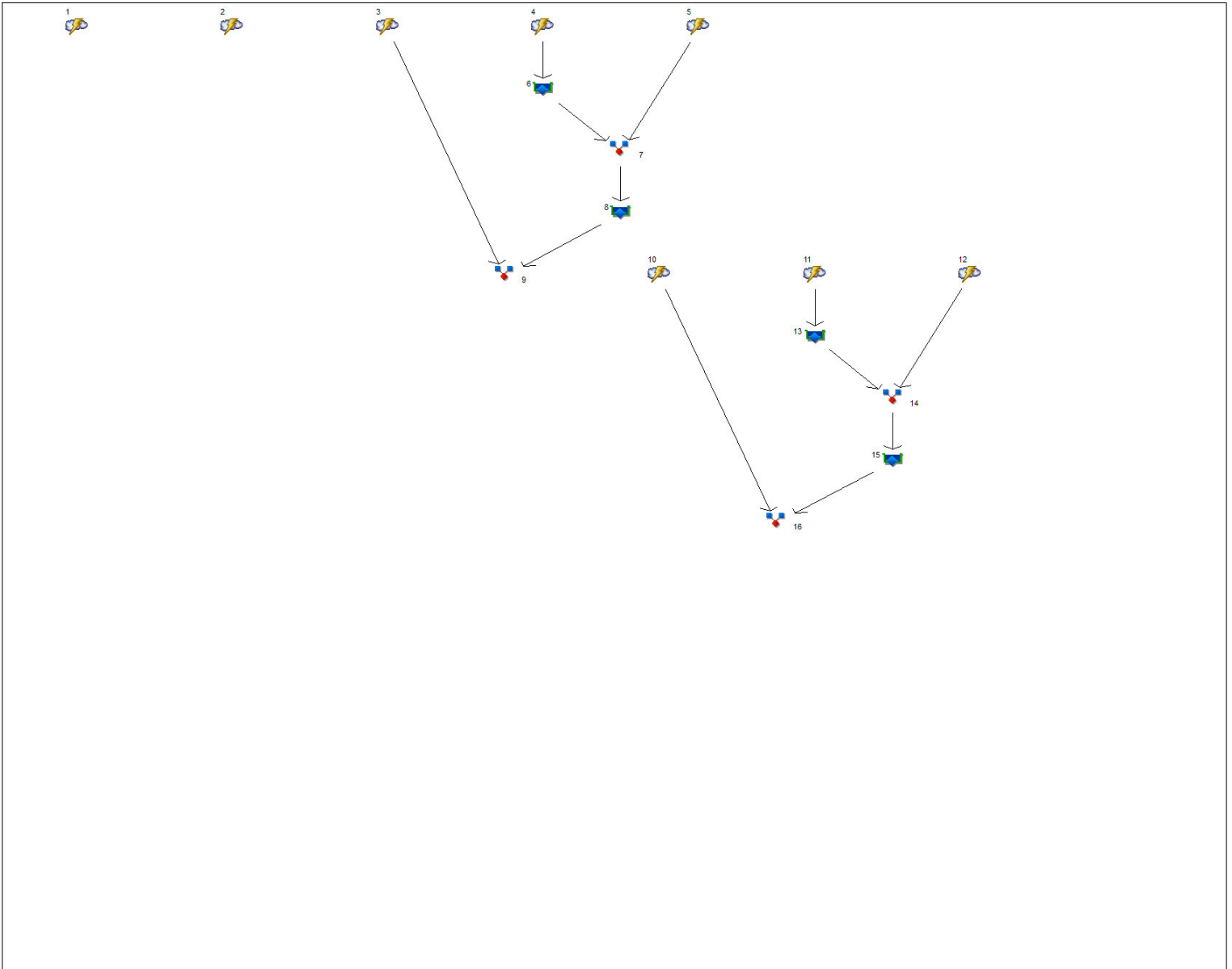

## Legend

Hyd.	Origin	Description
1	Rational	EAST (EX.)
2	Rational	WEST (EX)
3	Rational	EAST UNDET. (PRO.)
4	Rational	EAST DET.1 (PRO.)
5	Rational	EAST DET.2 (PRO.)
6	Reservoir	Outflow (U.G. Sys. 3)
7	Combine	Inflow (WQ Basin)
8	Reservoir	Outflow (WQ Basin)
9	Combine	TOTAL EAST (PRO)
10	Rational	WEST UNDET. (PRO.)
11	Rational	WEST DET.1 (PRO.)
12	Rational	WEST DET.2 (PRO.)
13	Reservoir	Outflow (U.G. Sys. 1)
14	Combine	Inflow (U.G. Sys. 2)
15	Reservoir	Outflow (U.G. Sys. 2)
16	Combine	TOTAL WEST (PRO)



# Hydrograph Return Period Recap

Hydraflow Hydrographs by Intelisolve v9.1

Hyd. No.	Hydrograph type (origin)	Inflow Hyd(s)	Peak Outflow (cfs)								Hydrograph description
			1-Yr	2-Yr	3-Yr	5-Yr	10-Yr	25-Yr	50-Yr	100-Yr	
1	Rational	-----	-----	7.093	-----	9.022	10.61	12.78	14.49	16.20	EAST (EX.)
2	Rational	-----	-----	3.395	-----	4.322	5.087	6.127	6.942	7.762	WEST (EX)
3	Rational	-----	-----	3.507	-----	4.460	5.243	6.318	7.165	8.007	EAST UNDET. (PRO.)
4	Rational	-----	-----	3.295	-----	4.185	4.909	5.920	6.726	7.509	EAST DET.1 (PRO.)
5	Rational	-----	-----	3.370	-----	4.280	5.021	6.055	6.879	7.680	EAST DET.2 (PRO.)
6	Reservoir	4	-----	0.000	-----	0.000	0.000	0.000	0.000	1.421	Outflow (U.G. Sys. 3)
7	Combine	5, 6	-----	3.370	-----	4.280	5.021	6.055	6.879	7.680	Inflow (WQ Basin)
8	Reservoir	7	-----	0.597	-----	0.788	0.890	1.010	1.098	1.213	Outflow (WQ Basin)
9	Combine	3, 8	-----	3.774	-----	4.985	5.908	7.139	8.061	8.972	TOTAL EAST (PRO)
10	Rational	-----	-----	2.646	-----	3.365	3.955	4.766	5.405	6.041	WEST UNDET. (PRO.)
11	Rational	-----	-----	1.580	-----	2.007	2.354	2.839	3.226	3.601	WEST DET.1 (PRO.)
12	Rational	-----	-----	2.874	-----	3.650	4.282	5.164	5.866	6.549	WEST DET.2 (PRO.)
13	Reservoir	11	-----	0.000	-----	0.000	0.000	0.000	0.000	1.231	Outflow (U.G. Sys. 1)
14	Combine	12, 13	-----	2.874	-----	3.650	4.282	5.164	5.866	6.549	Inflow (U.G. Sys. 2)
15	Reservoir	14	-----	0.816	-----	0.939	1.034	1.159	1.261	1.386	Outflow (U.G. Sys. 2)
16	Combine	10, 15	-----	3.372	-----	4.190	4.855	5.765	6.480	7.184	TOTAL WEST (PRO)

# Hydrograph Summary Report

Hydraflow Hydrographs by Intelisolve v9.1

Hyd. No.	Hydrograph type (origin)	Peak flow (cfs)	Time interval (min)	Time to peak (min)	Hyd. volume (cuft)	Inflow hyd(s)	Maximum elevation (ft)	Total strge used (cuft)	Hydrograph description	
1	Rational	7.093	1	7	4,156	---	-----	-----	EAST (EX.)	
2	Rational	3.395	1	9	2,445	---	-----	-----	WEST (EX)	
3	Rational	3.507	1	7	1,964	---	-----	-----	EAST UNDET. (PRO.)	
4	Rational	3.295	1	5	1,318	---	-----	-----	EAST DET.1 (PRO.)	
5	Rational	3.370	1	5	1,348	---	-----	-----	EAST DET.2 (PRO.)	
6	Reservoir	0.000	1	n/a	0	4	225.98	1,285	Outflow (U.G. Sys. 3)	
7	Combine	3.370	1	5	1,314	5, 6	-----	-----	Inflow (WQ Basin)	
8	Reservoir	0.597	1	12	760	7	212.66	1,136	Outflow (WQ Basin)	
9	Combine	3.774	1	7	2,654	3, 8	-----	-----	TOTAL EAST (PRO)	
10	Rational	2.646	1	7	1,482	---	-----	-----	WEST UNDET. (PRO.)	
11	Rational	1.580	1	5	632	---	-----	-----	WEST DET.1 (PRO.)	
12	Rational	2.874	1	5	1,150	---	-----	-----	WEST DET.2 (PRO.)	
13	Reservoir	0.000	1	n/a	0	11	235.96	616	Outflow (U.G. Sys. 1)	
14	Combine	2.874	1	5	1,121	12, 13	-----	-----	Inflow (U.G. Sys. 2)	
15	Reservoir	0.816	1	11	1,118	14	230.63	742	Outflow (U.G. Sys. 2)	
16	Combine	3.372	1	7	2,547	10, 15	-----	-----	TOTAL WEST (PRO)	
TAPESTRY-2021-12-17.gpw					Return Period: 2 Year			Friday, Dec 17, 2021		

# Hydrograph Report

Hydraflow Hydrographs by Intelisolve v9.1

Friday, Dec 17, 2021

## Hyd. No. 1

EAST (EX.)

Hydrograph type = Rational  
 Storm frequency = 2 yrs  
 Time interval = 1 min  
 Drainage area = 5.110 ac  
 Intensity = 4.206 in/hr  
 IDF Curve = IDF CURVE.IDF

Peak discharge = 7.093 cfs  
 Time to peak = 7 min  
 Hyd. volume = 4,156 cuft  
 Runoff coeff. = 0.33  
 Tc by TR55 = 7.32 min  
 Asc/Rec limb fact = 1/1.66667

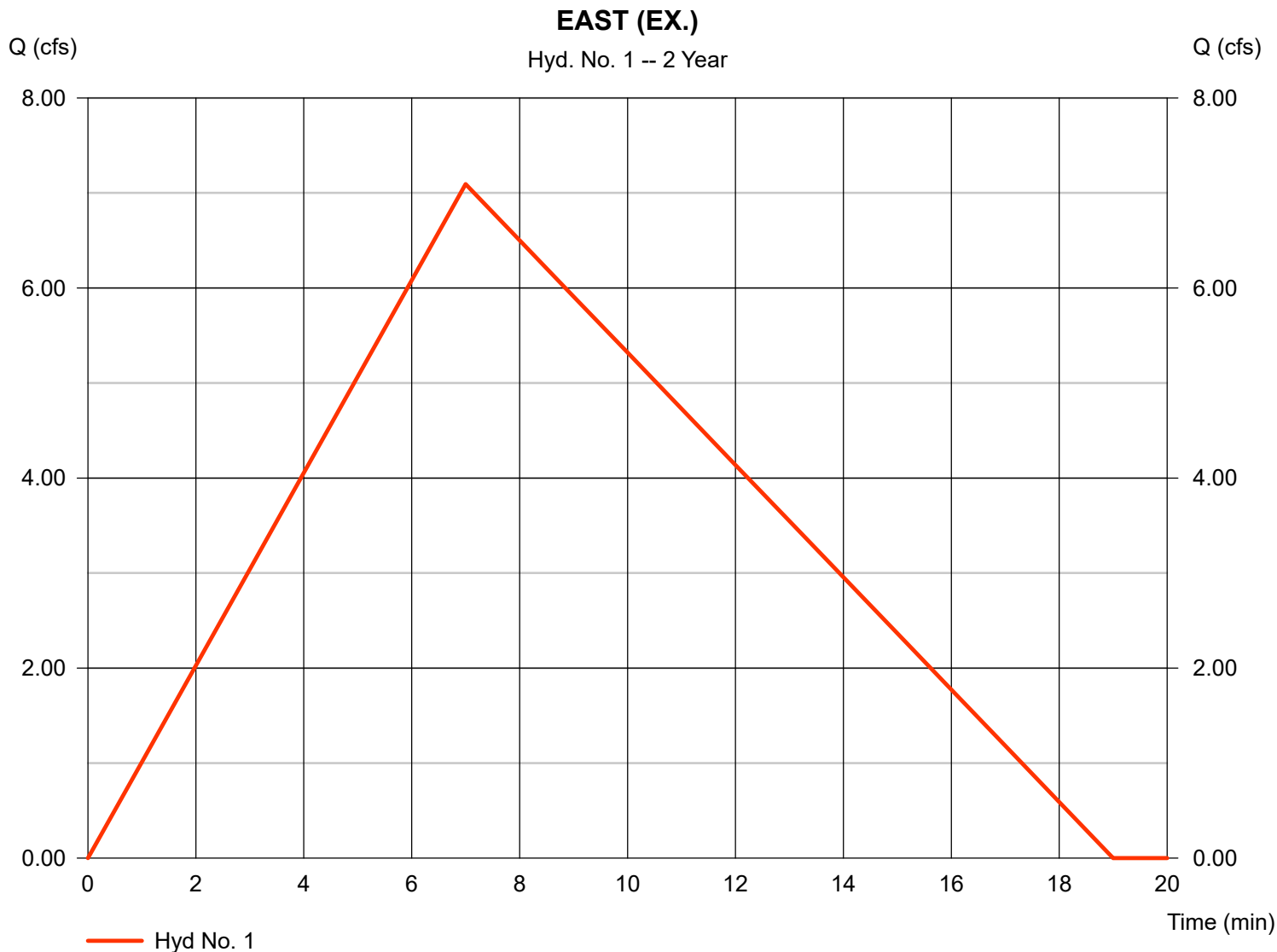

# TR55 Tc Worksheet

Hydraflow Hydrographs by Intelisolve v9.1

## Hyd. No. 1

EAST (EX.)

<u>Description</u>	<u>A</u>	<u>B</u>	<u>C</u>	<u>Totals</u>
<b>Sheet Flow</b>				
Manning's n-value	= 0.400	0.011	0.011	
Flow length (ft)	= 67.0	0.0	0.0	
Two-year 24-hr precip. (in)	= 3.29	0.00	0.00	
Land slope (%)	= 46.08	0.00	0.00	
<b>Travel Time (min)</b>	<b>= 4.38</b>	<b>+</b>	<b>0.00</b>	<b>+</b>
				<b>0.00</b>
				<b>= 4.38</b>
<b>Shallow Concentrated Flow</b>				
Flow length (ft)	= 709.00	0.00	0.00	
Watercourse slope (%)	= 6.20	0.00	0.00	
Surface description	= Unpaved	Paved	Paved	
Average velocity (ft/s)	= 4.02	0.00	0.00	
<b>Travel Time (min)</b>	<b>= 2.94</b>	<b>+</b>	<b>0.00</b>	<b>+</b>
				<b>0.00</b>
				<b>= 2.94</b>
<b>Channel Flow</b>				
X sectional flow area (sqft)	= 0.00	0.00	0.00	
Wetted perimeter (ft)	= 0.00	0.00	0.00	
Channel slope (%)	= 0.00	0.00	0.00	
Manning's n-value	= 0.015	0.015	0.015	
Velocity (ft/s)	= 0.00	0.00	0.00	
Flow length (ft)	= 0.0	0.0	0.0	
<b>Travel Time (min)</b>	<b>= 0.00</b>	<b>+</b>	<b>0.00</b>	<b>+</b>
				<b>0.00</b>
				<b>= 0.00</b>
<b>Total Travel Time, Tc</b> .....				<b>7.32 min</b>

# Hydrograph Report

Hydraflow Hydrographs by Intelisolve v9.1

Friday, Dec 17, 2021

## Hyd. No. 2

WEST (EX)

Hydrograph type = Rational  
 Storm frequency = 2 yrs  
 Time interval = 1 min  
 Drainage area = 2.630 ac  
 Intensity = 3.797 in/hr  
 IDF Curve = IDF CURVE.IDF

Peak discharge = 3.395 cfs  
 Time to peak = 9 min  
 Hyd. volume = 2,445 cuft  
 Runoff coeff. = 0.34  
 Tc by TR55 = 9.00 min  
 Asc/Rec limb fact = 1/1.66667

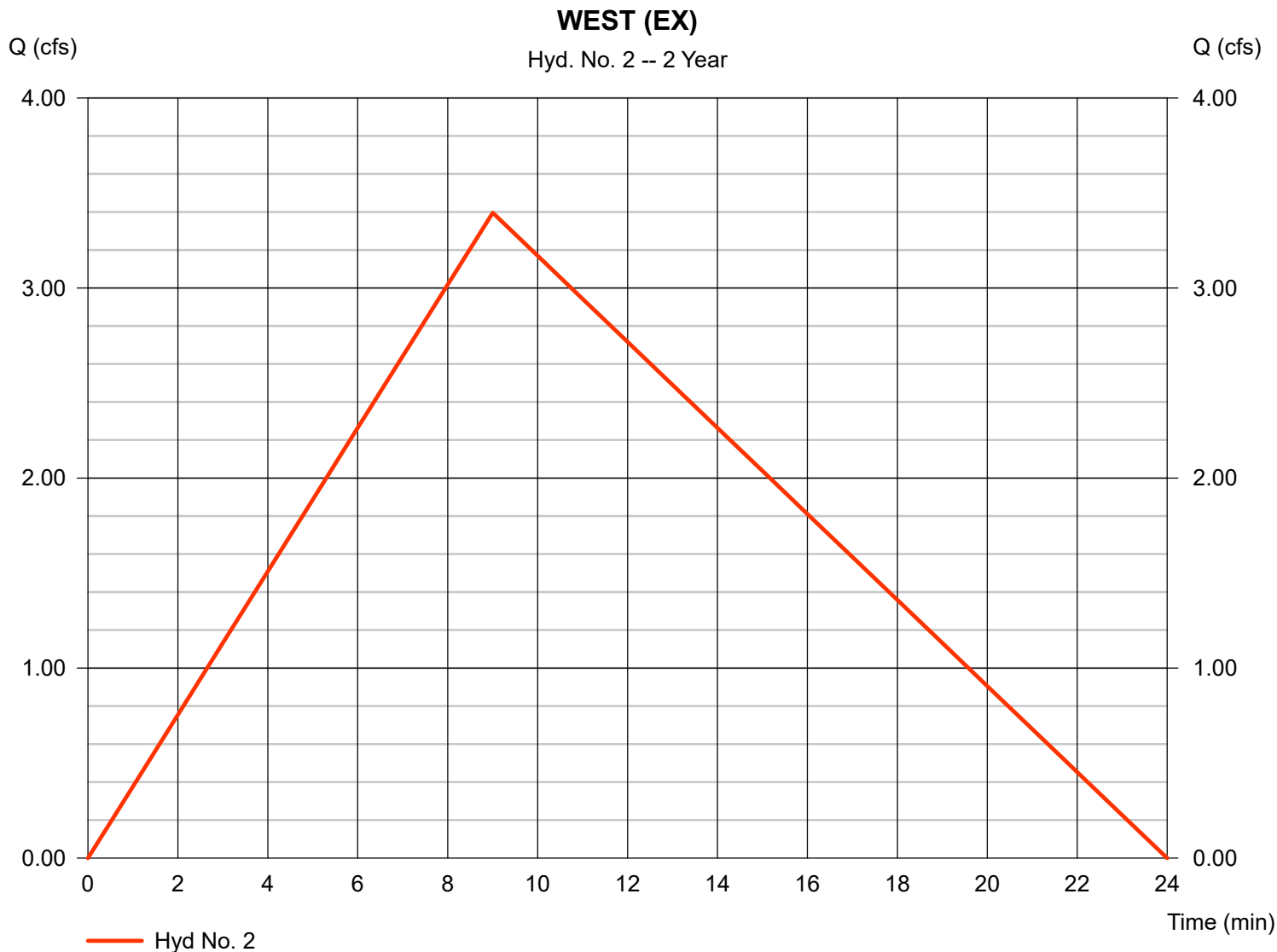

# TR55 Tc Worksheet

Hydraflow Hydrographs by Intelisolve v9.1

## Hyd. No. 2

WEST (EX)

<u>Description</u>	<u>A</u>	<u>B</u>	<u>C</u>	<u>Totals</u>
<b>Sheet Flow</b>				
Manning's n-value	= 0.400	0.011	0.011	
Flow length (ft)	= 103.0	0.0	0.0	
Two-year 24-hr precip. (in)	= 3.29	0.00	0.00	
Land slope (%)	= 31.35	0.00	0.00	
<b>Travel Time (min)</b>	<b>= 7.21</b>	<b>+</b> <b>0.00</b>	<b>+</b> <b>0.00</b>	<b>= 7.21</b>
<b>Shallow Concentrated Flow</b>				
Flow length (ft)	= 471.00	0.00	0.00	
Watercourse slope (%)	= 4.90	0.00	0.00	
Surface description	= Unpaved	Paved	Paved	
Average velocity (ft/s)	= 3.57	0.00	0.00	
<b>Travel Time (min)</b>	<b>= 2.20</b>	<b>+</b> <b>0.00</b>	<b>+</b> <b>0.00</b>	<b>= 2.20</b>
<b>Channel Flow</b>				
X sectional flow area (sqft)	= 0.00	0.00	0.00	
Wetted perimeter (ft)	= 0.00	0.00	0.00	
Channel slope (%)	= 0.00	0.00	0.00	
Manning's n-value	= 0.015	0.015	0.015	
Velocity (ft/s)	= 0.00	0.00	0.00	
Flow length (ft)	= 0.0	0.0	0.0	
<b>Travel Time (min)</b>	<b>= 0.00</b>	<b>+</b> <b>0.00</b>	<b>+</b> <b>0.00</b>	<b>= 0.00</b>
<b>Total Travel Time, Tc .....</b>				<b>9.00 min</b>

# Hydrograph Report

Hydraflow Hydrographs by Intelisolve v9.1

Friday, Dec 17, 2021

## Hyd. No. 3

EAST UNDET. (PRO.)

Hydrograph type = Rational  
 Storm frequency = 2 yrs  
 Time interval = 1 min  
 Drainage area = 2.720 ac  
 Intensity = 4.298 in/hr  
 IDF Curve = IDF CURVE.IDF

Peak discharge = 3.507 cfs  
 Time to peak = 7 min  
 Hyd. volume = 1,964 cuft  
 Runoff coeff. = 0.3  
 Tc by TR55 = 7.00 min  
 Asc/Rec limb fact = 1/1.66667

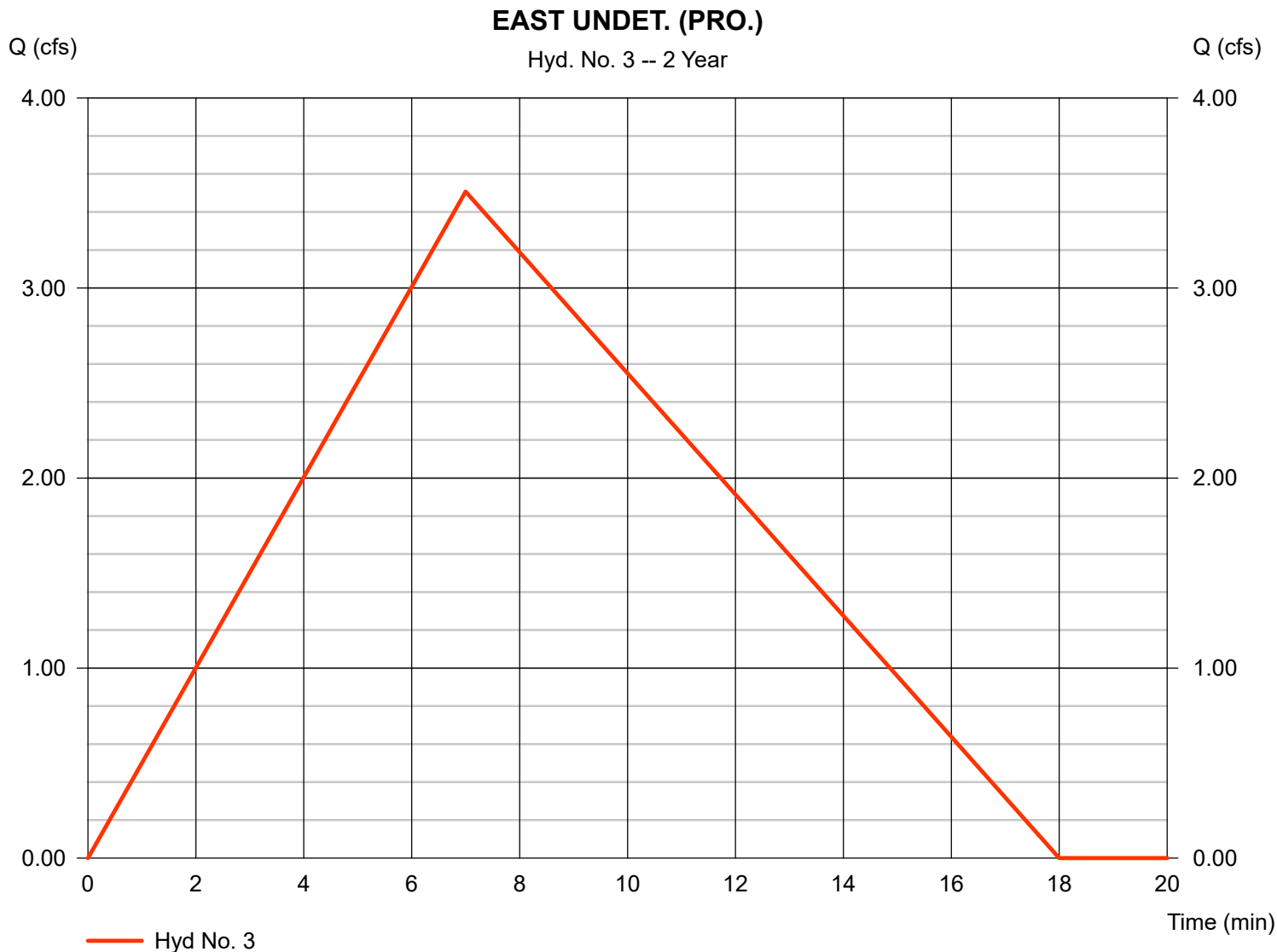

# TR55 Tc Worksheet

## Hyd. No. 3

EAST UNDET. (PRO.)

<u>Description</u>	<u>A</u>		<u>B</u>		<u>C</u>		<u>Totals</u>	
<b>Sheet Flow</b>								
Manning's n-value	= 0.400		0.011		0.011			
Flow length (ft)	= 55.0		0.0		0.0			
Two-year 24-hr precip. (in)	= 3.29		0.00		0.00			
Land slope (%)	= 25.00		0.00		0.00			
<b>Travel Time (min)</b>	<b>= 4.78</b>	<b>+</b>	<b>0.00</b>	<b>+</b>	<b>0.00</b>	<b>=</b>	<b>4.78</b>	
<b>Shallow Concentrated Flow</b>								
Flow length (ft)	= 145.00		376.00		0.00			
Watercourse slope (%)	= 25.00		5.00		0.00			
Surface description	= Unpaved		Unpaved		Paved			
Average velocity (ft/s)	= 8.07		3.61		0.00			
<b>Travel Time (min)</b>	<b>= 0.30</b>	<b>+</b>	<b>1.74</b>	<b>+</b>	<b>0.00</b>	<b>=</b>	<b>2.04</b>	
<b>Channel Flow</b>								
X sectional flow area (sqft)	= 0.00		0.00		0.00			
Wetted perimeter (ft)	= 0.00		0.00		0.00			
Channel slope (%)	= 0.00		0.00		0.00			
Manning's n-value	= 0.015		0.015		0.015			
Velocity (ft/s)	= 0.00		0.00		0.00			
Flow length (ft)	= 0.0		0.0		0.0			
<b>Travel Time (min)</b>	<b>= 0.00</b>	<b>+</b>	<b>0.00</b>	<b>+</b>	<b>0.00</b>	<b>=</b>	<b>0.00</b>	
<b>Total Travel Time, Tc .....</b>							<b>=</b>	<b>7.00 min</b>



# Hydrograph Report

Hydraflow Hydrographs by Intelisolve v9.1

Friday, Dec 17, 2021

## Hyd. No. 4

EAST DET.1 (PRO.)

Hydrograph type = Rational  
 Storm frequency = 2 yrs  
 Time interval = 1 min  
 Drainage area = 1.320 ac  
 Intensity = 4.993 in/hr  
 IDF Curve = IDF CURVE.IDF

Peak discharge = 3.295 cfs  
 Time to peak = 5 min  
 Hyd. volume = 1,318 cuft  
 Runoff coeff. = 0.5  
 Tc by User = 5.00 min  
 Asc/Rec limb fact = 1/1.66667

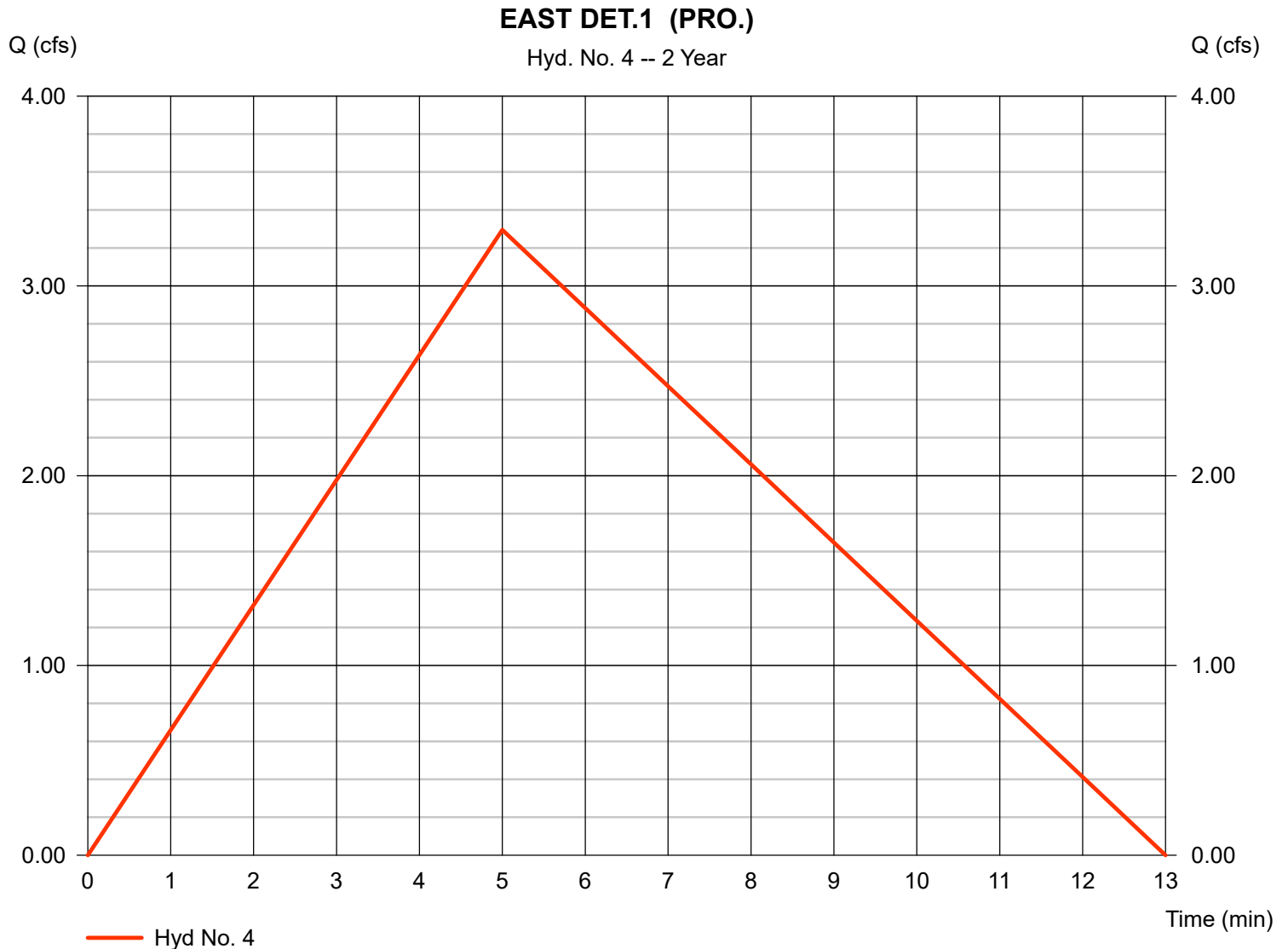

# Hydrograph Report

Hydraflow Hydrographs by Intelisolve v9.1

Friday, Dec 17, 2021

## Hyd. No. 5

EAST DET.2 (PRO.)

Hydrograph type = Rational  
 Storm frequency = 2 yrs  
 Time interval = 1 min  
 Drainage area = 0.900 ac  
 Intensity = 4.993 in/hr  
 IDF Curve = IDF CURVE.IDF

Peak discharge = 3.370 cfs  
 Time to peak = 5 min  
 Hyd. volume = 1,348 cuft  
 Runoff coeff. = 0.75  
 Tc by User = 5.00 min  
 Asc/Rec limb fact = 1/1.66667

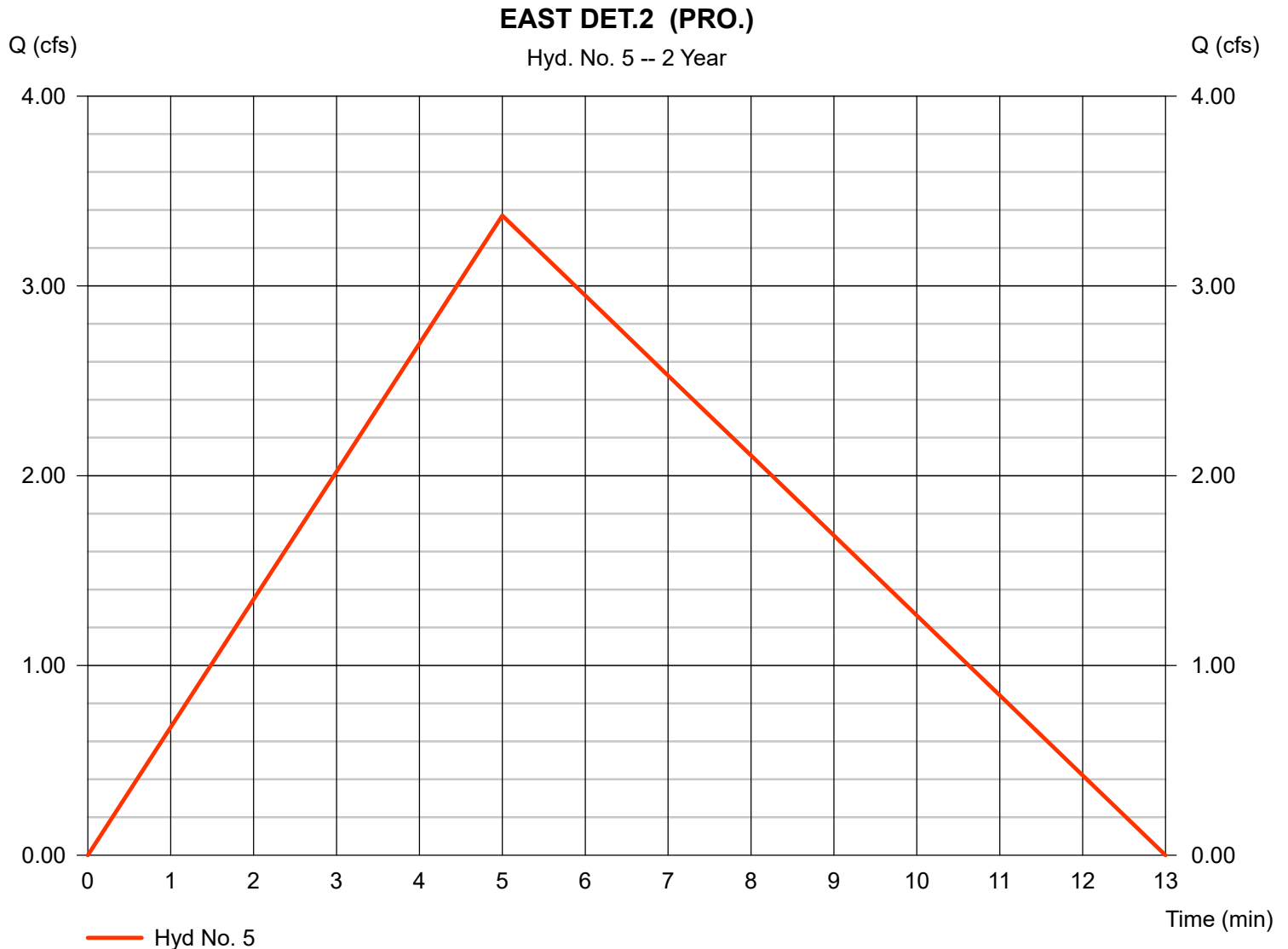

# Hydrograph Report

Hydraflow Hydrographs by Intelisolve v9.1

Friday, Dec 17, 2021

## Hyd. No. 6

Outflow (U.G. Sys. 3)

Hydrograph type	= Reservoir	Peak discharge	= 0.000 cfs
Storm frequency	= 2 yrs	Time to peak	= n/a
Time interval	= 1 min	Hyd. volume	= 0 cuft
Inflow hyd. No.	= 4 - EAST DET.1 (PRO.)	Max. Elevation	= 225.98 ft
Reservoir name	= U.G. STORAGE SYSTEM #3	Max. Storage	= 1,285 cuft

Storage Indication method used.

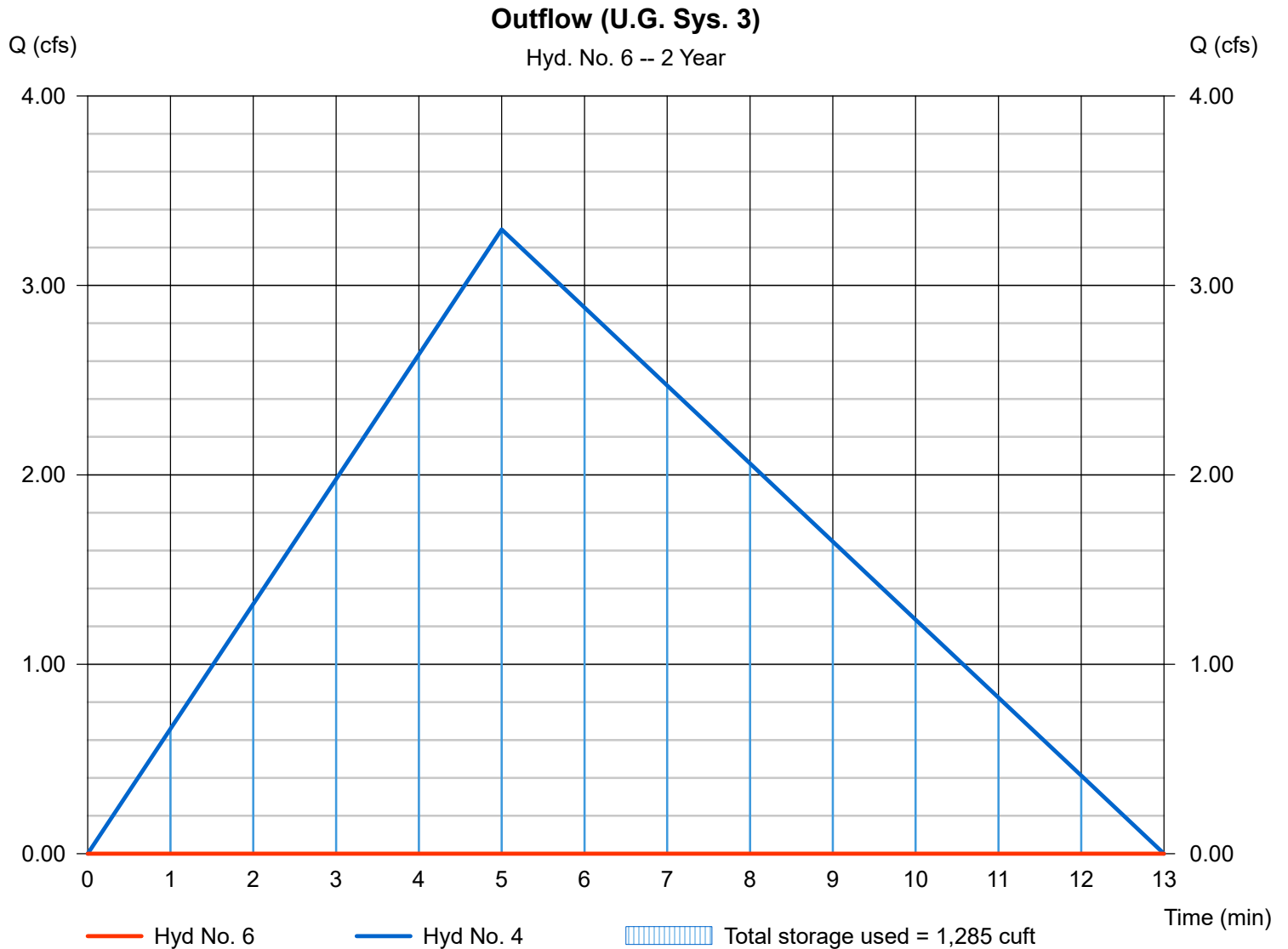



# Hydrograph Report

Hydraflow Hydrographs by Intelisolve v9.1

Friday, Dec 17, 2021

## Hyd. No. 7

Inflow (WQ Basin)

Hydrograph type = Combine  
 Storm frequency = 2 yrs  
 Time interval = 1 min  
 Inflow hyds. = 5, 6

Peak discharge = 3.370 cfs  
 Time to peak = 5 min  
 Hyd. volume = 1,314 cuft  
 Contrib. drain. area = 0.900 ac

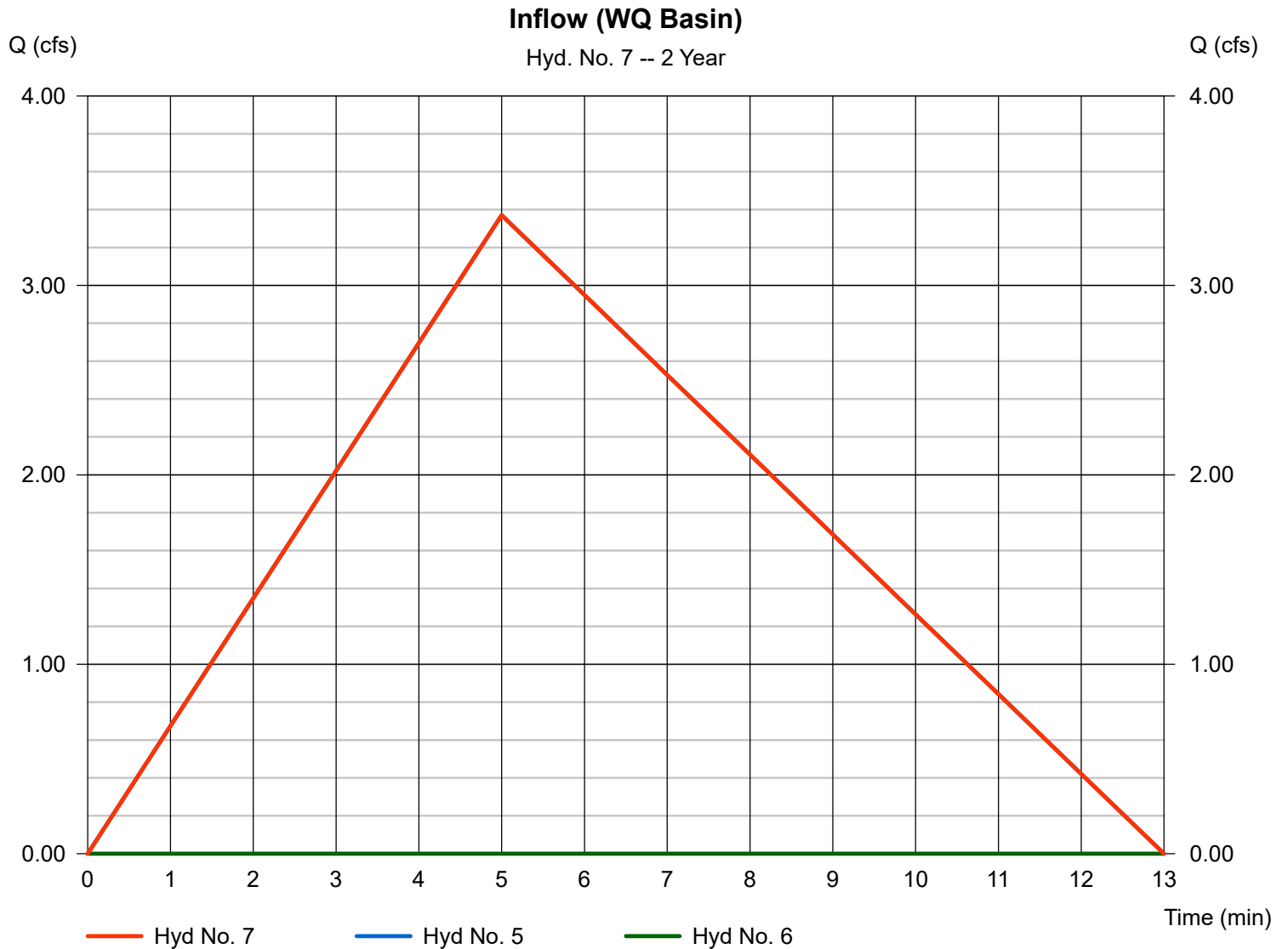

# Hydrograph Report

Hydraflow Hydrographs by Intelisolve v9.1

Friday, Dec 17, 2021

## Hyd. No. 8

Outflow (WQ Basin)

Hydrograph type = Reservoir  
 Storm frequency = 2 yrs  
 Time interval = 1 min  
 Inflow hyd. No. = 7 - Inflow (WQ Basin)  
 Reservoir name = WQ BASIN

Peak discharge = 0.597 cfs  
 Time to peak = 12 min  
 Hyd. volume = 760 cuft  
 Max. Elevation = 212.66 ft  
 Max. Storage = 1,136 cuft

Storage Indication method used.

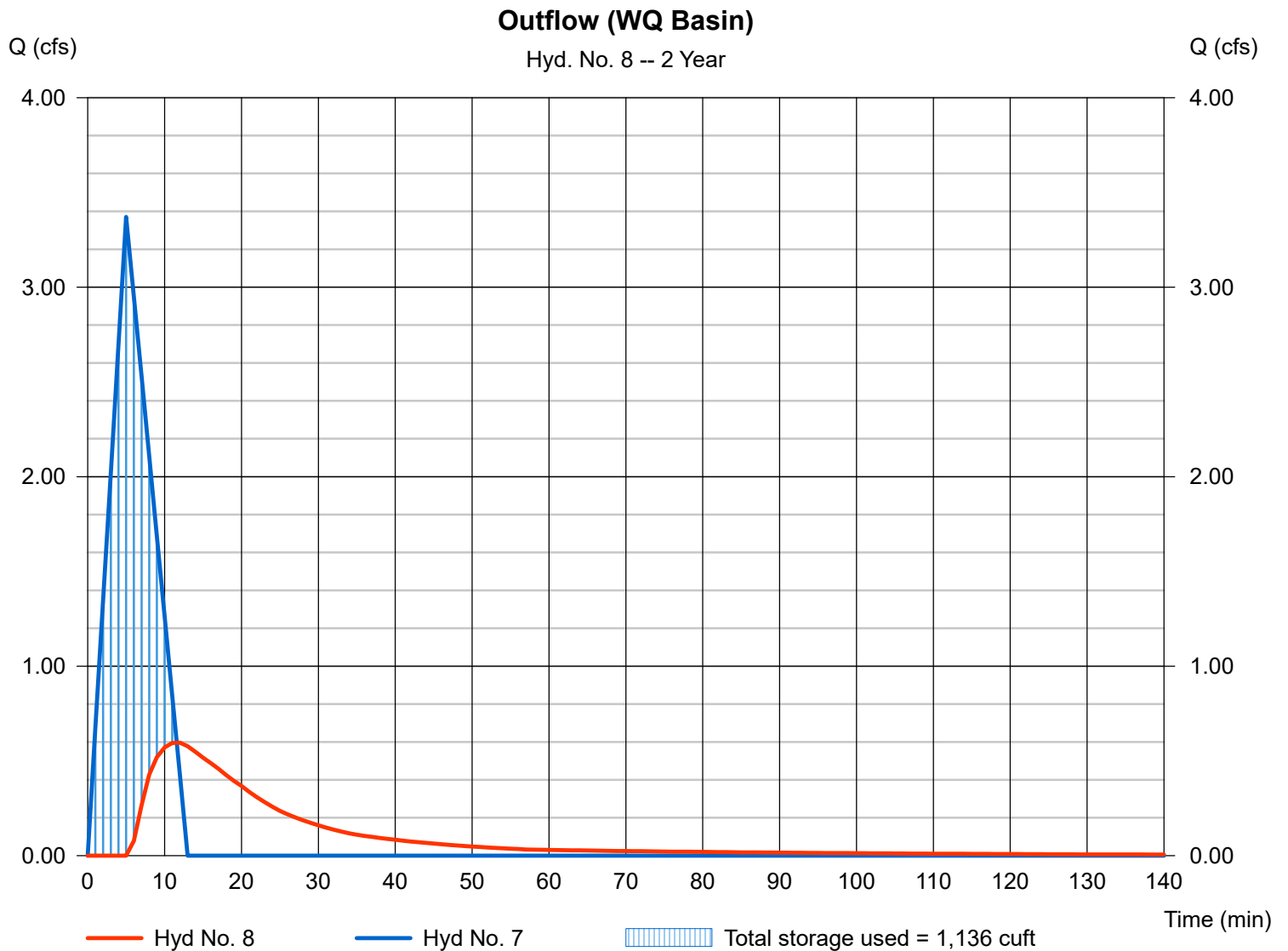



# Hydrograph Report

Hydraflow Hydrographs by Intelisolve v9.1

Friday, Dec 17, 2021

## Hyd. No. 9

TOTAL EAST (PRO)

Hydrograph type = Combine  
Storm frequency = 2 yrs  
Time interval = 1 min  
Inflow hyds. = 3, 8

Peak discharge = 3.774 cfs  
Time to peak = 7 min  
Hyd. volume = 2,654 cuft  
Contrib. drain. area = 2.720 ac

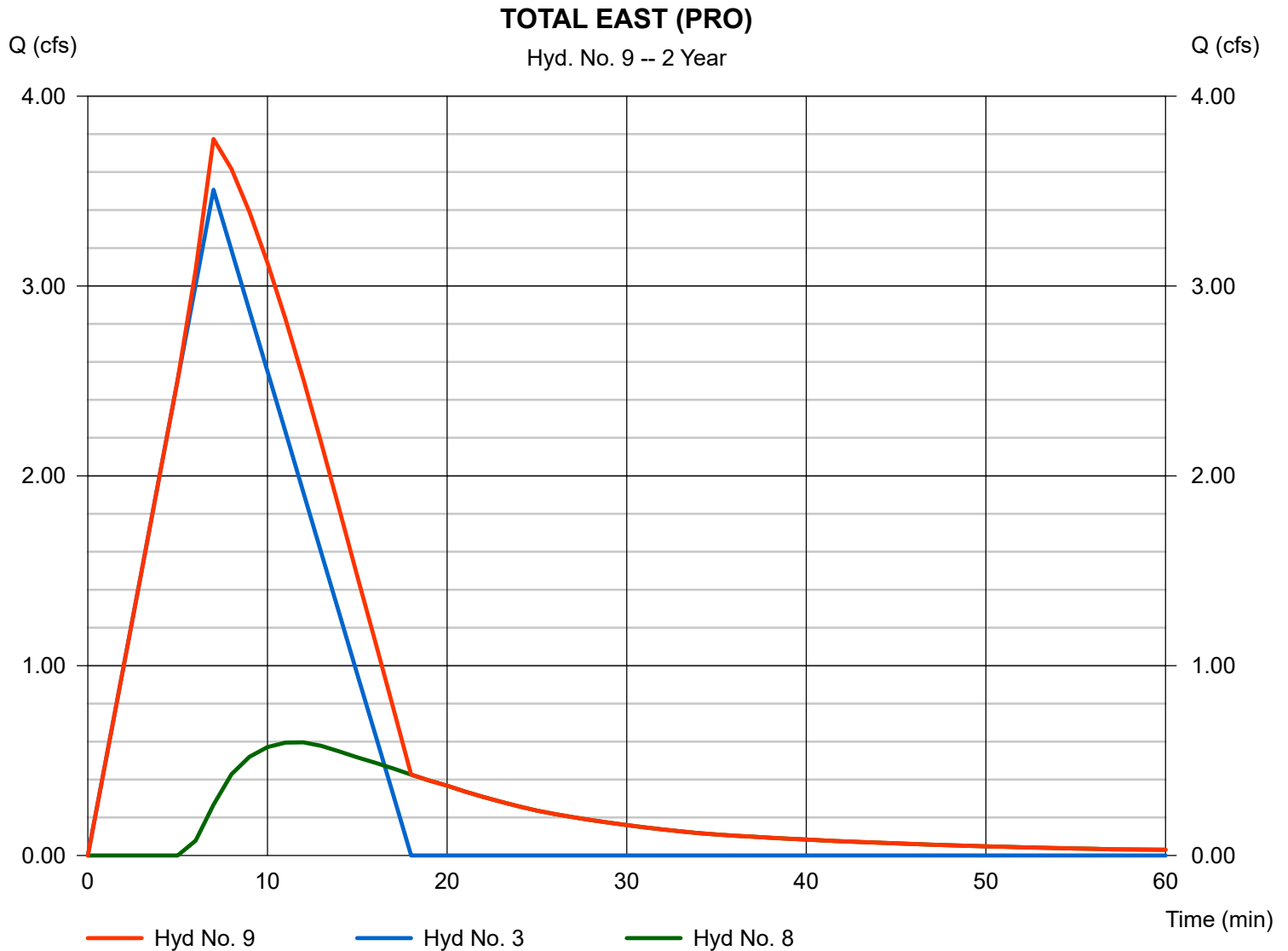



# Hydrograph Report

Hydraflow Hydrographs by Intelisolve v9.1

Friday, Dec 17, 2021

## Hyd. No. 10

WEST UNDET. (PRO.)

Hydrograph type = Rational  
 Storm frequency = 2 yrs  
 Time interval = 1 min  
 Drainage area = 1.710 ac  
 Intensity = 4.298 in/hr  
 IDF Curve = IDF CURVE.IDF

Peak discharge = 2.646 cfs  
 Time to peak = 7 min  
 Hyd. volume = 1,482 cuft  
 Runoff coeff. = 0.36  
 Tc by TR55 = 7.00 min  
 Asc/Rec limb fact = 1/1.66667

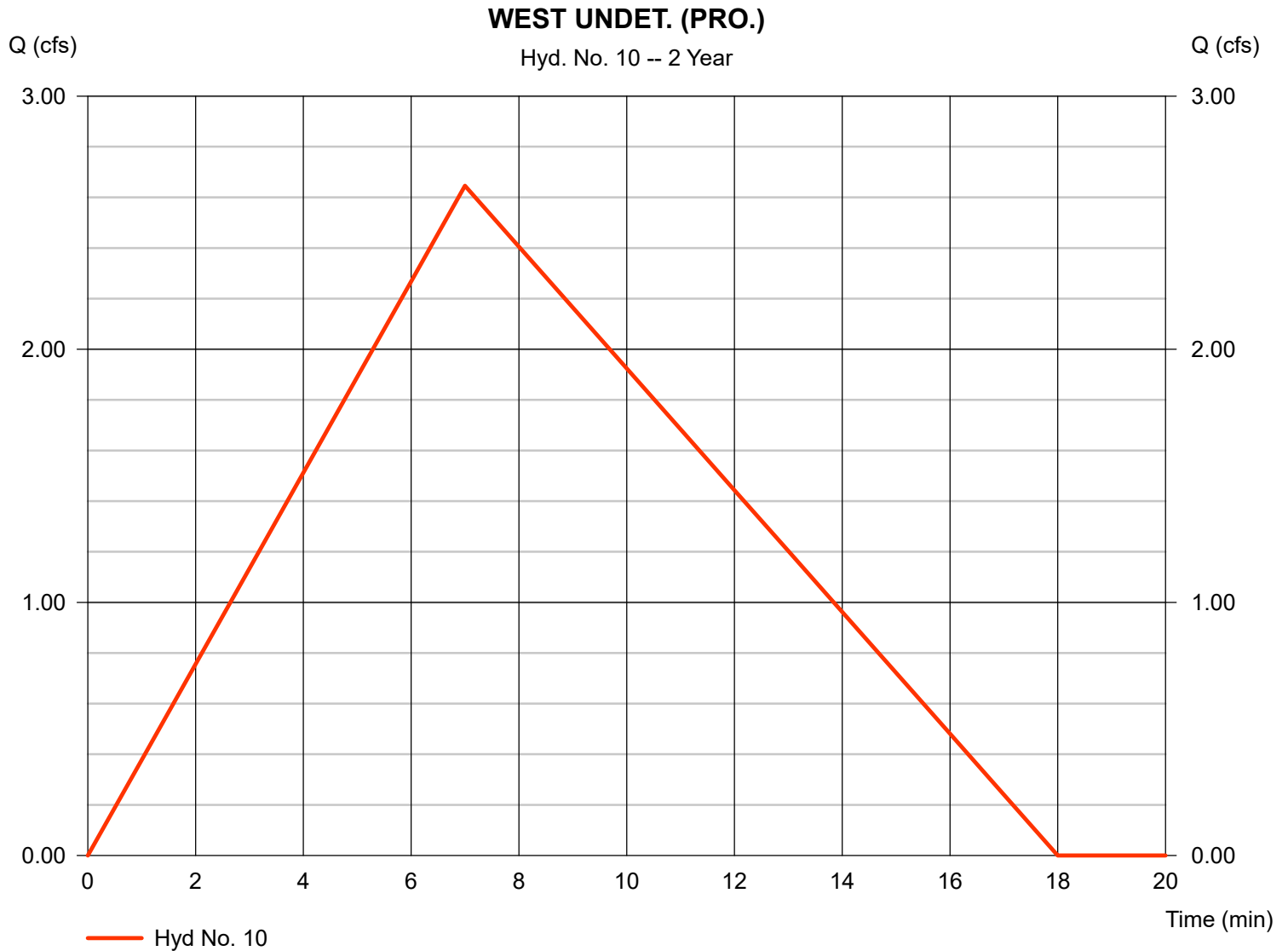

# TR55 Tc Worksheet

Hydraflow Hydrographs by Intelisolve v9.1

## Hyd. No. 10

WEST UNDET. (PRO.)

<u>Description</u>	<u>A</u>	<u>B</u>	<u>C</u>	<u>Totals</u>
<b>Sheet Flow</b>				
Manning's n-value	= 0.400	0.011	0.011	
Flow length (ft)	= 65.0	0.0	0.0	
Two-year 24-hr precip. (in)	= 3.29	0.00	0.00	
Land slope (%)	= 30.00	0.00	0.00	
<b>Travel Time (min)</b>	<b>= 5.08</b>	<b>+</b>	<b>0.00</b>	<b>+</b>
				<b>0.00</b>
				<b>= 5.08</b>
<b>Shallow Concentrated Flow</b>				
Flow length (ft)	= 50.00	69.00	0.00	
Watercourse slope (%)	= 30.00	1.00	0.00	
Surface description	= Unpaved	Unpaved	Paved	
Average velocity (ft/s)	= 8.84	1.61	0.00	
<b>Travel Time (min)</b>	<b>= 0.09</b>	<b>+</b>	<b>0.71</b>	<b>+</b>
				<b>0.00</b>
				<b>= 0.81</b>
<b>Channel Flow</b>				
X sectional flow area (sqft)	= 1.22	0.00	0.00	
Wetted perimeter (ft)	= 3.75	0.00	0.00	
Channel slope (%)	= 2.00	0.00	0.00	
Manning's n-value	= 0.013	0.015	0.015	
Velocity (ft/s)	= 7.64	0.00	0.00	
Flow length (ft)	= 466.0	0.0	0.0	
<b>Travel Time (min)</b>	<b>= 1.02</b>	<b>+</b>	<b>0.00</b>	<b>+</b>
				<b>0.00</b>
				<b>= 1.02</b>
<b>Total Travel Time, Tc</b> .....				<b>7.00 min</b>

# Hydrograph Report

Hydraflow Hydrographs by Intelisolve v9.1

Friday, Dec 17, 2021

## Hyd. No. 11

WEST DET.1 (PRO.)

Hydrograph type = Rational  
Storm frequency = 2 yrs  
Time interval = 1 min  
Drainage area = 0.386 ac  
Intensity = 4.993 in/hr  
IDF Curve = IDF CURVE.IDF

Peak discharge = 1.580 cfs  
Time to peak = 5 min  
Hyd. volume = 632 cuft  
Runoff coeff. = 0.82  
Tc by User = 5.00 min  
Asc/Rec limb fact = 1/1.66667



# Hydrograph Report

Hydraflow Hydrographs by Intelisolve v9.1

Friday, Dec 17, 2021

## Hyd. No. 12

WEST DET.2 (PRO.)

Hydrograph type = Rational  
Storm frequency = 2 yrs  
Time interval = 1 min  
Drainage area = 0.702 ac  
Intensity = 4.993 in/hr  
IDF Curve = IDF CURVE.IDF

Peak discharge = 2.874 cfs  
Time to peak = 5 min  
Hyd. volume = 1,150 cuft  
Runoff coeff. = 0.82  
Tc by User = 5.00 min  
Asc/Rec limb fact = 1/1.66667

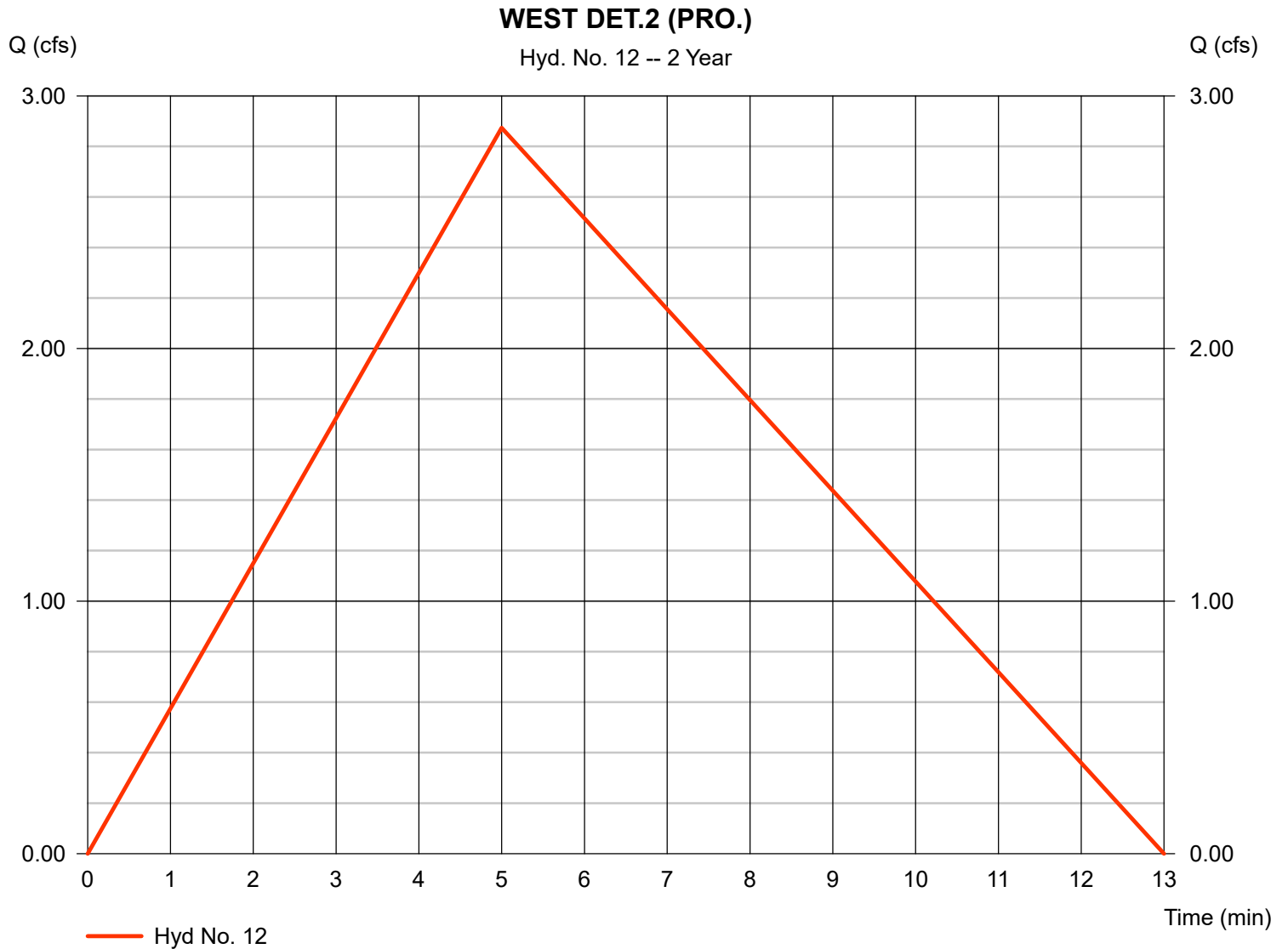

# Hydrograph Report

Hydraflow Hydrographs by Intelisolve v9.1

Friday, Dec 17, 2021

## Hyd. No. 13

Outflow (U.G. Sys. 1)

Hydrograph type	= Reservoir	Peak discharge	= 0.000 cfs
Storm frequency	= 2 yrs	Time to peak	= n/a
Time interval	= 1 min	Hyd. volume	= 0 cuft
Inflow hyd. No.	= 11 - WEST DET.1 (PRO.)	Max. Elevation	= 235.96 ft
Reservoir name	= U.G. STORAGE SYSTEM #1	Max. Storage	= 616 cuft

Storage Indication method used.

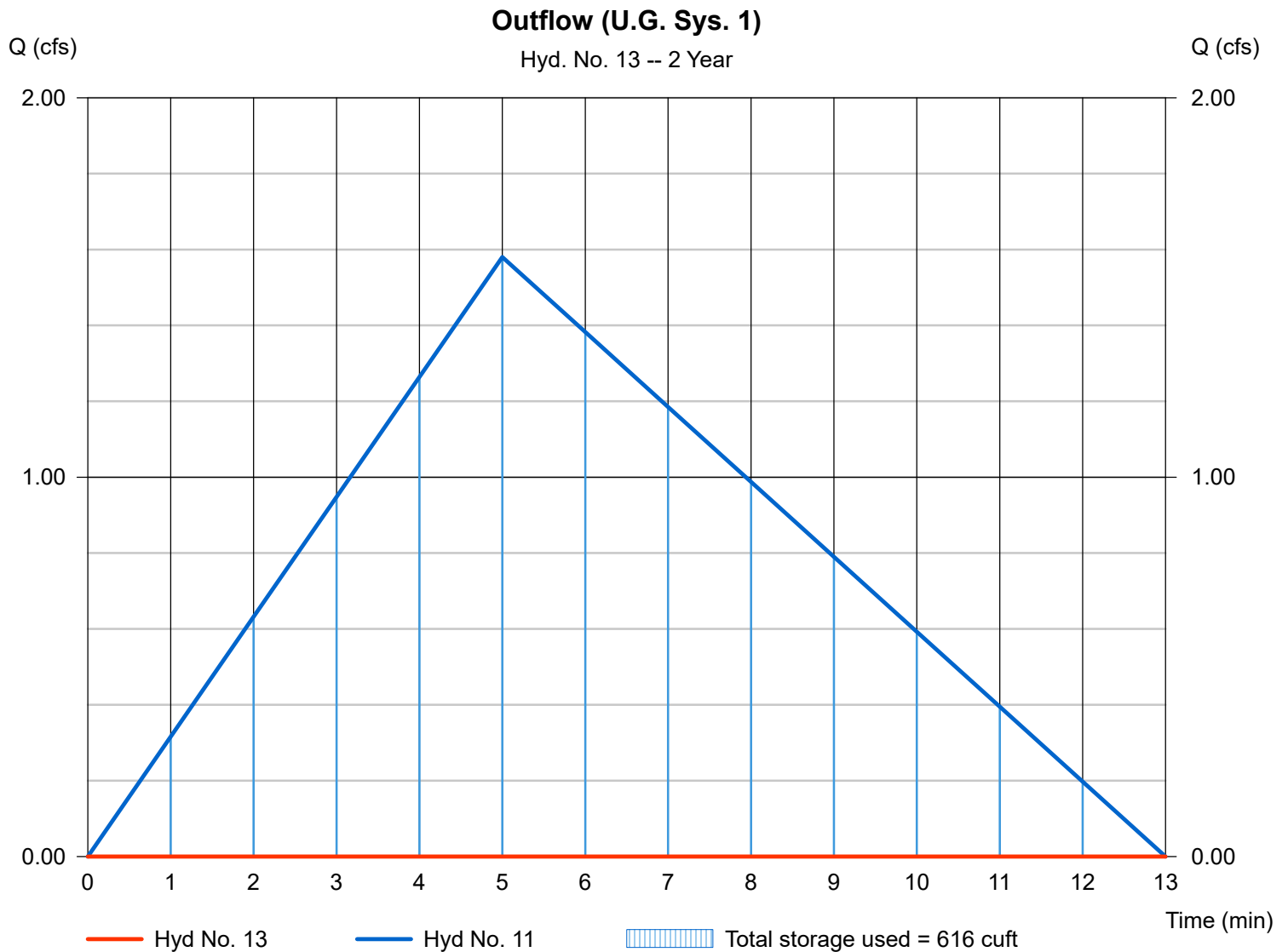



# Hydrograph Report

Hydraflow Hydrographs by Intelisolve v9.1

Friday, Dec 17, 2021

## Hyd. No. 14

Inflow (U.G. Sys. 2)

Hydrograph type = Combine  
Storm frequency = 2 yrs  
Time interval = 1 min  
Inflow hyds. = 12, 13

Peak discharge = 2.874 cfs  
Time to peak = 5 min  
Hyd. volume = 1,121 cuft  
Contrib. drain. area = 0.702 ac

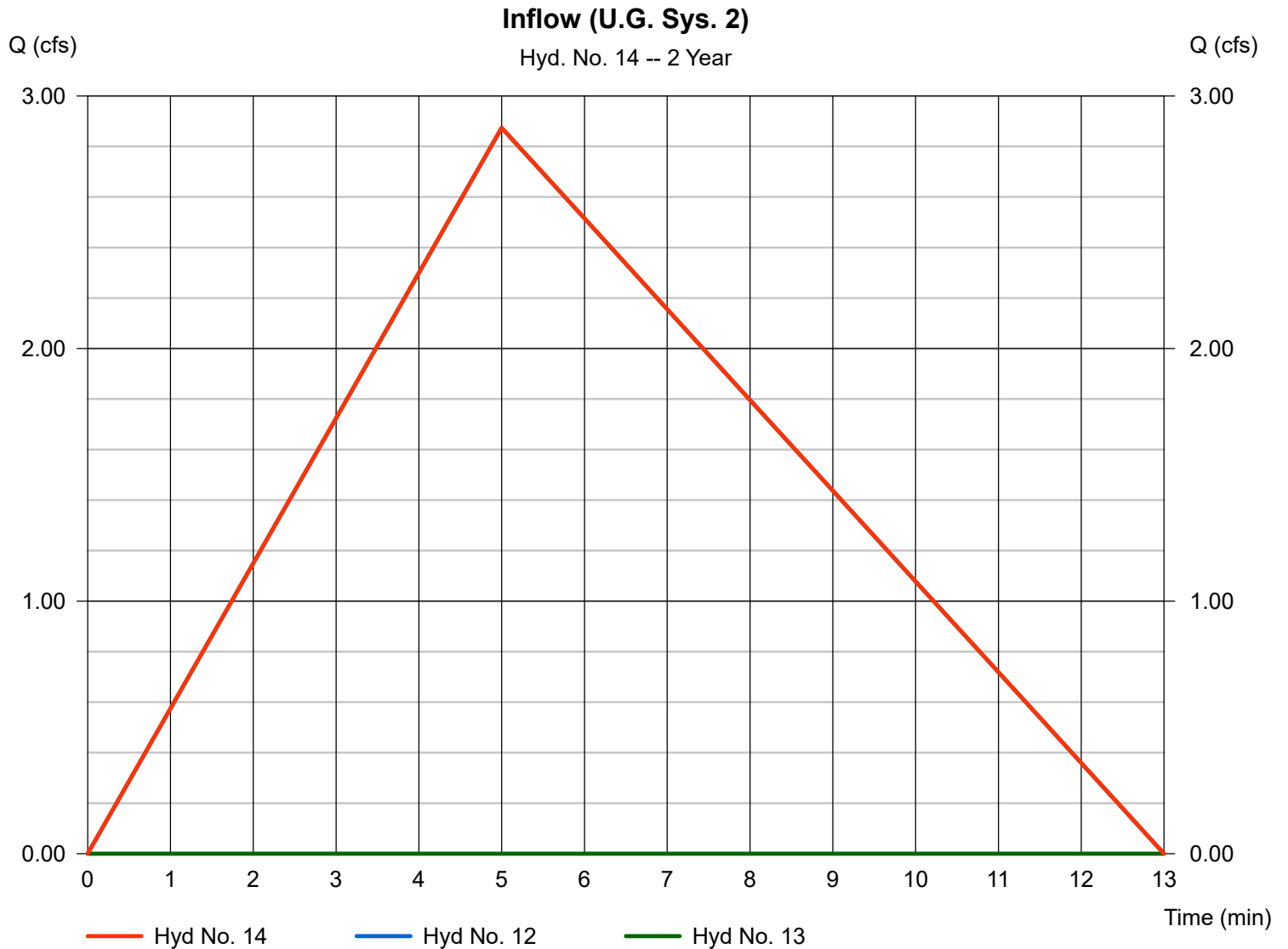

# Hydrograph Report

Hydraflow Hydrographs by Intelisolve v9.1

Friday, Dec 17, 2021

## Hyd. No. 15

Outflow (U.G. Sys. 2)

Hydrograph type	= Reservoir	Peak discharge	= 0.816 cfs
Storm frequency	= 2 yrs	Time to peak	= 11 min
Time interval	= 1 min	Hyd. volume	= 1,118 cuft
Inflow hyd. No.	= 14 - Inflow (U.G. Sys. 2)	Max. Elevation	= 230.63 ft
Reservoir name	= U.G. STORAGE SYSTEM #2	Max. Storage	= 742 cuft

Storage Indication method used.

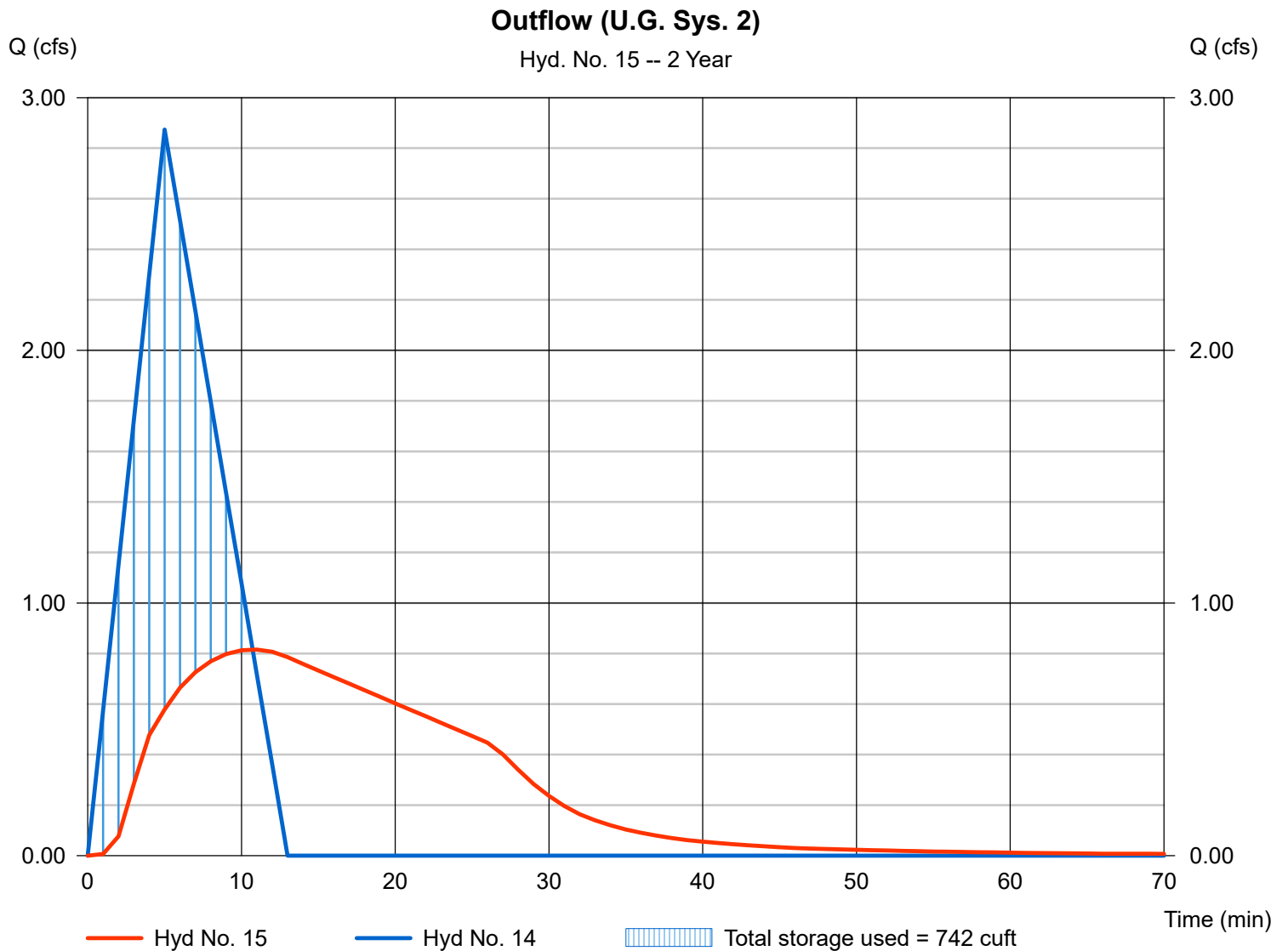



## Pond No. 3 - U.G. STORAGE SYSTEM #2

### Pond Data

Pond storage is based on user-defined values.

### Stage / Storage Table

Stage (ft)	Elevation (ft)	Contour area (sqft)	Incr. Storage (cuft)	Total storage (cuft)
0.00	229.50	n/a	0	0
0.50	230.00	n/a	203	203
1.00	230.50	n/a	436	639
1.50	231.00	n/a	418	1,057
2.00	231.50	n/a	389	1,446
2.50	232.00	n/a	344	1,790
3.00	232.50	n/a	254	2,044
3.50	233.00	n/a	203	2,247
4.00	233.50	n/a	3	2,250

### Culvert / Orifice Structures

	[A]	[B]	[C]	[PrfRsr]
Rise (in)	= 15.00	5.75	0.00	0.00
Span (in)	= 15.00	5.75	0.00	0.00
No. Barrels	= 1	1	0	0
Invert El. (ft)	= 228.79	229.50	0.00	0.00
Length (ft)	= 46.00	0.00	0.00	0.00
Slope (%)	= 0.50	0.00	0.00	n/a
N-Value	= .013	.013	.013	n/a
Orifice Coeff.	= 0.60	0.60	0.60	0.60
Multi-Stage	= n/a	Yes	No	No

### Weir Structures

	[A]	[B]	[C]	[D]
Crest Len (ft)	= 3.00	0.00	0.00	0.00
Crest El. (ft)	= 232.50	0.00	0.00	0.00
Weir Coeff.	= 3.33	3.33	3.33	3.33
Weir Type	= Rect	---	---	---
Multi-Stage	= Yes	No	No	No
Exfil.(in/hr)	= 0.000	(by Wet area)		
TW Elev. (ft)	= 0.00			

Note: Culvert/Orifice outflows are analyzed under inlet (ic) and outlet (oc) control. Weir risers checked for orifice conditions (ic) and submergence (s).

### Stage / Storage / Discharge Table

Stage ft	Storage cuft	Elevation ft	Clv A cfs	Clv B cfs	Clv C cfs	PrfRsr cfs	Wr A cfs	Wr B cfs	Wr C cfs	Wr D cfs	Exfil cfs	User cfs	Total cfs
0.00	0	229.50	0.00	0.00	---	---	0.00	---	---	---	---	---	0.00
0.50	203	230.00	1.78 oc	0.44 ic	---	---	0.00	---	---	---	---	---	0.44
1.00	639	230.50	1.78 oc	0.76 ic	---	---	0.00	---	---	---	---	---	0.76
1.50	1,057	231.00	1.78 oc	0.97 ic	---	---	0.00	---	---	---	---	---	0.97
2.00	1,446	231.50	1.78 oc	1.15 ic	---	---	0.00	---	---	---	---	---	1.15
2.50	1,790	232.00	1.78 oc	1.31 ic	---	---	0.00	---	---	---	---	---	1.31
3.00	2,044	232.50	1.78 oc	1.44 ic	---	---	0.00	---	---	---	---	---	1.44
3.50	2,247	233.00	4.92 oc	1.39 ic	---	---	3.53	---	---	---	---	---	4.92
4.00	2,250	233.50	10.45 oc	0.78 ic	---	---	9.66 s	---	---	---	---	---	10.45

# Hydrograph Report

Hydraflow Hydrographs by Intelisolve v9.1

Friday, Dec 17, 2021

## Hyd. No. 16

TOTAL WEST (PRO)

Hydrograph type = Combine  
Storm frequency = 2 yrs  
Time interval = 1 min  
Inflow hyds. = 10, 15

Peak discharge = 3.372 cfs  
Time to peak = 7 min  
Hyd. volume = 2,547 cuft  
Contrib. drain. area = 1.710 ac

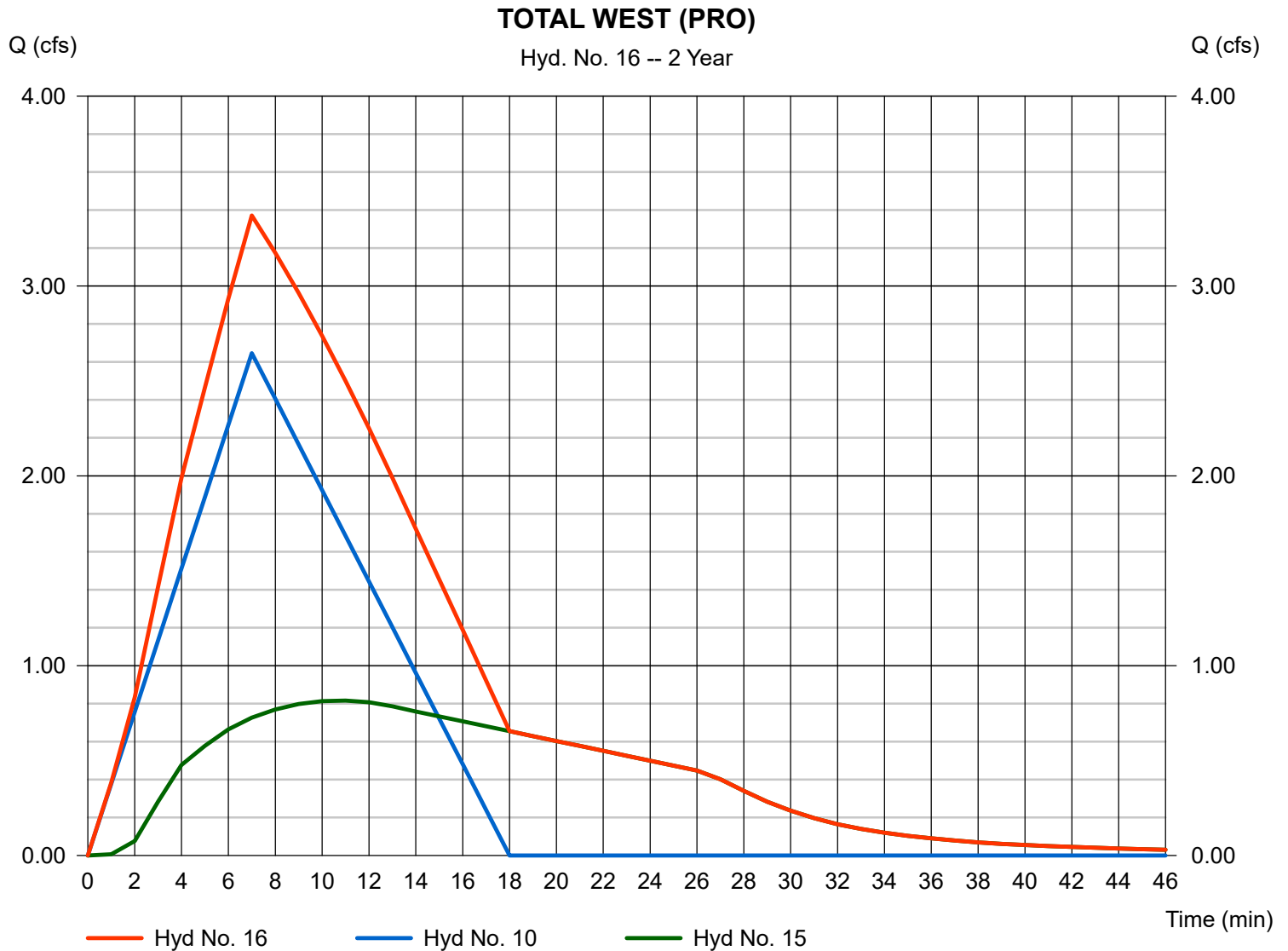

# Hydrograph Summary Report

Hydraflow Hydrographs by Intelisolve v9.1

Hyd. No.	Hydrograph type (origin)	Peak flow (cfs)	Time interval (min)	Time to peak (min)	Hyd. volume (cuft)	Inflow hyd(s)	Maximum elevation (ft)	Total strge used (cuft)	Hydrograph description	
1	Rational	9.022	1	7	5,286	---	-----	-----	EAST (EX.)	
2	Rational	4.322	1	9	3,112	---	-----	-----	WEST (EX)	
3	Rational	4.460	1	7	2,498	---	-----	-----	EAST UNDET. (PRO.)	
4	Rational	4.185	1	5	1,674	---	-----	-----	EAST DET.1 (PRO.)	
5	Rational	4.280	1	5	1,712	---	-----	-----	EAST DET.2 (PRO.)	
6	Reservoir	0.000	1	n/a	0	4	226.34	1,632	Outflow (U.G. Sys. 3)	
7	Combine	4.280	1	5	1,669	5, 6	-----	-----	Inflow (WQ Basin)	
8	Reservoir	0.788	1	12	1,115	7	212.95	1,403	Outflow (WQ Basin)	
9	Combine	4.985	1	7	3,524	3, 8	-----	-----	TOTAL EAST (PRO)	
10	Rational	3.365	1	7	1,884	---	-----	-----	WEST UNDET. (PRO.)	
11	Rational	2.007	1	5	803	---	-----	-----	WEST DET.1 (PRO.)	
12	Rational	3.650	1	5	1,460	---	-----	-----	WEST DET.2 (PRO.)	
13	Reservoir	0.000	1	n/a	0	11	236.32	783	Outflow (U.G. Sys. 1)	
14	Combine	3.650	1	5	1,423	12, 13	-----	-----	Inflow (U.G. Sys. 2)	
15	Reservoir	0.939	1	11	1,421	14	230.91	981	Outflow (U.G. Sys. 2)	
16	Combine	4.190	1	7	3,238	10, 15	-----	-----	TOTAL WEST (PRO)	
TAPESTRY-2021-12-17.gpw					Return Period: 5 Year			Friday, Dec 17, 2021		

# Hydrograph Report

Hydraflow Hydrographs by Intelisolve v9.1

Friday, Dec 17, 2021

## Hyd. No. 1

EAST (EX.)

Hydrograph type = Rational  
 Storm frequency = 5 yrs  
 Time interval = 1 min  
 Drainage area = 5.110 ac  
 Intensity = 5.350 in/hr  
 IDF Curve = IDF CURVE.IDF

Peak discharge = 9.022 cfs  
 Time to peak = 7 min  
 Hyd. volume = 5,286 cuft  
 Runoff coeff. = 0.33  
 Tc by TR55 = 7.32 min  
 Asc/Rec limb fact = 1/1.66667

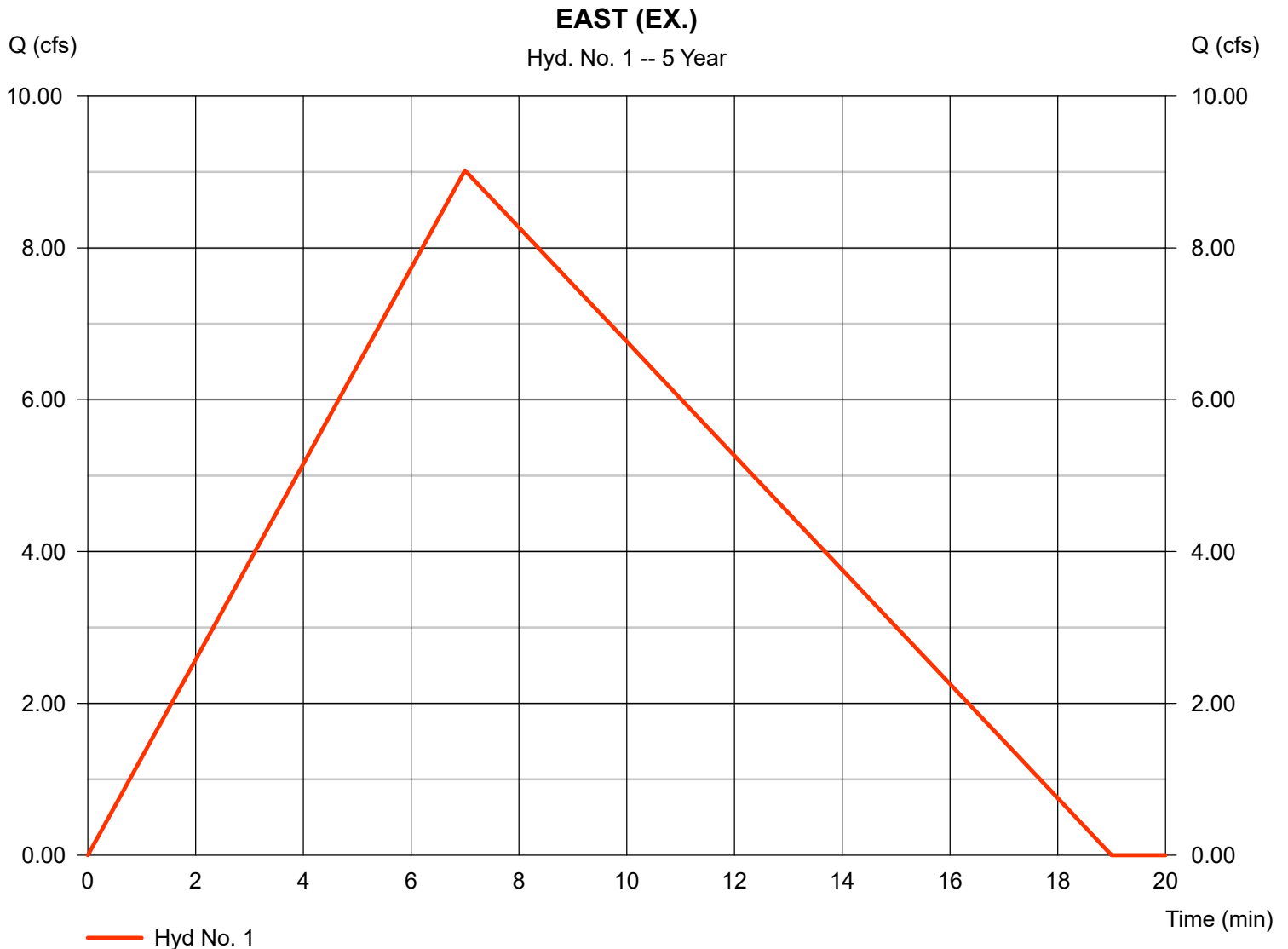

# Hydrograph Report

Hydraflow Hydrographs by Intelisolve v9.1

Friday, Dec 17, 2021

## Hyd. No. 2

WEST (EX)

Hydrograph type = Rational  
Storm frequency = 5 yrs  
Time interval = 1 min  
Drainage area = 2.630 ac  
Intensity = 4.834 in/hr  
IDF Curve = IDF CURVE.IDF

Peak discharge = 4.322 cfs  
Time to peak = 9 min  
Hyd. volume = 3,112 cuft  
Runoff coeff. = 0.34  
Tc by TR55 = 9.00 min  
Asc/Rec limb fact = 1/1.66667

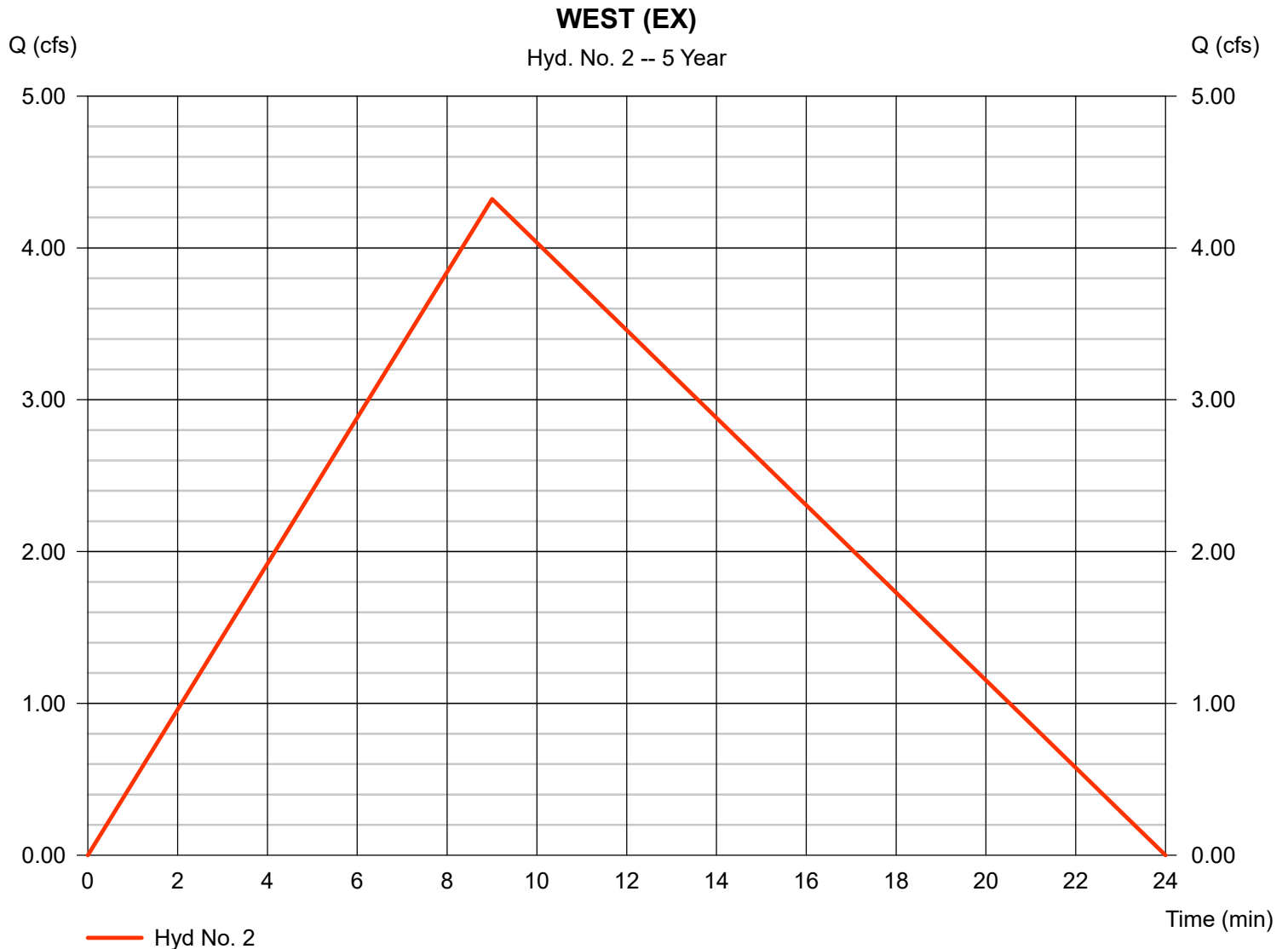

# Hydrograph Report

Hydraflow Hydrographs by Intelisolve v9.1

Friday, Dec 17, 2021

## Hyd. No. 3

EAST UNDET. (PRO.)

Hydrograph type = Rational  
Storm frequency = 5 yrs  
Time interval = 1 min  
Drainage area = 2.720 ac  
Intensity = 5.466 in/hr  
IDF Curve = IDF CURVE.IDF

Peak discharge = 4.460 cfs  
Time to peak = 7 min  
Hyd. volume = 2,498 cuft  
Runoff coeff. = 0.3  
Tc by TR55 = 7.00 min  
Asc/Rec limb fact = 1/1.66667

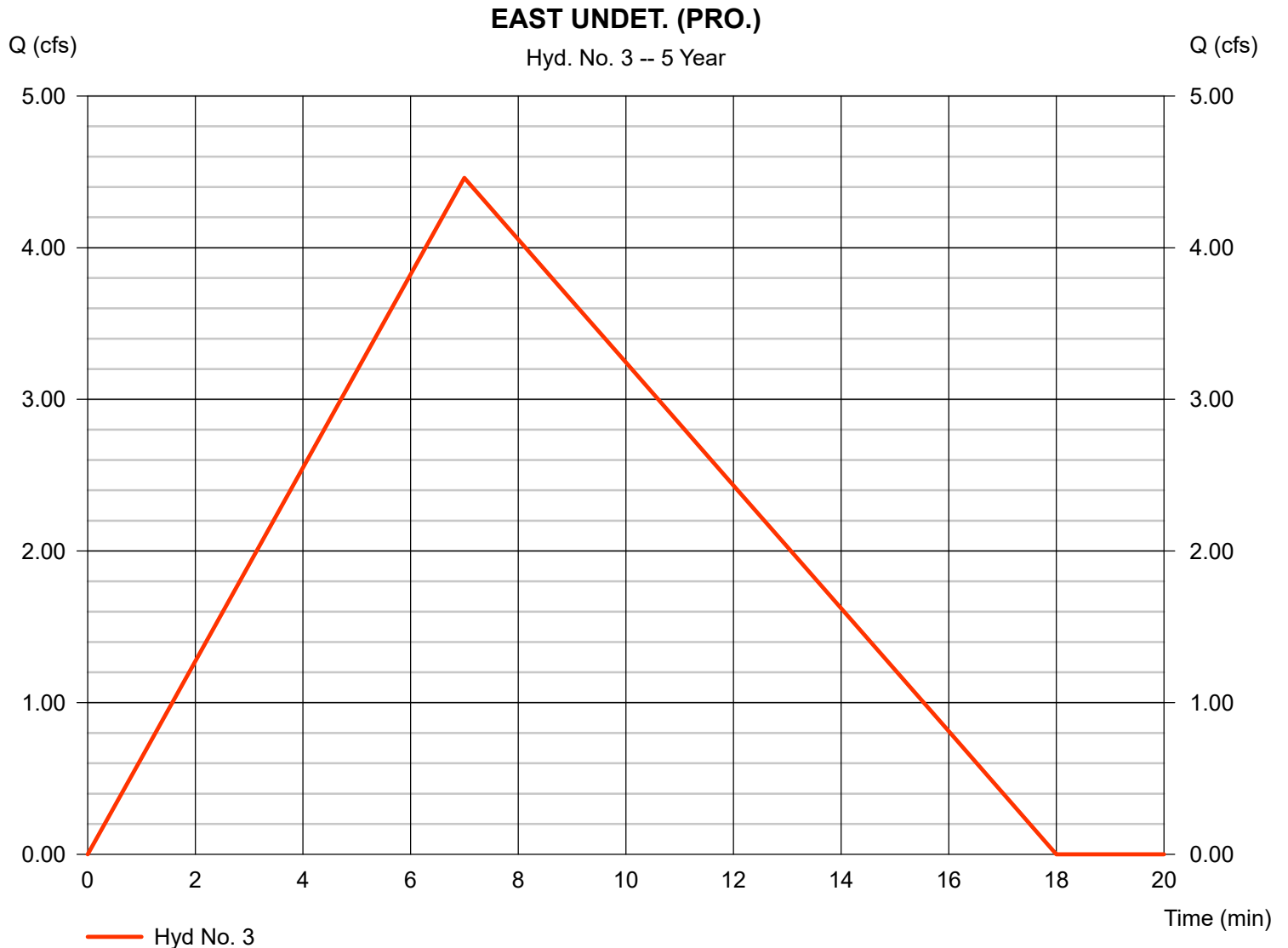

# Hydrograph Report

Hydraflow Hydrographs by Intelisolve v9.1

Friday, Dec 17, 2021

## Hyd. No. 4

EAST DET.1 (PRO.)

Hydrograph type = Rational  
Storm frequency = 5 yrs  
Time interval = 1 min  
Drainage area = 1.320 ac  
Intensity = 6.340 in/hr  
IDF Curve = IDF CURVE.IDF

Peak discharge = 4.185 cfs  
Time to peak = 5 min  
Hyd. volume = 1,674 cuft  
Runoff coeff. = 0.5  
Tc by User = 5.00 min  
Asc/Rec limb fact = 1/1.66667

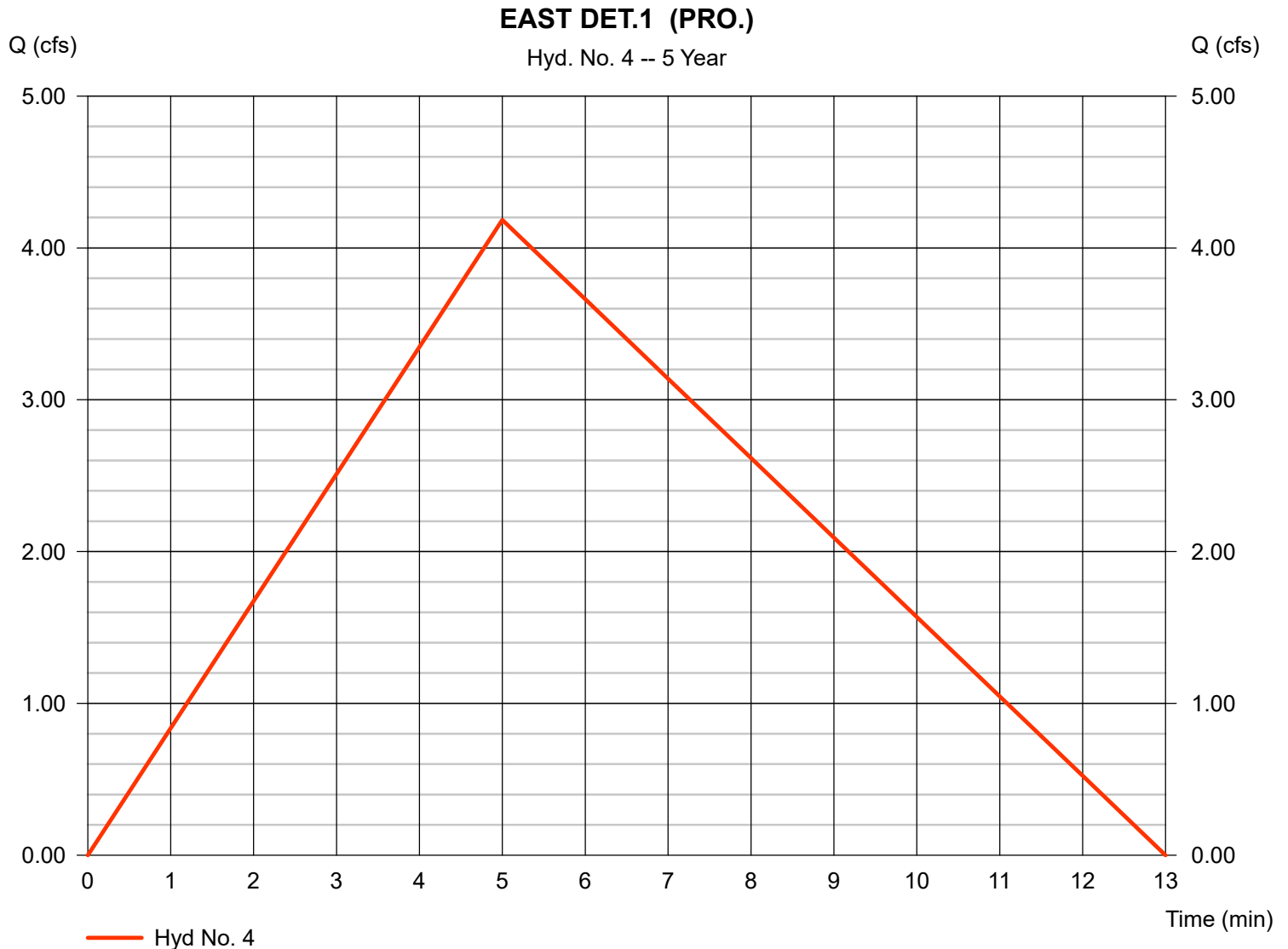

# Hydrograph Report

Hydraflow Hydrographs by Intelisolve v9.1

Friday, Dec 17, 2021

## Hyd. No. 5

EAST DET.2 (PRO.)

Hydrograph type = Rational  
 Storm frequency = 5 yrs  
 Time interval = 1 min  
 Drainage area = 0.900 ac  
 Intensity = 6.340 in/hr  
 IDF Curve = IDF CURVE.IDF

Peak discharge = 4.280 cfs  
 Time to peak = 5 min  
 Hyd. volume = 1,712 cuft  
 Runoff coeff. = 0.75  
 Tc by User = 5.00 min  
 Asc/Rec limb fact = 1/1.66667

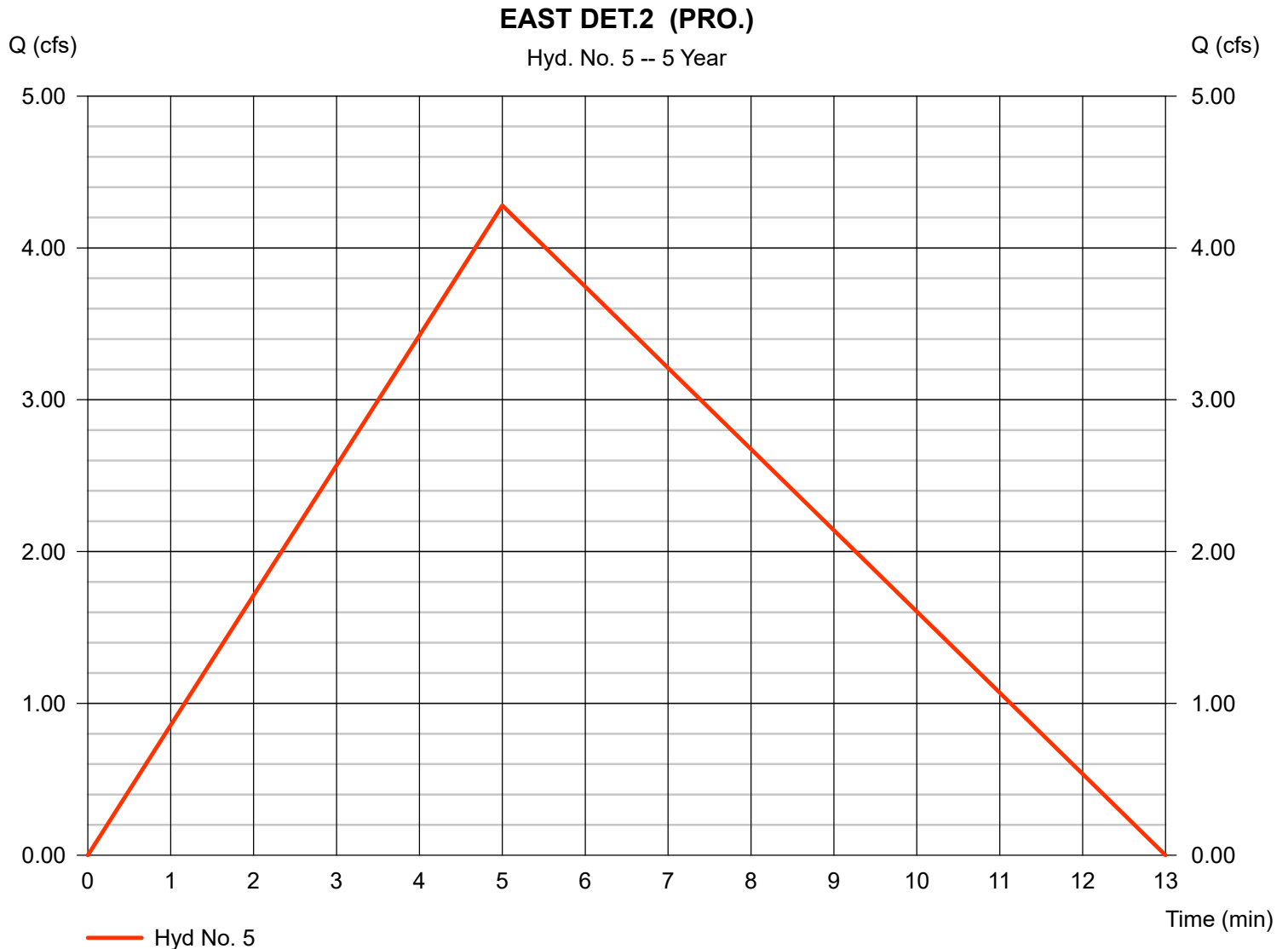



# Hydrograph Report

Hydraflow Hydrographs by Intelisolve v9.1

Friday, Dec 17, 2021

## Hyd. No. 6

Outflow (U.G. Sys. 3)

Hydrograph type	= Reservoir	Peak discharge	= 0.000 cfs
Storm frequency	= 5 yrs	Time to peak	= n/a
Time interval	= 1 min	Hyd. volume	= 0 cuft
Inflow hyd. No.	= 4 - EAST DET.1 (PRO.)	Max. Elevation	= 226.34 ft
Reservoir name	= U.G. STORAGE SYSTEM #3	Max. Storage	= 1,632 cuft

Storage Indication method used.

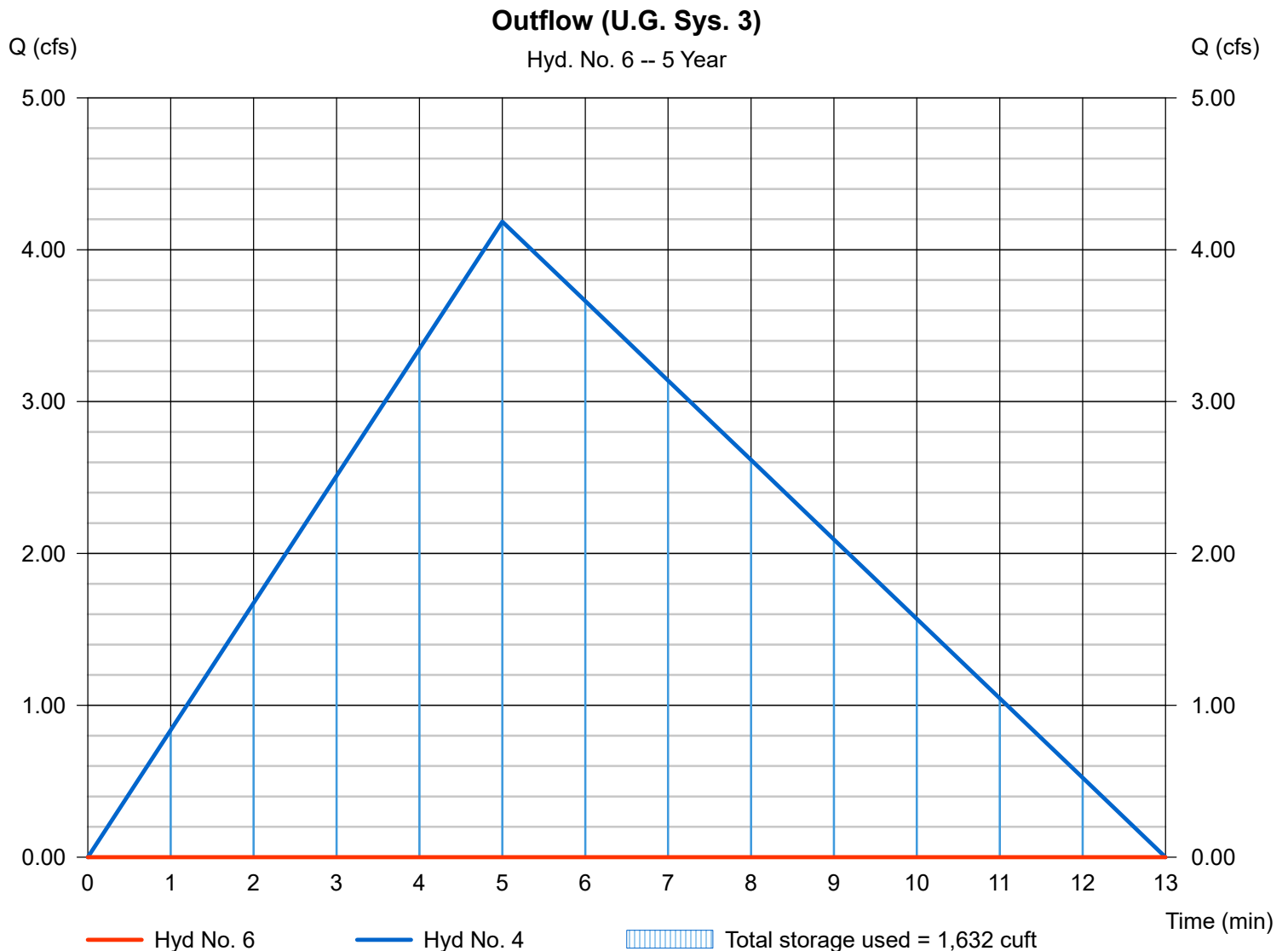

# Hydrograph Report

Hydraflow Hydrographs by Intelisolve v9.1

Friday, Dec 17, 2021

## Hyd. No. 7

Inflow (WQ Basin)

Hydrograph type = Combine  
Storm frequency = 5 yrs  
Time interval = 1 min  
Inflow hyds. = 5, 6

Peak discharge = 4.280 cfs  
Time to peak = 5 min  
Hyd. volume = 1,669 cuft  
Contrib. drain. area = 0.900 ac

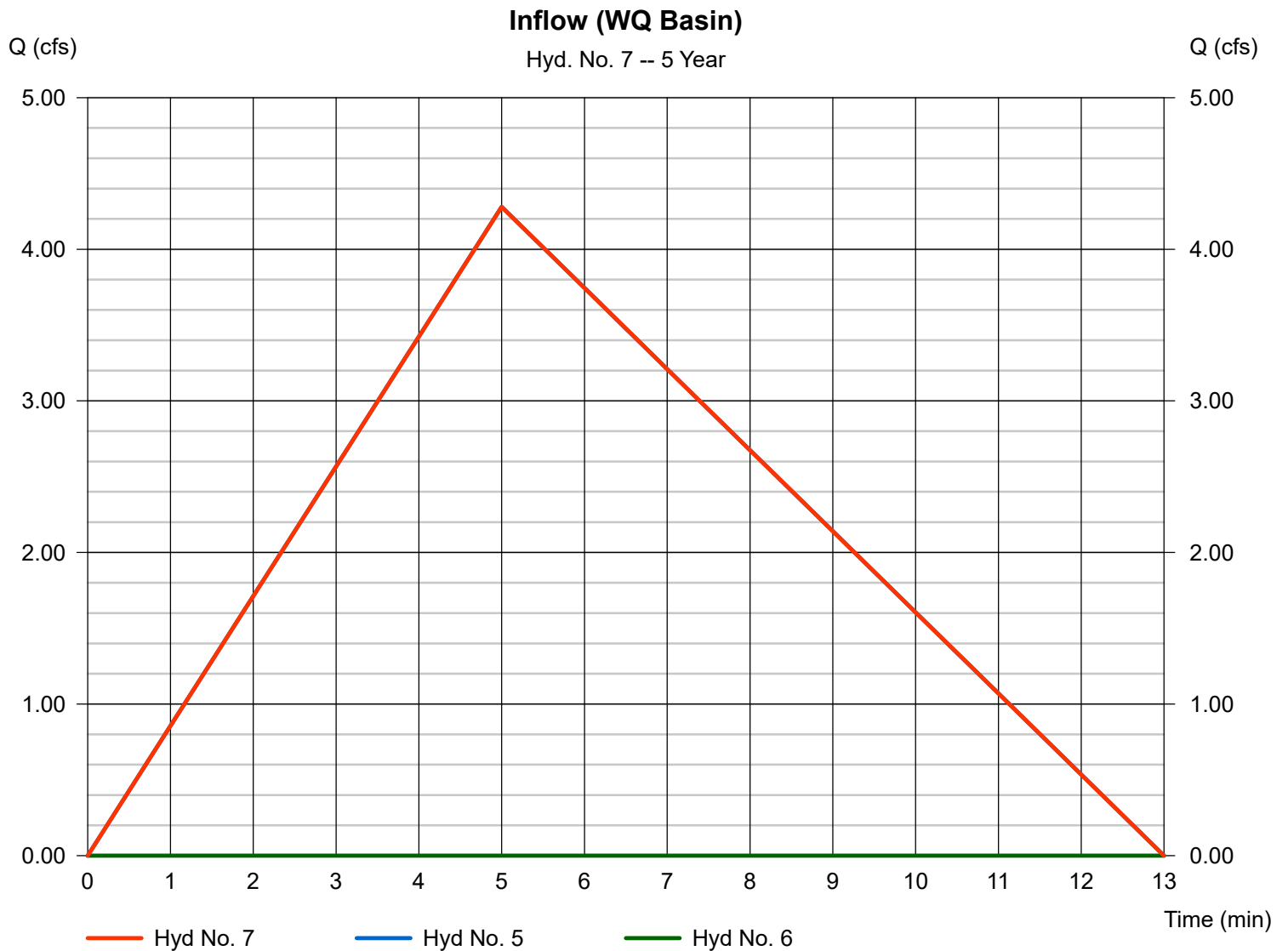

# Hydrograph Report

Hydraflow Hydrographs by Intelisolve v9.1

Friday, Dec 17, 2021

## Hyd. No. 8

Outflow (WQ Basin)

Hydrograph type = Reservoir  
 Storm frequency = 5 yrs  
 Time interval = 1 min  
 Inflow hyd. No. = 7 - Inflow (WQ Basin)  
 Reservoir name = WQ BASIN

Peak discharge = 0.788 cfs  
 Time to peak = 12 min  
 Hyd. volume = 1,115 cuft  
 Max. Elevation = 212.95 ft  
 Max. Storage = 1,403 cuft

Storage Indication method used.

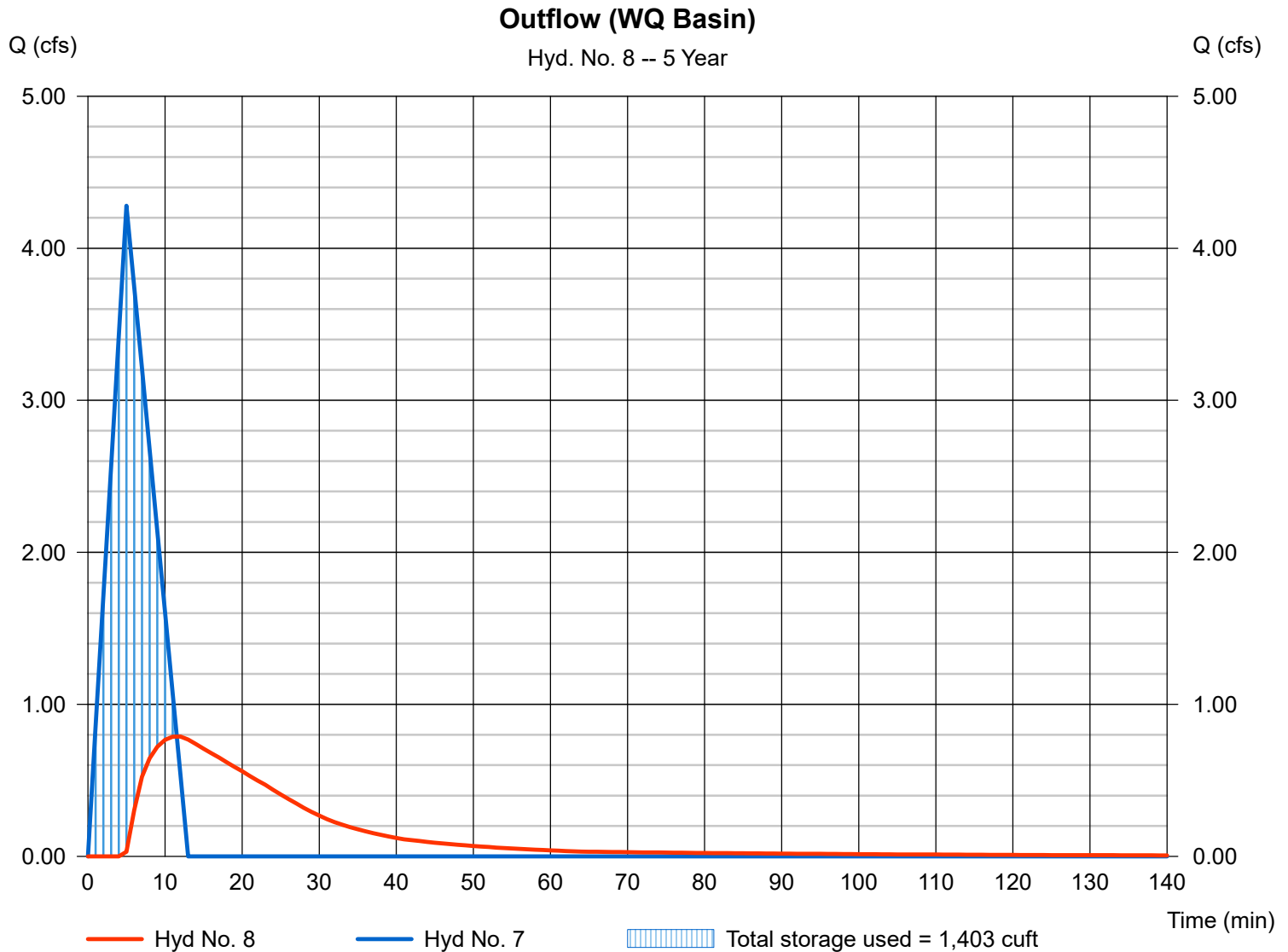

# Hydrograph Report

Hydraflow Hydrographs by Intelisolve v9.1

Friday, Dec 17, 2021

## Hyd. No. 9

TOTAL EAST (PRO)

Hydrograph type = Combine  
Storm frequency = 5 yrs  
Time interval = 1 min  
Inflow hyds. = 3, 8

Peak discharge = 4.985 cfs  
Time to peak = 7 min  
Hyd. volume = 3,524 cuft  
Contrib. drain. area = 2.720 ac

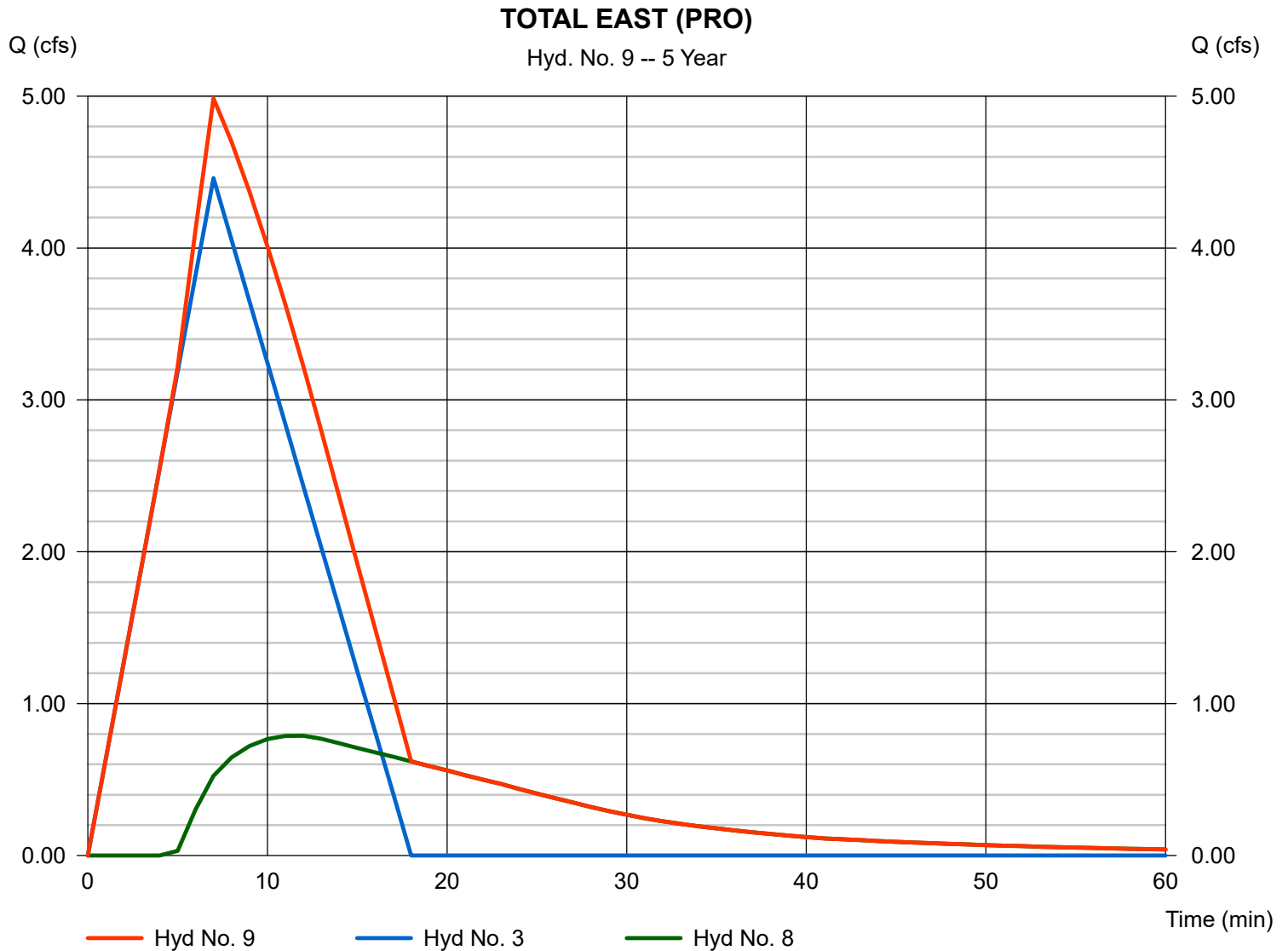

# Hydrograph Report

Hydraflow Hydrographs by Intelisolve v9.1

Friday, Dec 17, 2021

## Hyd. No. 10

WEST UNDET. (PRO.)

Hydrograph type = Rational  
 Storm frequency = 5 yrs  
 Time interval = 1 min  
 Drainage area = 1.710 ac  
 Intensity = 5.466 in/hr  
 IDF Curve = IDF CURVE.IDF

Peak discharge = 3.365 cfs  
 Time to peak = 7 min  
 Hyd. volume = 1,884 cuft  
 Runoff coeff. = 0.36  
 Tc by TR55 = 7.00 min  
 Asc/Rec limb fact = 1/1.66667

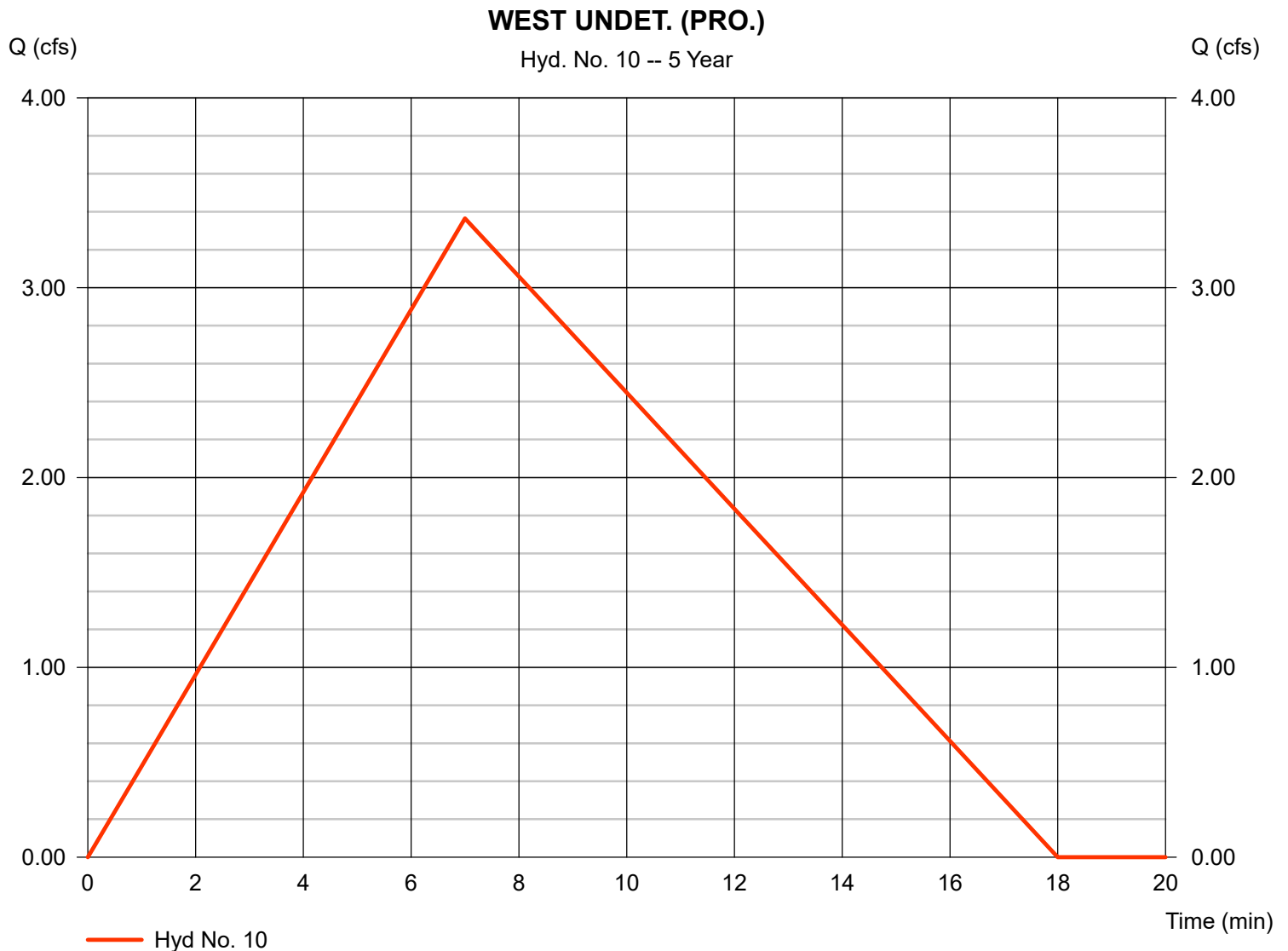

# Hydrograph Report

Hydraflow Hydrographs by Intelisolve v9.1

Friday, Dec 17, 2021

## Hyd. No. 11

WEST DET.1 (PRO.)

Hydrograph type = Rational  
 Storm frequency = 5 yrs  
 Time interval = 1 min  
 Drainage area = 0.386 ac  
 Intensity = 6.340 in/hr  
 IDF Curve = IDF CURVE.IDF

Peak discharge = 2.007 cfs  
 Time to peak = 5 min  
 Hyd. volume = 803 cuft  
 Runoff coeff. = 0.82  
 Tc by User = 5.00 min  
 Asc/Rec limb fact = 1/1.66667

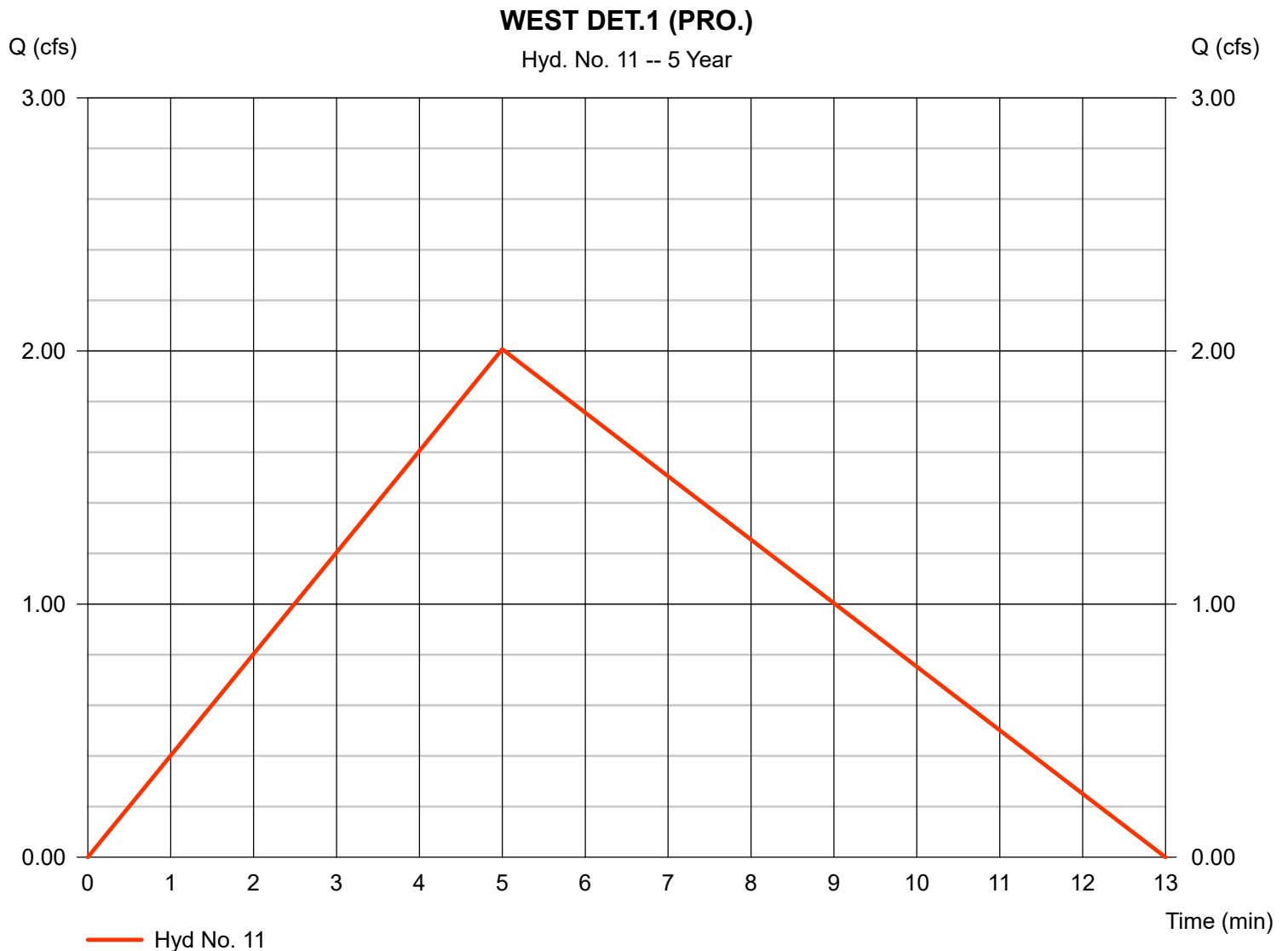

# Hydrograph Report

Hydraflow Hydrographs by Intelisolve v9.1

Friday, Dec 17, 2021

## Hyd. No. 12

WEST DET.2 (PRO.)

Hydrograph type = Rational  
Storm frequency = 5 yrs  
Time interval = 1 min  
Drainage area = 0.702 ac  
Intensity = 6.340 in/hr  
IDF Curve = IDF CURVE.IDF

Peak discharge = 3.650 cfs  
Time to peak = 5 min  
Hyd. volume = 1,460 cuft  
Runoff coeff. = 0.82  
Tc by User = 5.00 min  
Asc/Rec limb fact = 1/1.66667

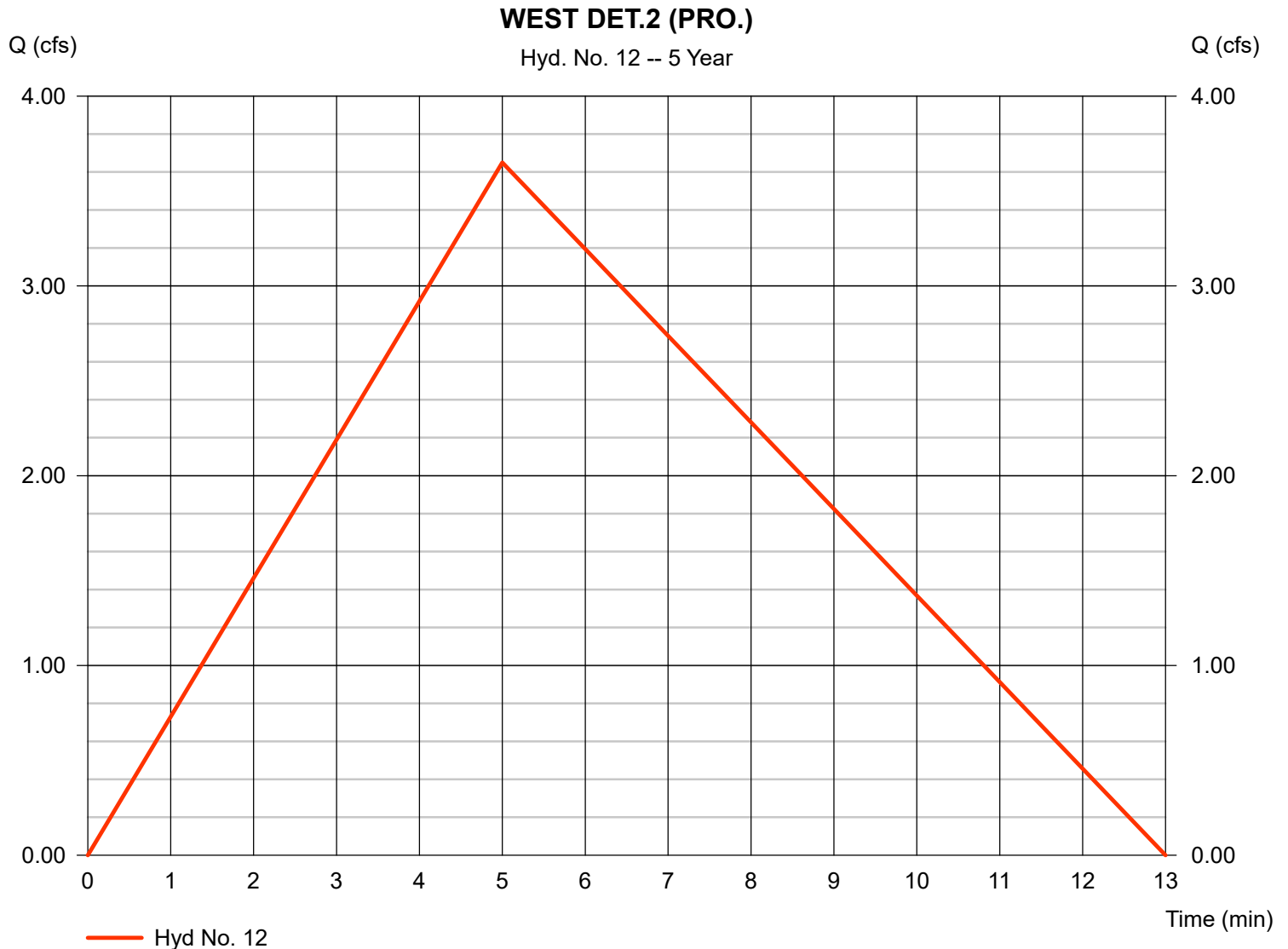

# Hydrograph Report

Hydraflow Hydrographs by Intelisolve v9.1

Friday, Dec 17, 2021

## Hyd. No. 13

Outflow (U.G. Sys. 1)

Hydrograph type	= Reservoir	Peak discharge	= 0.000 cfs
Storm frequency	= 5 yrs	Time to peak	= n/a
Time interval	= 1 min	Hyd. volume	= 0 cuft
Inflow hyd. No.	= 11 - WEST DET.1 (PRO.)	Max. Elevation	= 236.32 ft
Reservoir name	= U.G. STORAGE SYSTEM #1	Max. Storage	= 783 cuft

Storage Indication method used.

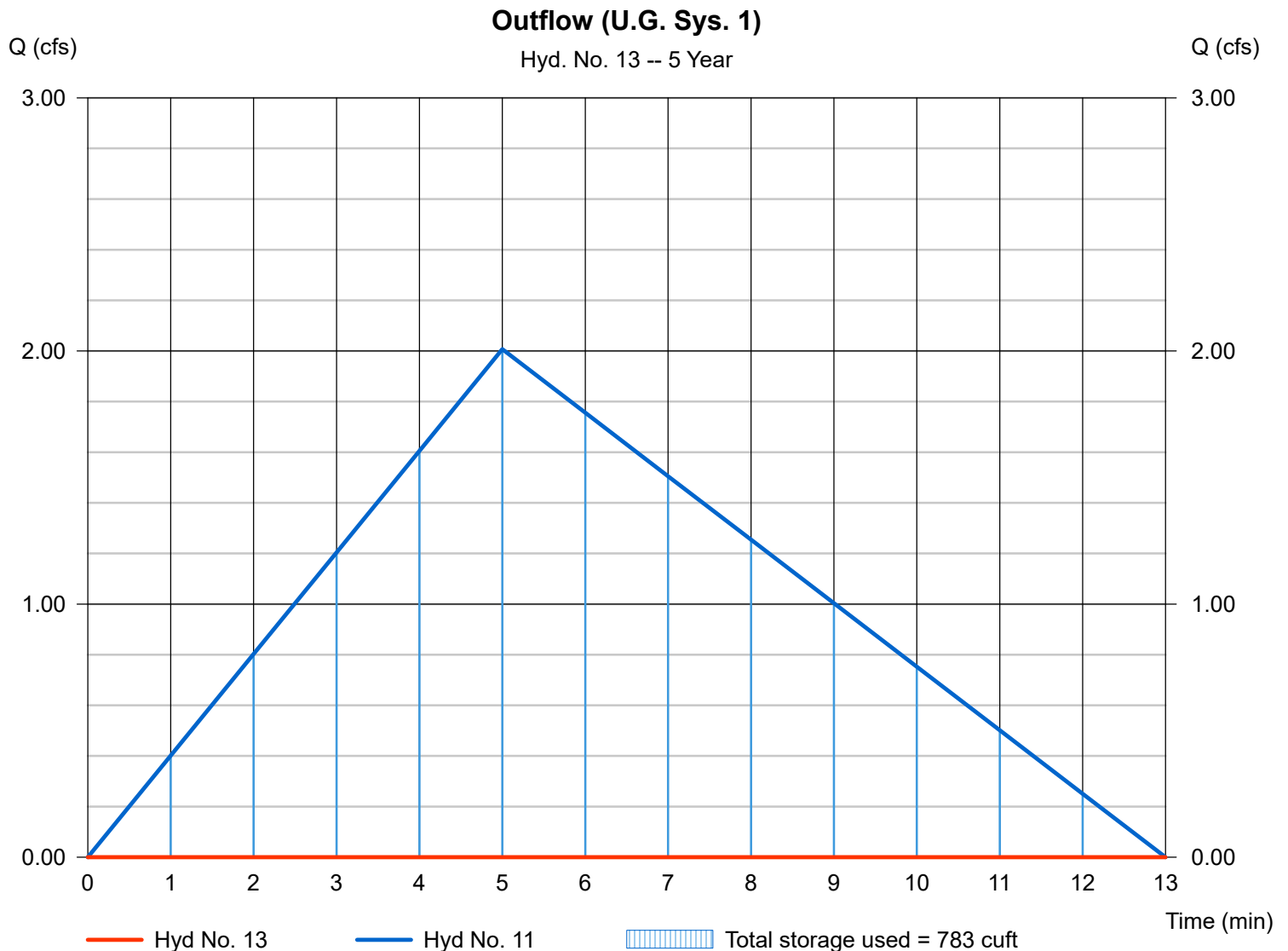



# Hydrograph Report

Hydraflow Hydrographs by Intelisolve v9.1

Friday, Dec 17, 2021

## Hyd. No. 14

Inflow (U.G. Sys. 2)

Hydrograph type = Combine  
Storm frequency = 5 yrs  
Time interval = 1 min  
Inflow hyds. = 12, 13

Peak discharge = 3.650 cfs  
Time to peak = 5 min  
Hyd. volume = 1,423 cuft  
Contrib. drain. area = 0.702 ac

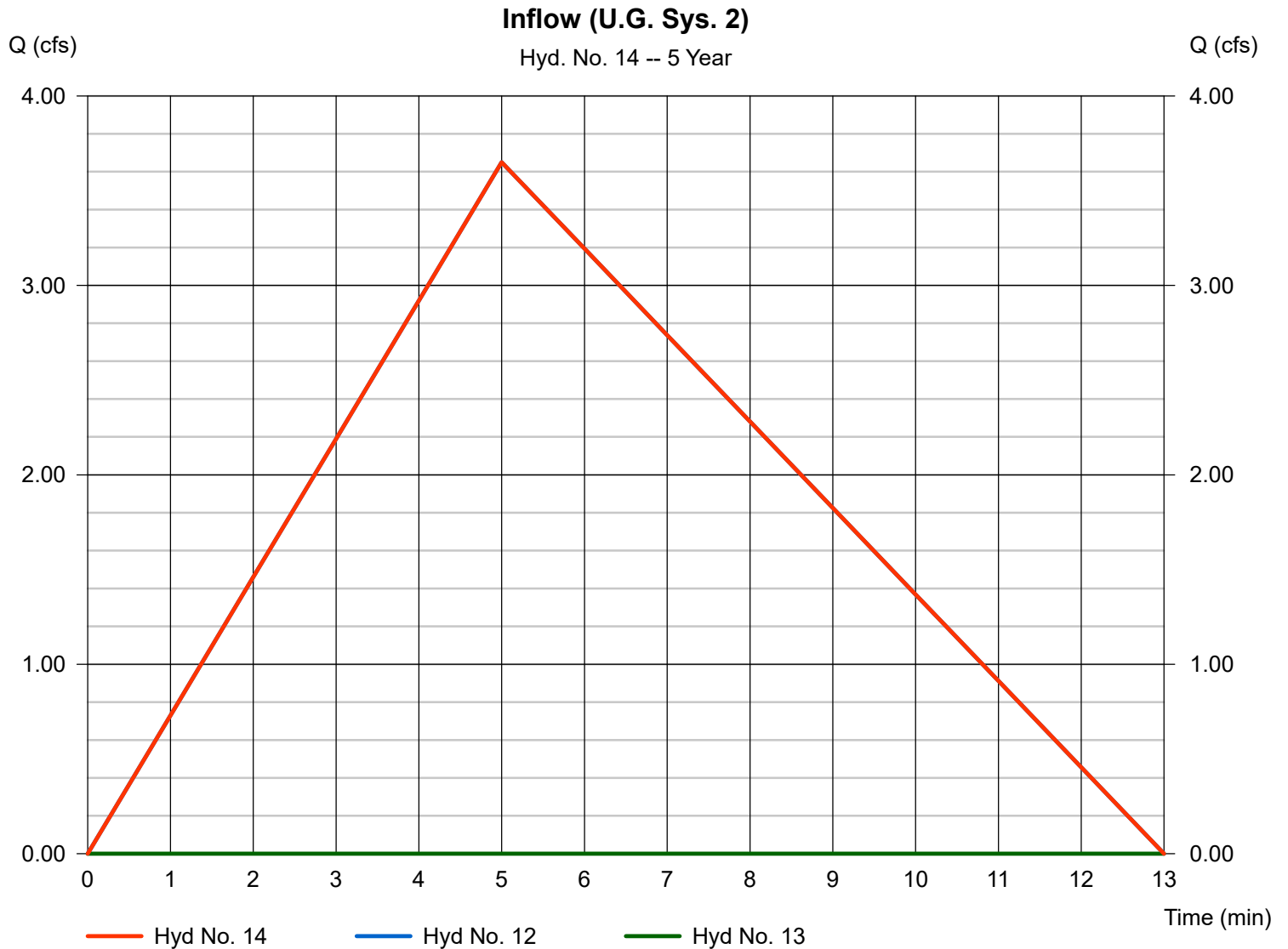

# Hydrograph Report

Hydraflow Hydrographs by Intelisolve v9.1

Friday, Dec 17, 2021

## Hyd. No. 15

Outflow (U.G. Sys. 2)

Hydrograph type	= Reservoir	Peak discharge	= 0.939 cfs
Storm frequency	= 5 yrs	Time to peak	= 11 min
Time interval	= 1 min	Hyd. volume	= 1,421 cuft
Inflow hyd. No.	= 14 - Inflow (U.G. Sys. 2)	Max. Elevation	= 230.91 ft
Reservoir name	= U.G. STORAGE SYSTEM #2	Max. Storage	= 981 cuft

Storage Indication method used.

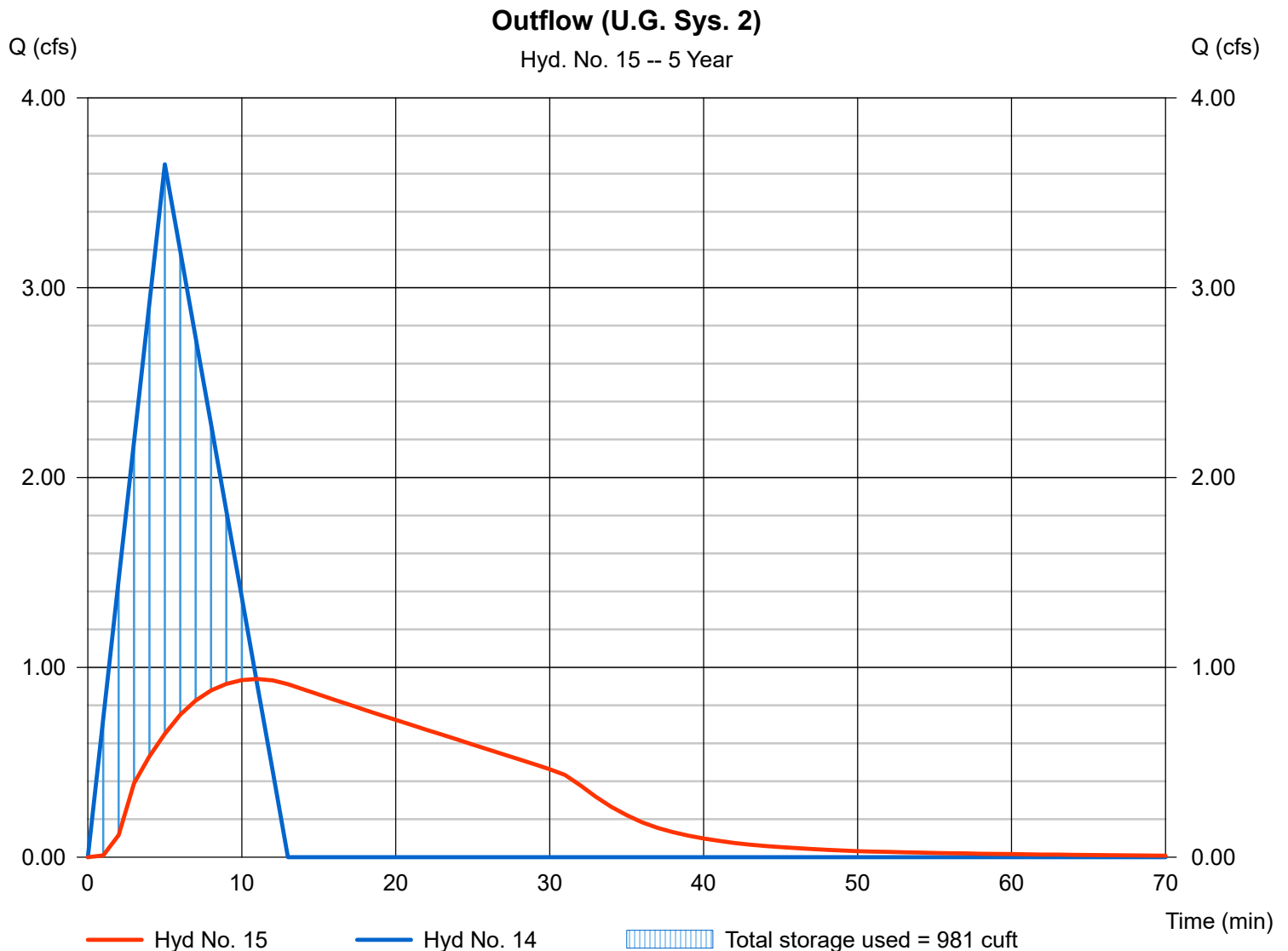

# Hydrograph Report

Hydraflow Hydrographs by Intelisolve v9.1

Friday, Dec 17, 2021

## Hyd. No. 16

TOTAL WEST (PRO)

Hydrograph type = Combine  
Storm frequency = 5 yrs  
Time interval = 1 min  
Inflow hyds. = 10, 15

Peak discharge = 4.190 cfs  
Time to peak = 7 min  
Hyd. volume = 3,238 cuft  
Contrib. drain. area = 1.710 ac

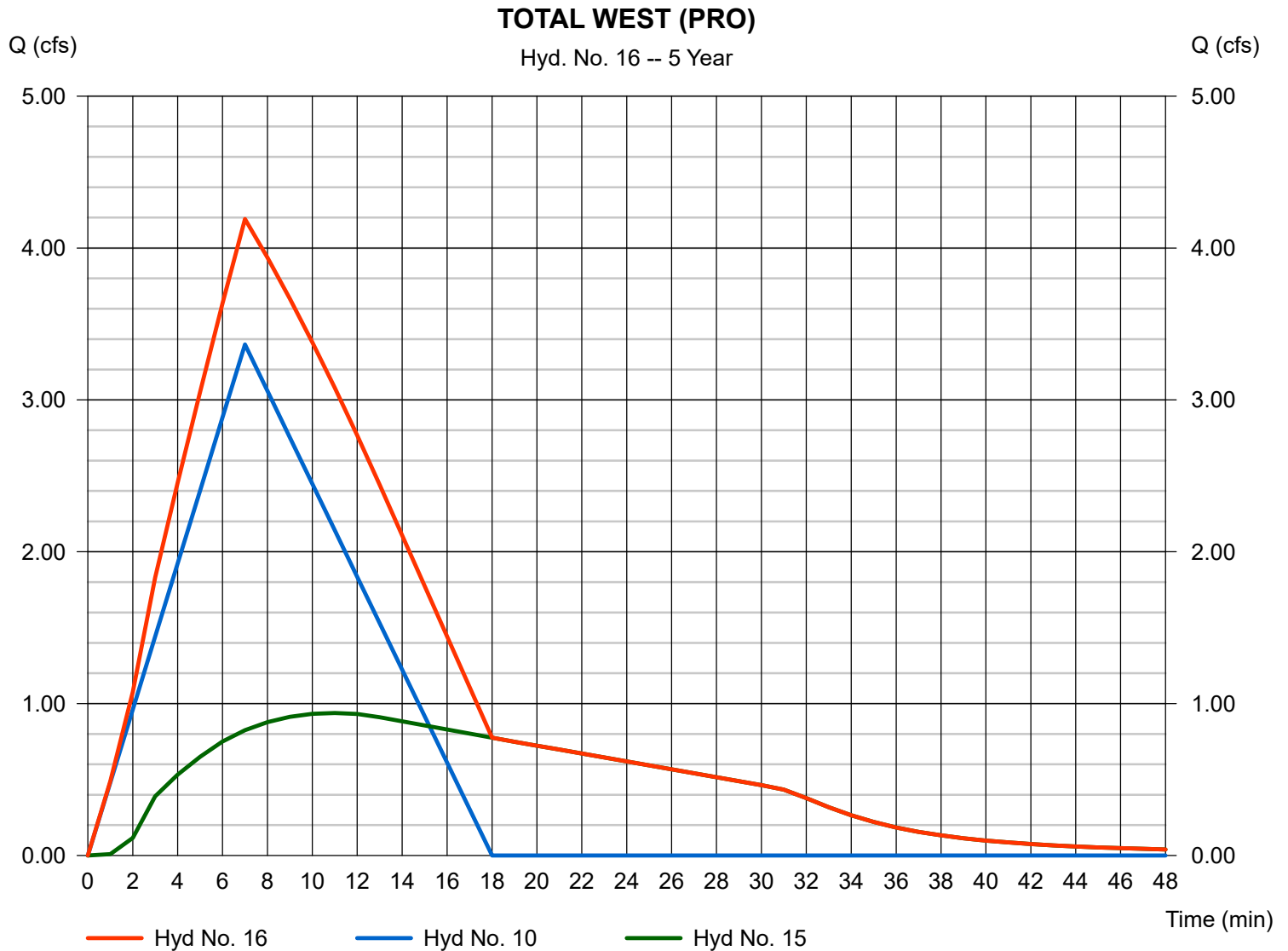

# Hydrograph Summary Report

Hydraflow Hydrographs by Intelisolve v9.1

Hyd. No.	Hydrograph type (origin)	Peak flow (cfs)	Time interval (min)	Time to peak (min)	Hyd. volume (cuft)	Inflow hyd(s)	Maximum elevation (ft)	Total strge used (cuft)	Hydrograph description	
1	Rational	10.61	1	7	6,215	---	-----	-----	EAST (EX.)	
2	Rational	5.087	1	9	3,662	---	-----	-----	WEST (EX)	
3	Rational	5.243	1	7	2,936	---	-----	-----	EAST UNDET. (PRO.)	
4	Rational	4.909	1	5	1,964	---	-----	-----	EAST DET.1 (PRO.)	
5	Rational	5.021	1	5	2,008	---	-----	-----	EAST DET.2 (PRO.)	
6	Reservoir	0.000	1	n/a	0	4	226.66	1,915	Outflow (U.G. Sys. 3)	
7	Combine	5.021	1	5	1,958	5, 6	-----	-----	Inflow (WQ Basin)	
8	Reservoir	0.890	1	12	1,404	7	213.14	1,633	Outflow (WQ Basin)	
9	Combine	5.908	1	7	4,235	3, 8	-----	-----	TOTAL EAST (PRO)	
10	Rational	3.955	1	7	2,215	---	-----	-----	WEST UNDET. (PRO.)	
11	Rational	2.354	1	5	942	---	-----	-----	WEST DET.1 (PRO.)	
12	Rational	4.282	1	5	1,713	---	-----	-----	WEST DET.2 (PRO.)	
13	Reservoir	0.000	1	n/a	0	11	236.62	918	Outflow (U.G. Sys. 1)	
14	Combine	4.282	1	5	1,670	12, 13	-----	-----	Inflow (U.G. Sys. 2)	
15	Reservoir	1.034	1	11	1,667	14	231.16	1,179	Outflow (U.G. Sys. 2)	
16	Combine	4.855	1	7	3,803	10, 15	-----	-----	TOTAL WEST (PRO)	
TAPESTRY-2021-12-17.gpw					Return Period: 10 Year			Friday, Dec 17, 2021		

# Hydrograph Report

Hydraflow Hydrographs by Intelisolve v9.1

Friday, Dec 17, 2021

## Hyd. No. 1

EAST (EX.)

Hydrograph type = Rational  
Storm frequency = 10 yrs  
Time interval = 1 min  
Drainage area = 5.110 ac  
Intensity = 6.290 in/hr  
IDF Curve = IDF CURVE.IDF

Peak discharge = 10.61 cfs  
Time to peak = 7 min  
Hyd. volume = 6,215 cuft  
Runoff coeff. = 0.33  
Tc by TR55 = 7.32 min  
Asc/Rec limb fact = 1/1.66667

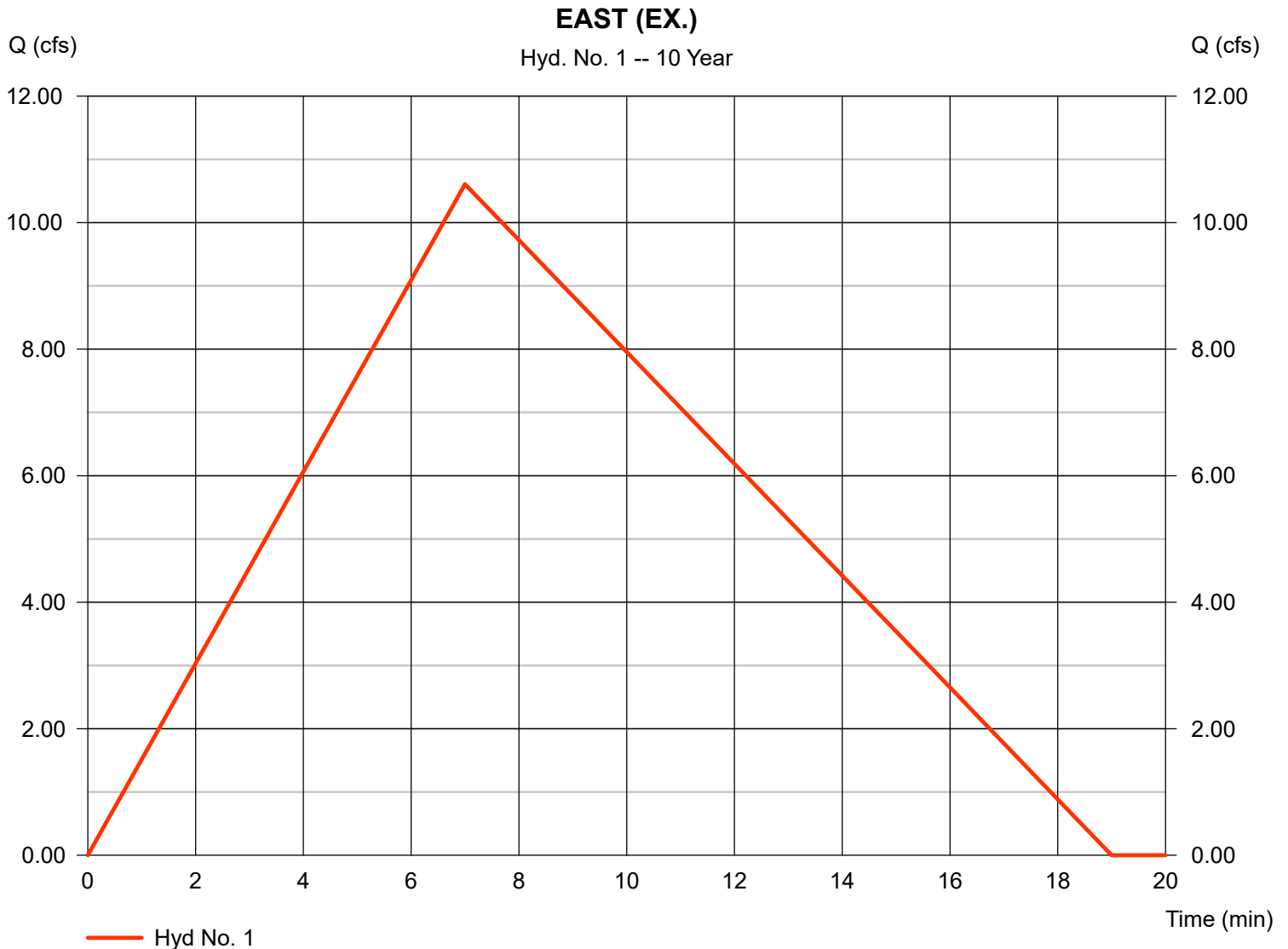

# Hydrograph Report

Hydraflow Hydrographs by Intelisolve v9.1

Friday, Dec 17, 2021

## Hyd. No. 2

WEST (EX)

Hydrograph type = Rational  
Storm frequency = 10 yrs  
Time interval = 1 min  
Drainage area = 2.630 ac  
Intensity = 5.688 in/hr  
IDF Curve = IDF CURVE.IDF

Peak discharge = 5.087 cfs  
Time to peak = 9 min  
Hyd. volume = 3,662 cuft  
Runoff coeff. = 0.34  
Tc by TR55 = 9.00 min  
Asc/Rec limb fact = 1/1.66667

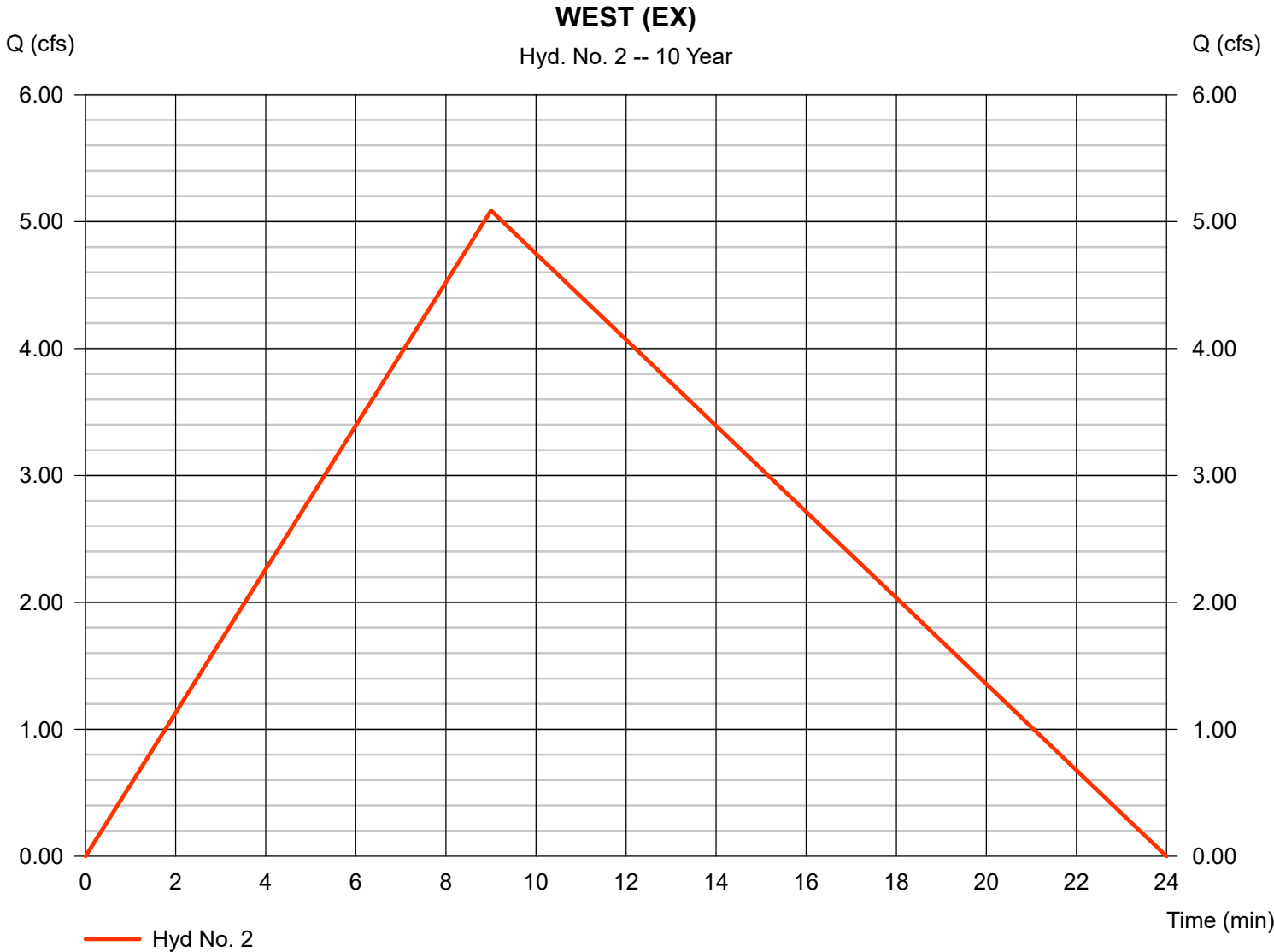

# Hydrograph Report

Hydraflow Hydrographs by Intelisolve v9.1

Friday, Dec 17, 2021

## Hyd. No. 3

EAST UNDET. (PRO.)

Hydrograph type = Rational  
 Storm frequency = 10 yrs  
 Time interval = 1 min  
 Drainage area = 2.720 ac  
 Intensity = 6.425 in/hr  
 IDF Curve = IDF CURVE.IDF

Peak discharge = 5.243 cfs  
 Time to peak = 7 min  
 Hyd. volume = 2,936 cuft  
 Runoff coeff. = 0.3  
 Tc by TR55 = 7.00 min  
 Asc/Rec limb fact = 1/1.66667

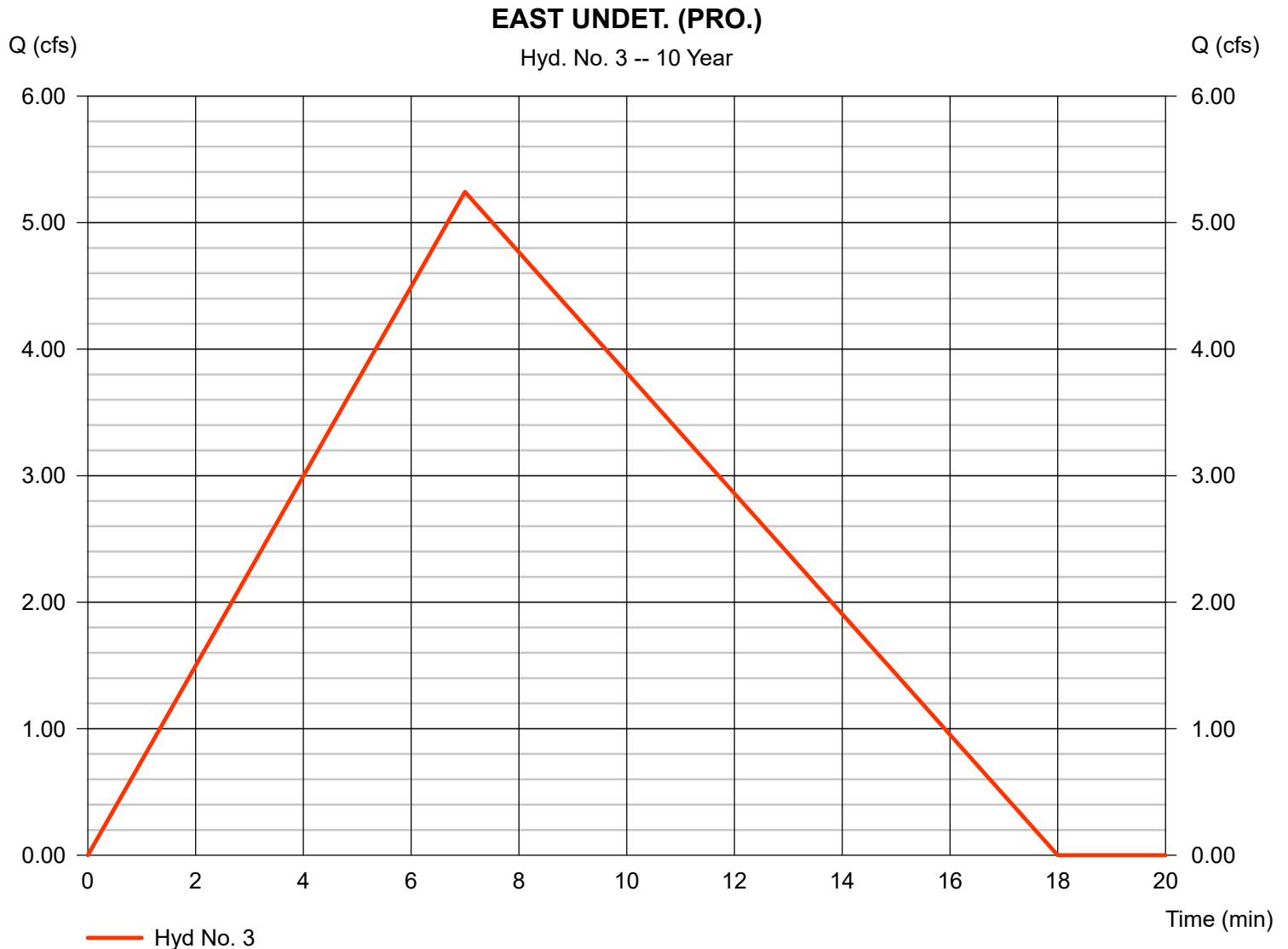

# Hydrograph Report

Hydraflow Hydrographs by Intelisolve v9.1

Friday, Dec 17, 2021

## Hyd. No. 4

EAST DET.1 (PRO.)

Hydrograph type = Rational  
Storm frequency = 10 yrs  
Time interval = 1 min  
Drainage area = 1.320 ac  
Intensity = 7.438 in/hr  
IDF Curve = IDF CURVE.IDF

Peak discharge = 4.909 cfs  
Time to peak = 5 min  
Hyd. volume = 1,964 cuft  
Runoff coeff. = 0.5  
Tc by User = 5.00 min  
Asc/Rec limb fact = 1/1.66667

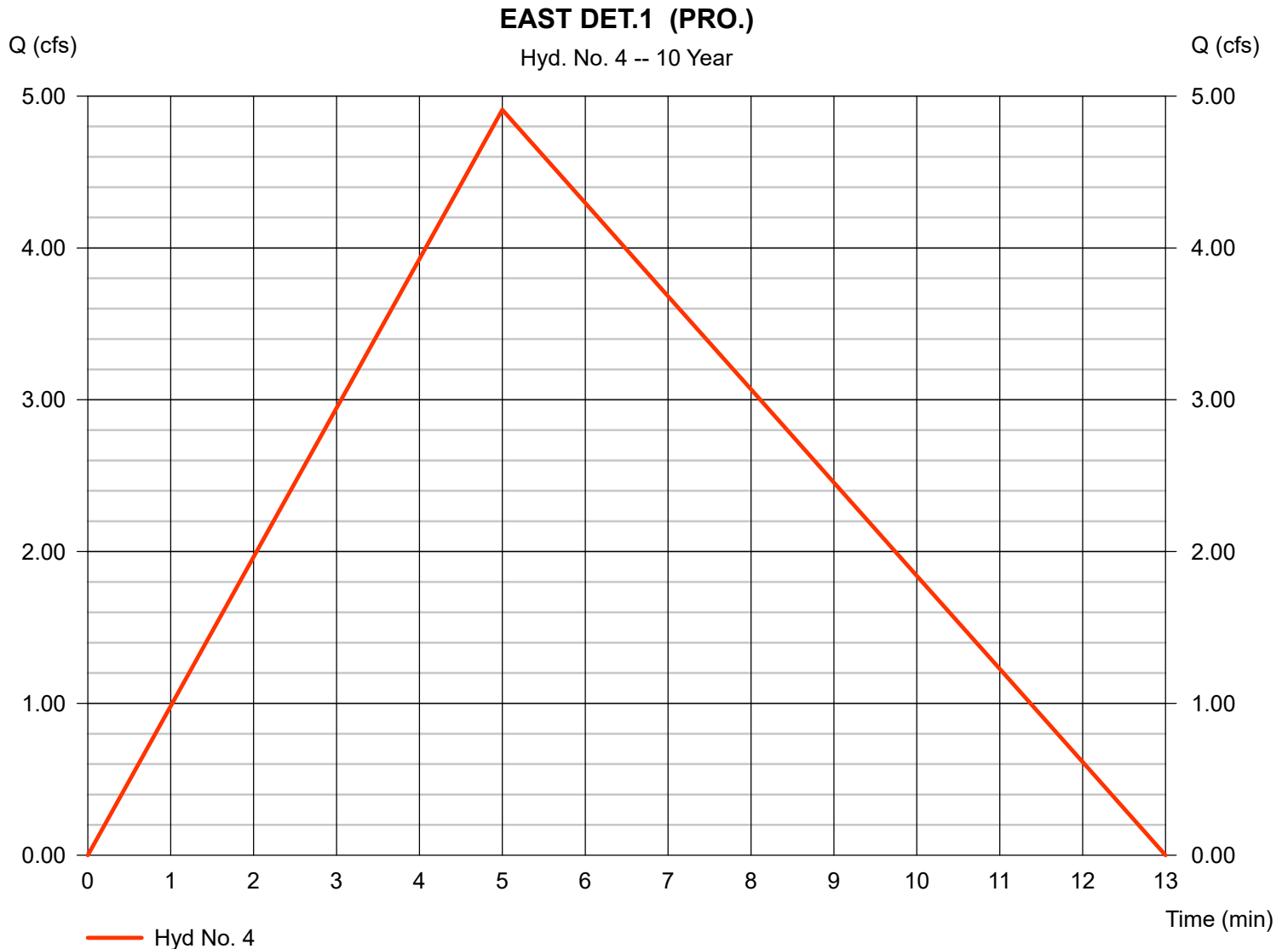



# Hydrograph Report

Hydraflow Hydrographs by Intelisolve v9.1

Friday, Dec 17, 2021

## Hyd. No. 5

EAST DET.2 (PRO.)

Hydrograph type = Rational  
 Storm frequency = 10 yrs  
 Time interval = 1 min  
 Drainage area = 0.900 ac  
 Intensity = 7.438 in/hr  
 IDF Curve = IDF CURVE.IDF

Peak discharge = 5.021 cfs  
 Time to peak = 5 min  
 Hyd. volume = 2,008 cuft  
 Runoff coeff. = 0.75  
 Tc by User = 5.00 min  
 Asc/Rec limb fact = 1/1.66667

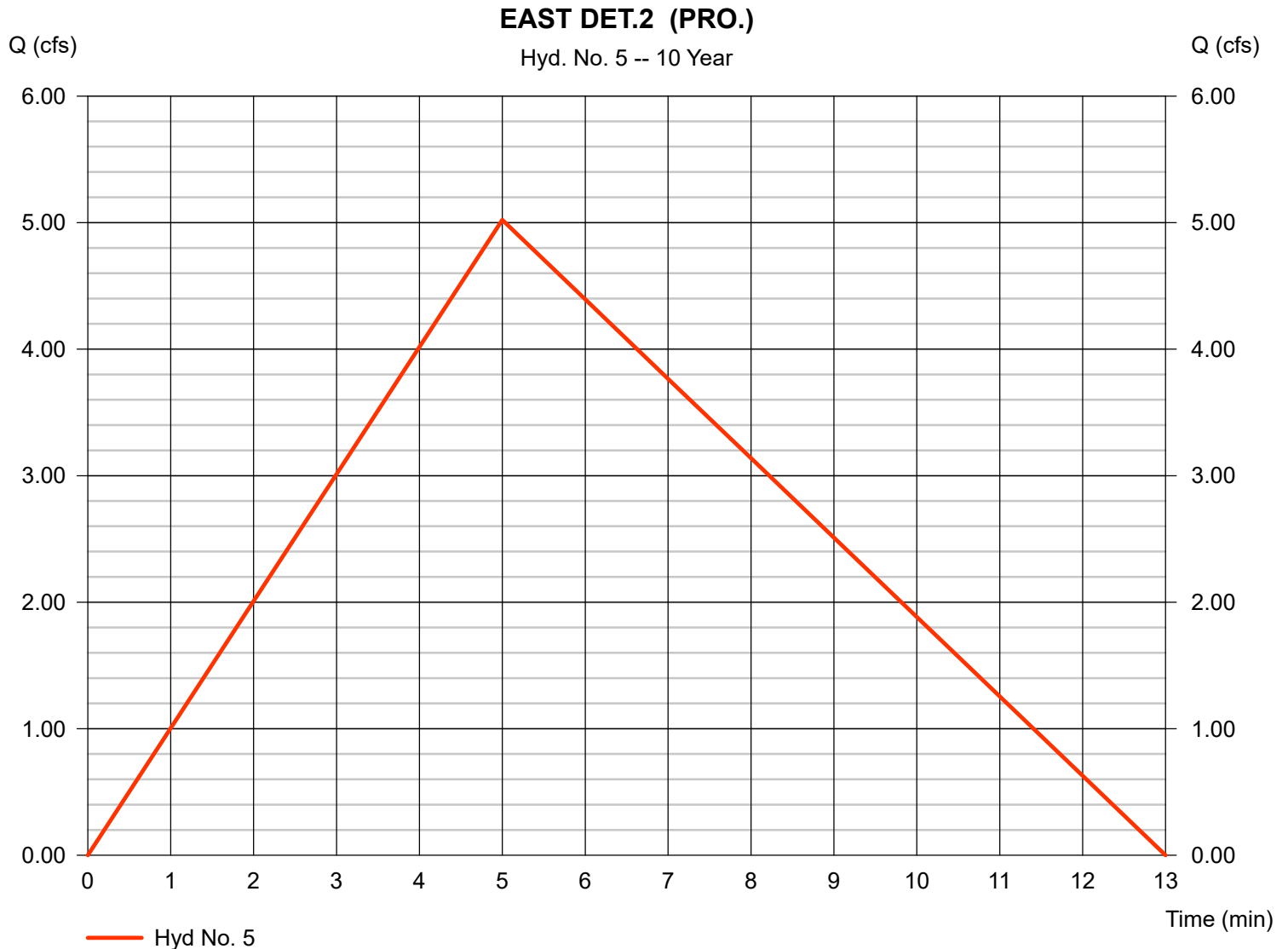

# Hydrograph Report

Hydraflow Hydrographs by Intelisolve v9.1

Friday, Dec 17, 2021

## Hyd. No. 6

Outflow (U.G. Sys. 3)

Hydrograph type	= Reservoir	Peak discharge	= 0.000 cfs
Storm frequency	= 10 yrs	Time to peak	= n/a
Time interval	= 1 min	Hyd. volume	= 0 cuft
Inflow hyd. No.	= 4 - EAST DET.1 (PRO.)	Max. Elevation	= 226.66 ft
Reservoir name	= U.G. STORAGE SYSTEM #3	Max. Storage	= 1,915 cuft

Storage Indication method used.

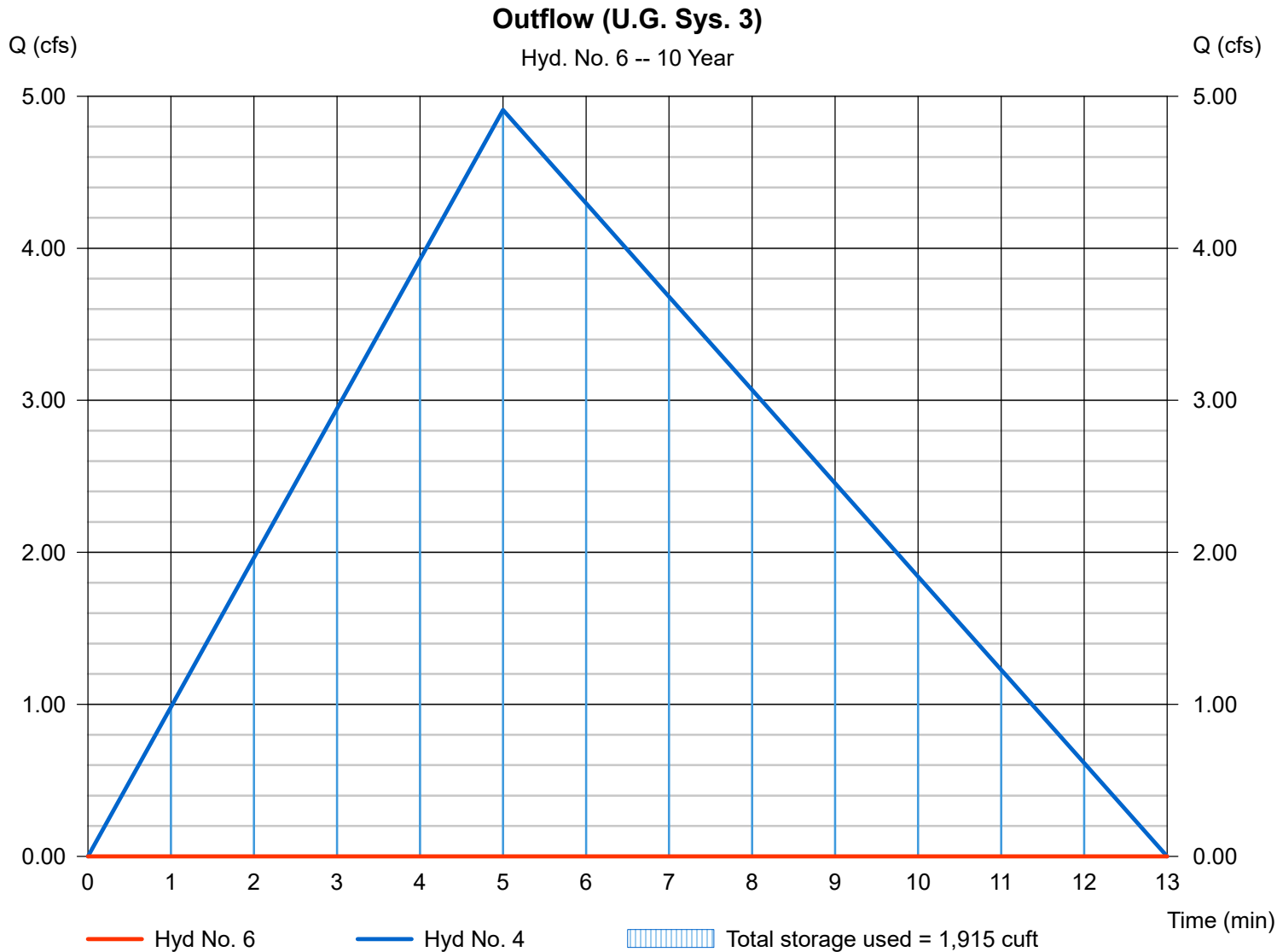

# Hydrograph Report

Hydraflow Hydrographs by Intelisolve v9.1

Friday, Dec 17, 2021

## Hyd. No. 7

Inflow (WQ Basin)

Hydrograph type = Combine  
Storm frequency = 10 yrs  
Time interval = 1 min  
Inflow hyds. = 5, 6

Peak discharge = 5.021 cfs  
Time to peak = 5 min  
Hyd. volume = 1,958 cuft  
Contrib. drain. area = 0.900 ac

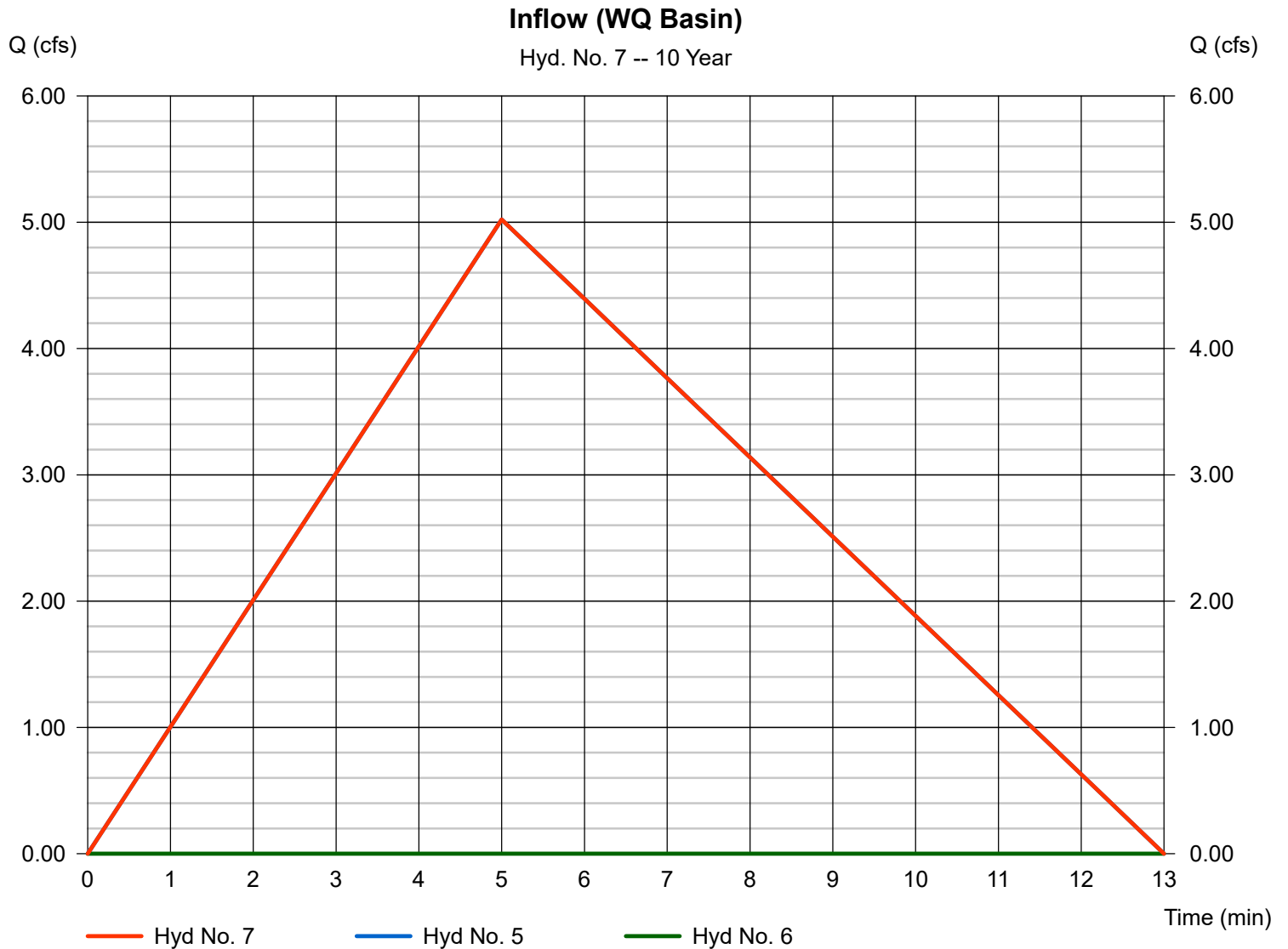

# Hydrograph Report

Hydraflow Hydrographs by Intelisolve v9.1

Friday, Dec 17, 2021

## Hyd. No. 8

Outflow (WQ Basin)

Hydrograph type = Reservoir  
Storm frequency = 10 yrs  
Time interval = 1 min  
Inflow hyd. No. = 7 - Inflow (WQ Basin)  
Reservoir name = WQ BASIN

Peak discharge = 0.890 cfs  
Time to peak = 12 min  
Hyd. volume = 1,404 cuft  
Max. Elevation = 213.14 ft  
Max. Storage = 1,633 cuft

Storage Indication method used.

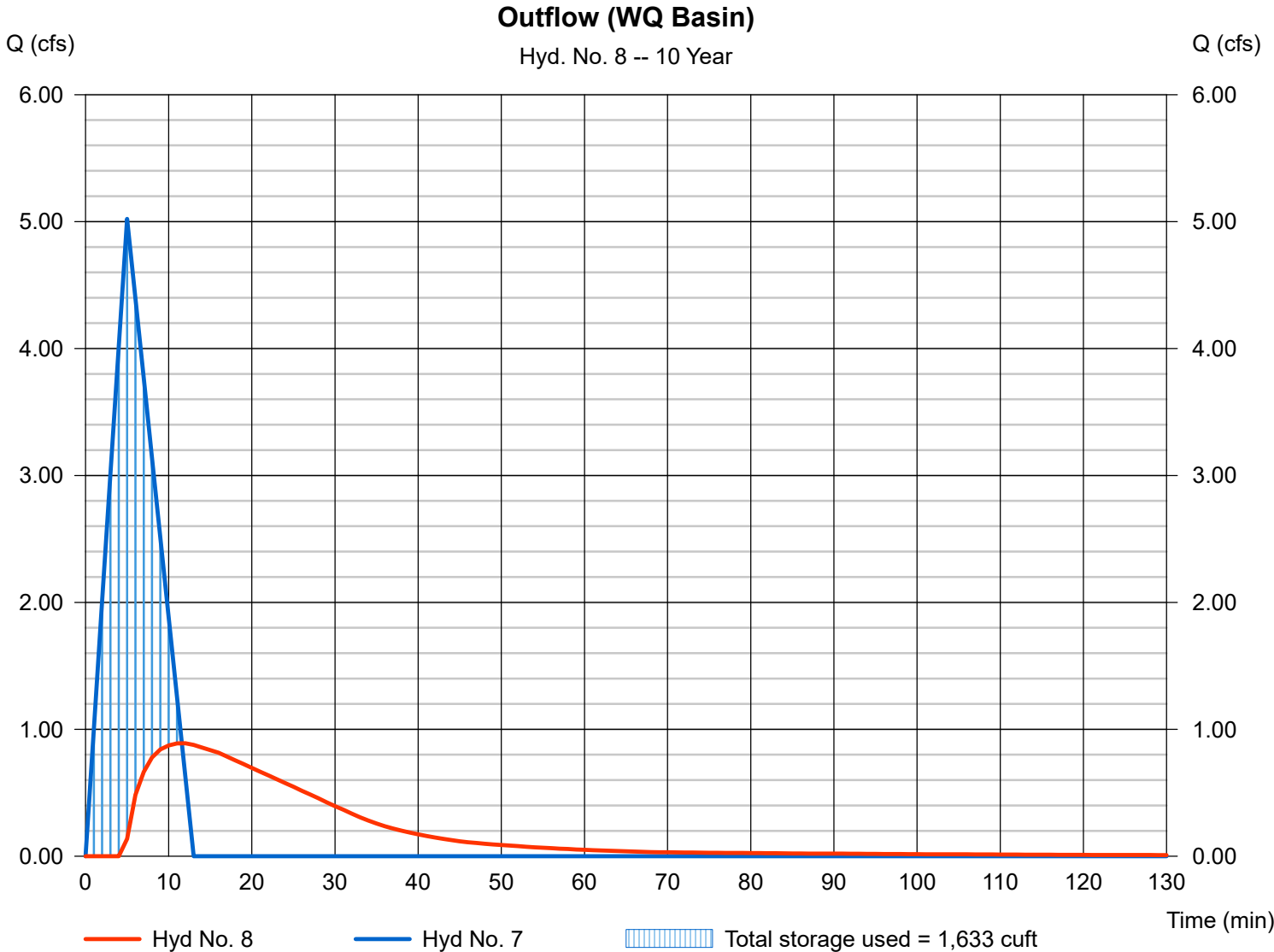

# Hydrograph Report

Hydraflow Hydrographs by Intelisolve v9.1

Friday, Dec 17, 2021

## Hyd. No. 9

TOTAL EAST (PRO)

Hydrograph type = Combine  
 Storm frequency = 10 yrs  
 Time interval = 1 min  
 Inflow hyds. = 3, 8

Peak discharge = 5.908 cfs  
 Time to peak = 7 min  
 Hyd. volume = 4,235 cuft  
 Contrib. drain. area = 2.720 ac

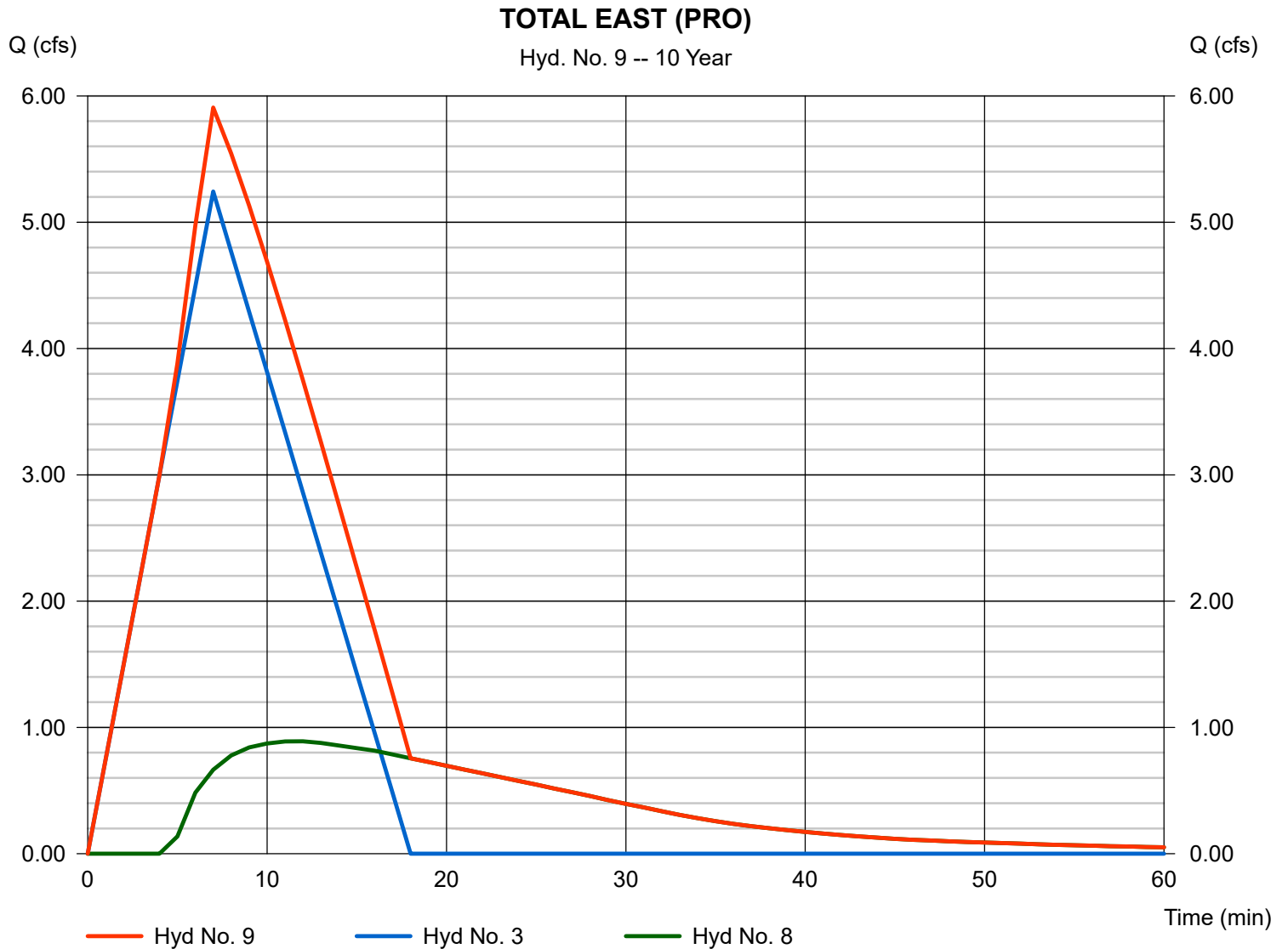

# Hydrograph Report

Hydraflow Hydrographs by Intelisolve v9.1

Friday, Dec 17, 2021

## Hyd. No. 10

WEST UNDET. (PRO.)

Hydrograph type = Rational  
 Storm frequency = 10 yrs  
 Time interval = 1 min  
 Drainage area = 1.710 ac  
 Intensity = 6.425 in/hr  
 IDF Curve = IDF CURVE.IDF

Peak discharge = 3.955 cfs  
 Time to peak = 7 min  
 Hyd. volume = 2,215 cuft  
 Runoff coeff. = 0.36  
 Tc by TR55 = 7.00 min  
 Asc/Rec limb fact = 1/1.66667

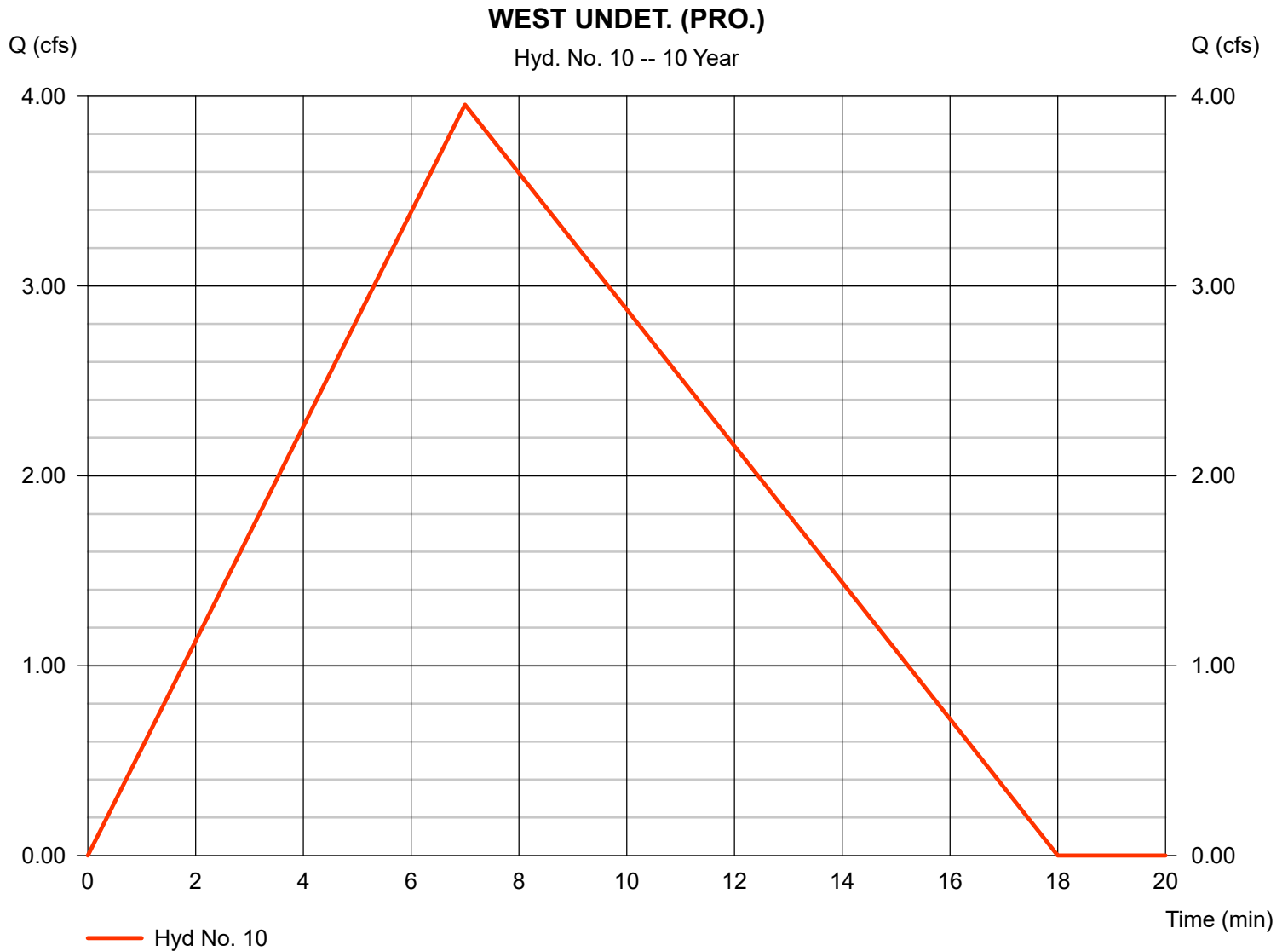

# Hydrograph Report

Hydraflow Hydrographs by Intelisolve v9.1

Friday, Dec 17, 2021

## Hyd. No. 11

WEST DET.1 (PRO.)

Hydrograph type = Rational  
 Storm frequency = 10 yrs  
 Time interval = 1 min  
 Drainage area = 0.386 ac  
 Intensity = 7.438 in/hr  
 IDF Curve = IDF CURVE.IDF

Peak discharge = 2.354 cfs  
 Time to peak = 5 min  
 Hyd. volume = 942 cuft  
 Runoff coeff. = 0.82  
 Tc by User = 5.00 min  
 Asc/Rec limb fact = 1/1.66667

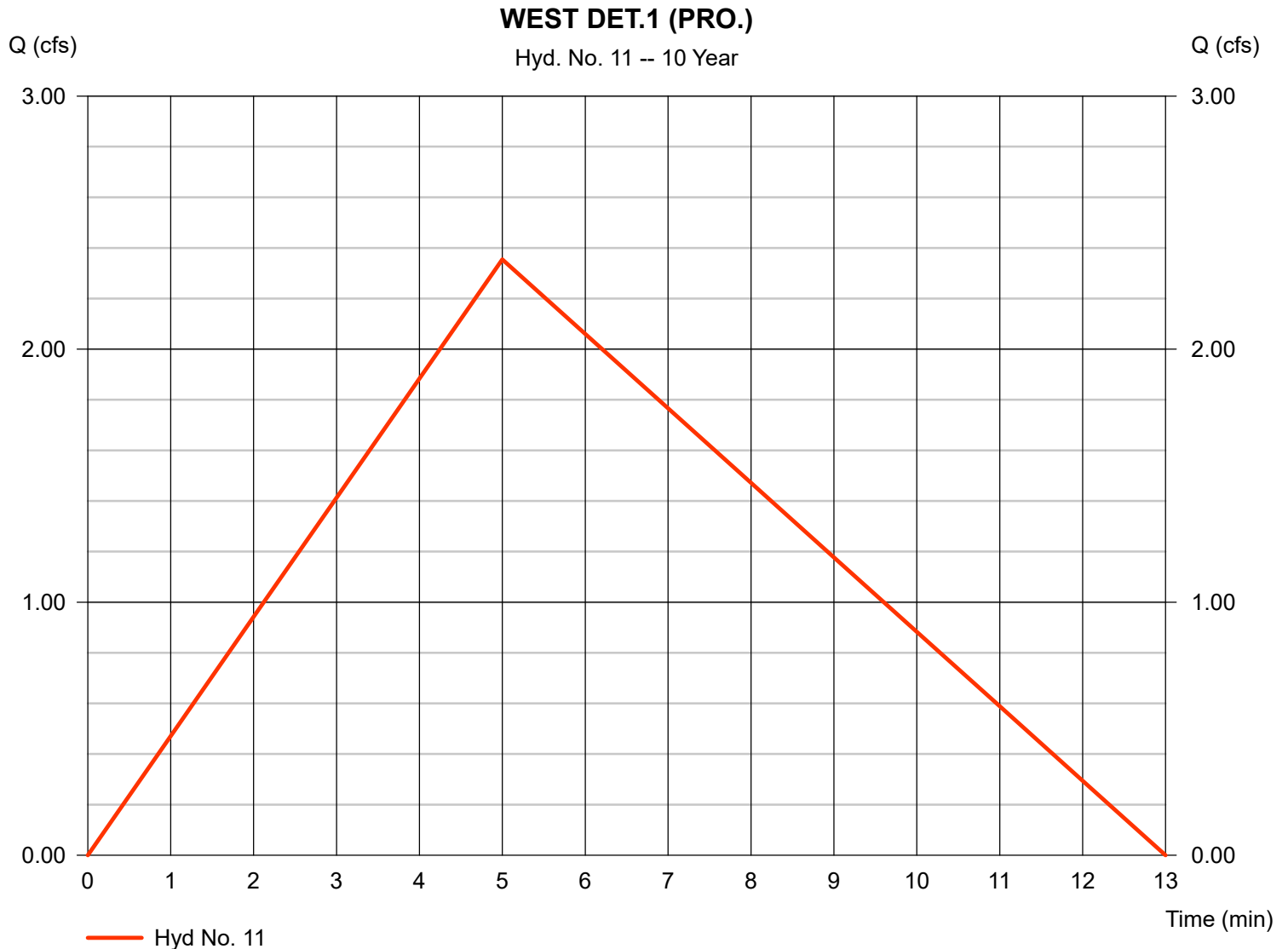

# Hydrograph Report

Hydraflow Hydrographs by Intelisolve v9.1

Friday, Dec 17, 2021

## Hyd. No. 12

WEST DET.2 (PRO.)

Hydrograph type = Rational  
 Storm frequency = 10 yrs  
 Time interval = 1 min  
 Drainage area = 0.702 ac  
 Intensity = 7.438 in/hr  
 IDF Curve = IDF CURVE.IDF

Peak discharge = 4.282 cfs  
 Time to peak = 5 min  
 Hyd. volume = 1,713 cuft  
 Runoff coeff. = 0.82  
 Tc by User = 5.00 min  
 Asc/Rec limb fact = 1/1.66667

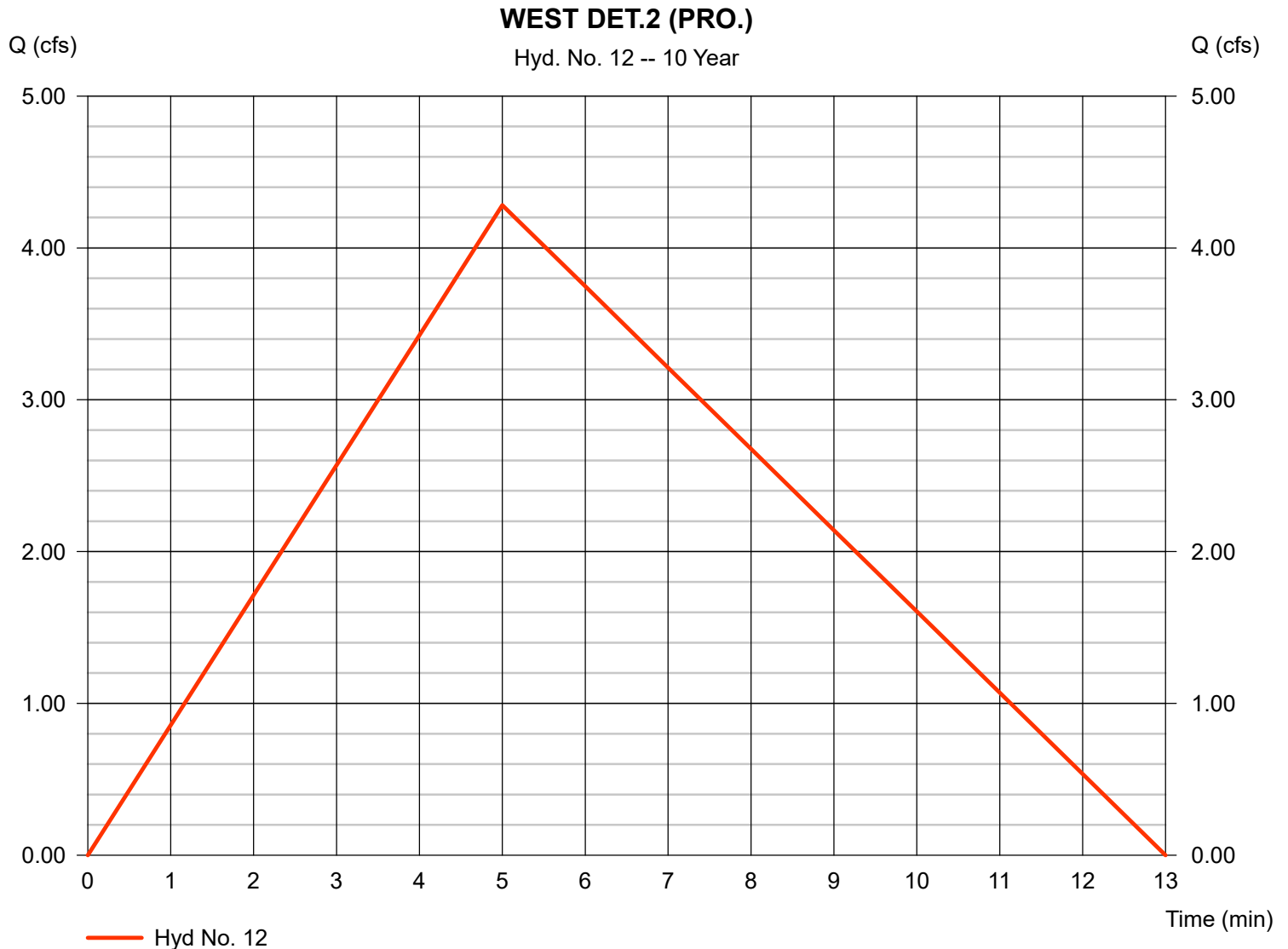



# Hydrograph Report

Hydraflow Hydrographs by Intelisolve v9.1

Friday, Dec 17, 2021

## Hyd. No. 13

Outflow (U.G. Sys. 1)

Hydrograph type	= Reservoir	Peak discharge	= 0.000 cfs
Storm frequency	= 10 yrs	Time to peak	= n/a
Time interval	= 1 min	Hyd. volume	= 0 cuft
Inflow hyd. No.	= 11 - WEST DET.1 (PRO.)	Max. Elevation	= 236.62 ft
Reservoir name	= U.G. STORAGE SYSTEM #1	Max. Storage	= 918 cuft

Storage Indication method used.

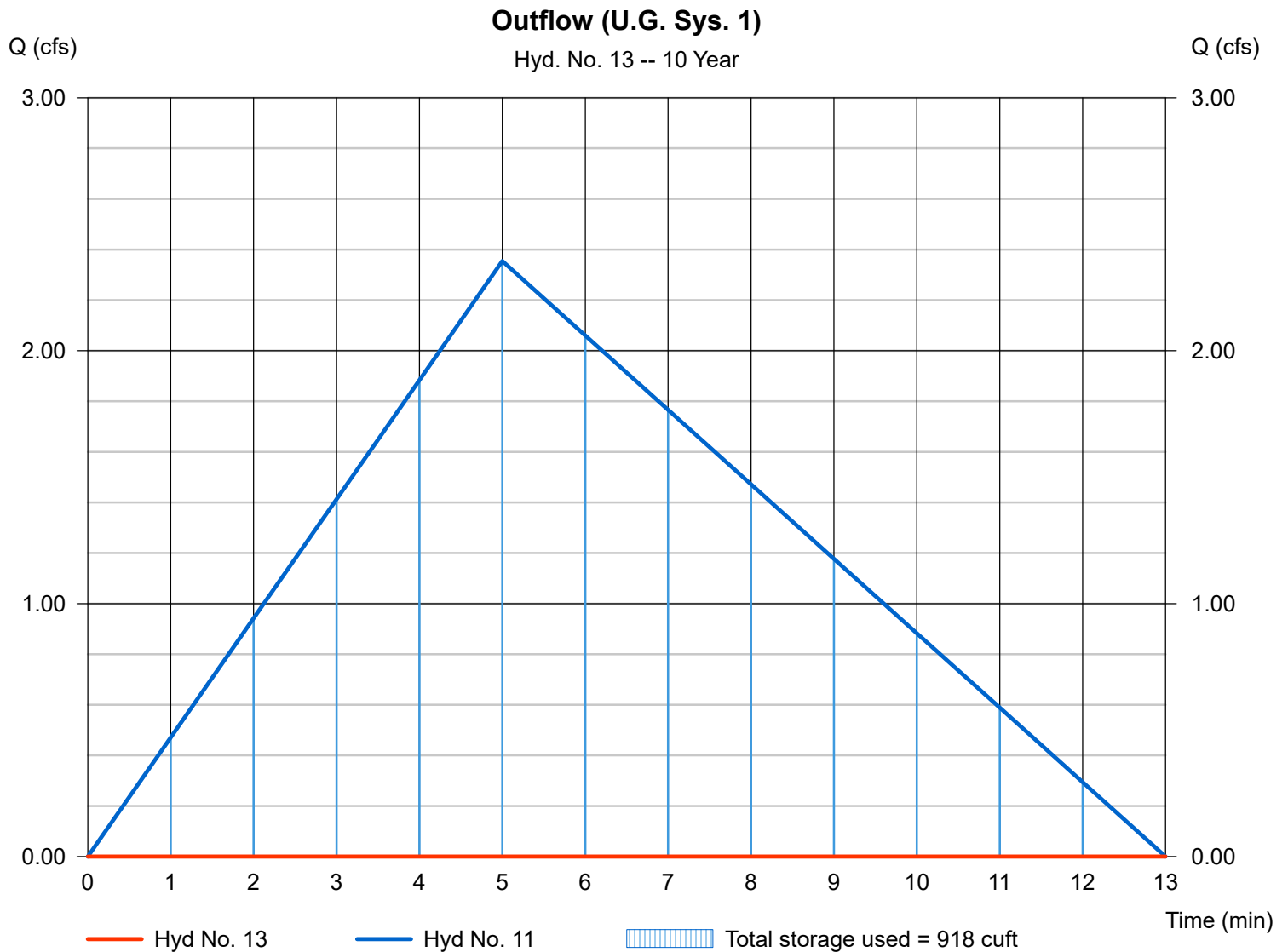

# Hydrograph Report

Hydraflow Hydrographs by Intelisolve v9.1

Friday, Dec 17, 2021

## Hyd. No. 14

Inflow (U.G. Sys. 2)

Hydrograph type = Combine  
 Storm frequency = 10 yrs  
 Time interval = 1 min  
 Inflow hyds. = 12, 13

Peak discharge = 4.282 cfs  
 Time to peak = 5 min  
 Hyd. volume = 1,670 cuft  
 Contrib. drain. area = 0.702 ac

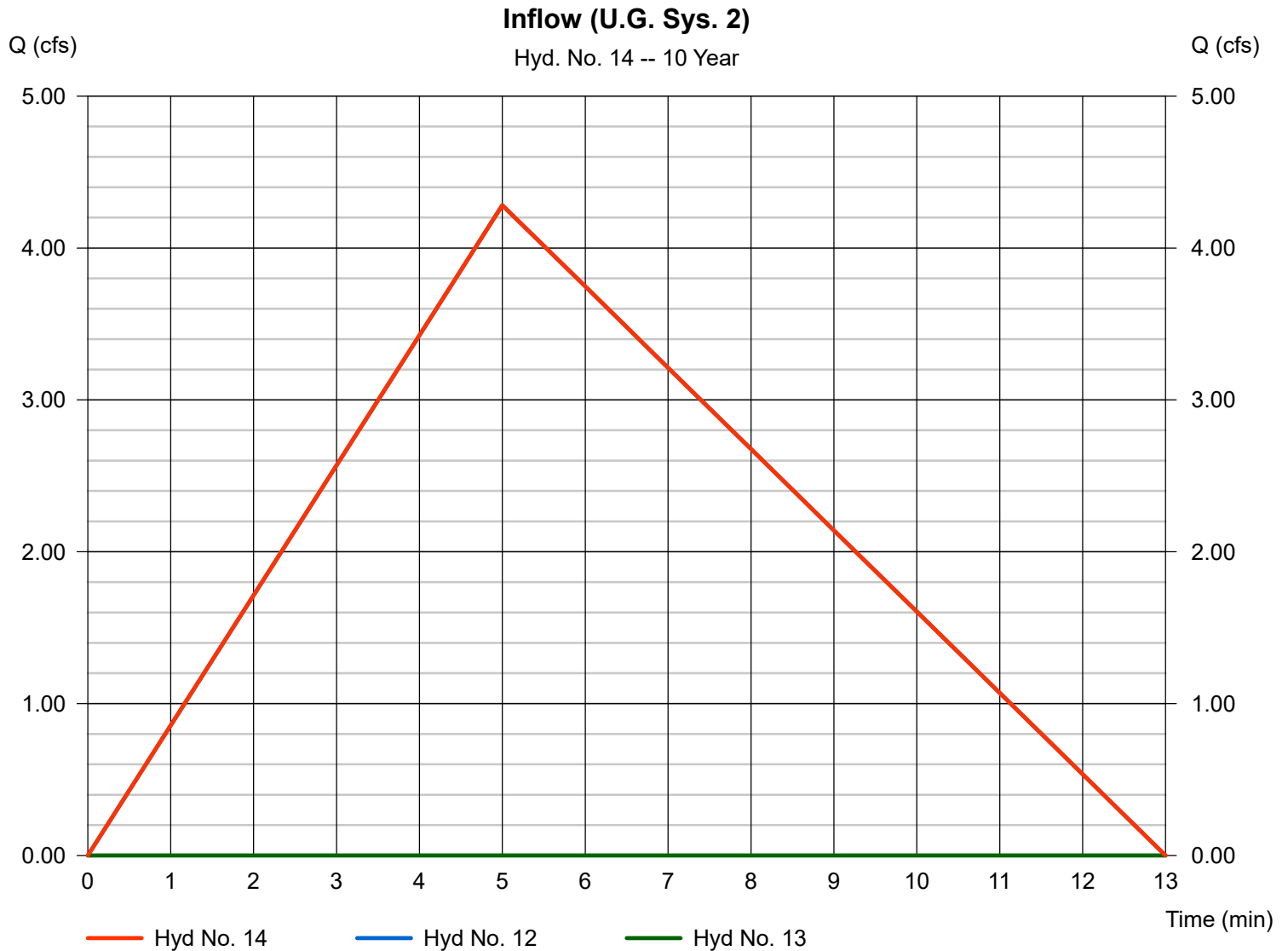

# Hydrograph Report

Hydraflow Hydrographs by Intelisolve v9.1

Friday, Dec 17, 2021

## Hyd. No. 15

Outflow (U.G. Sys. 2)

Hydrograph type	= Reservoir	Peak discharge	= 1.034 cfs
Storm frequency	= 10 yrs	Time to peak	= 11 min
Time interval	= 1 min	Hyd. volume	= 1,667 cuft
Inflow hyd. No.	= 14 - Inflow (U.G. Sys. 2)	Max. Elevation	= 231.16 ft
Reservoir name	= U.G. STORAGE SYSTEM #2	Max. Storage	= 1,179 cuft

Storage Indication method used.

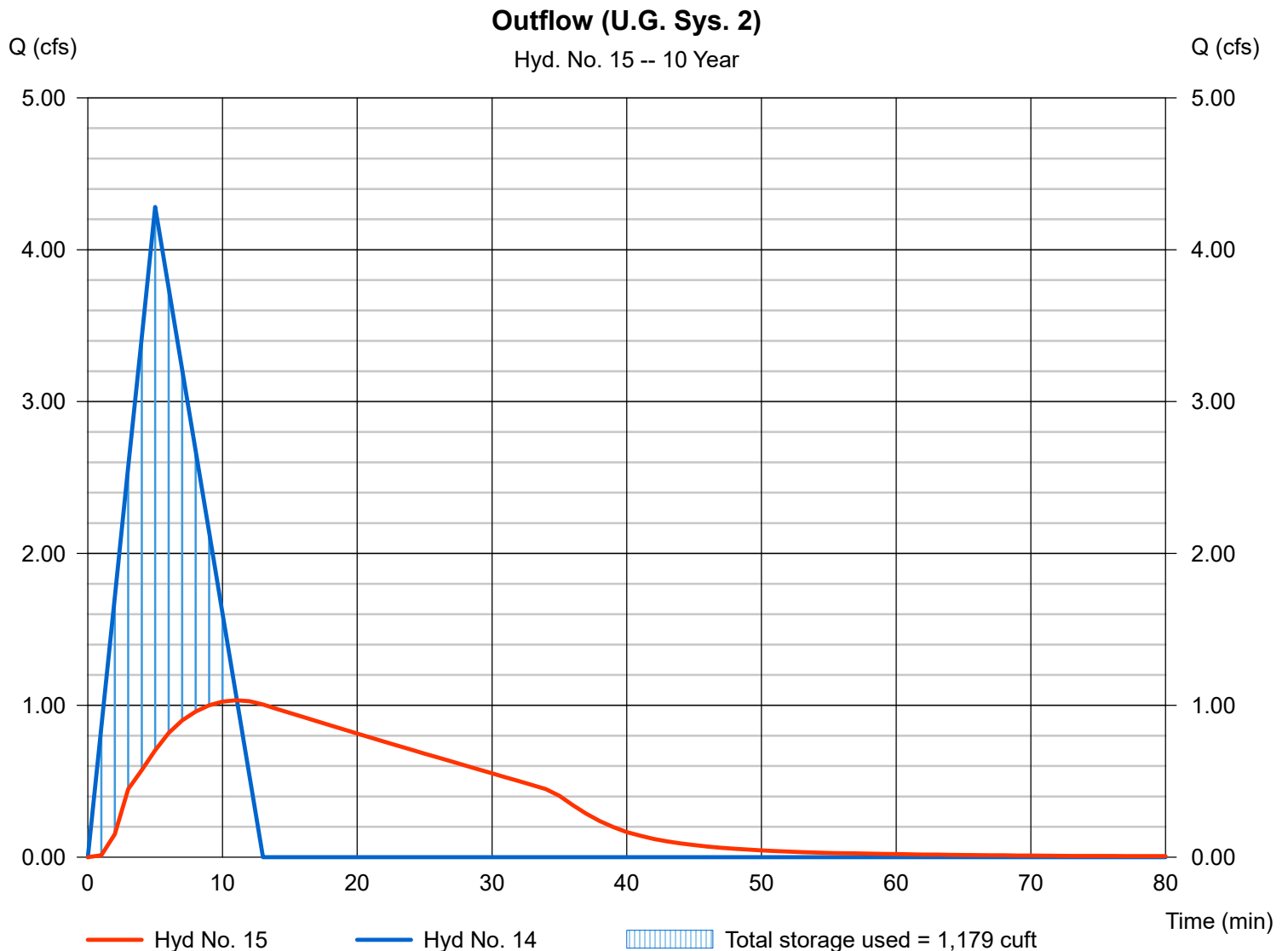

# Hydrograph Report

Hydraflow Hydrographs by Intelisolve v9.1

Friday, Dec 17, 2021

## Hyd. No. 16

TOTAL WEST (PRO)

Hydrograph type = Combine  
Storm frequency = 10 yrs  
Time interval = 1 min  
Inflow hyds. = 10, 15

Peak discharge = 4.855 cfs  
Time to peak = 7 min  
Hyd. volume = 3,803 cuft  
Contrib. drain. area = 1.710 ac

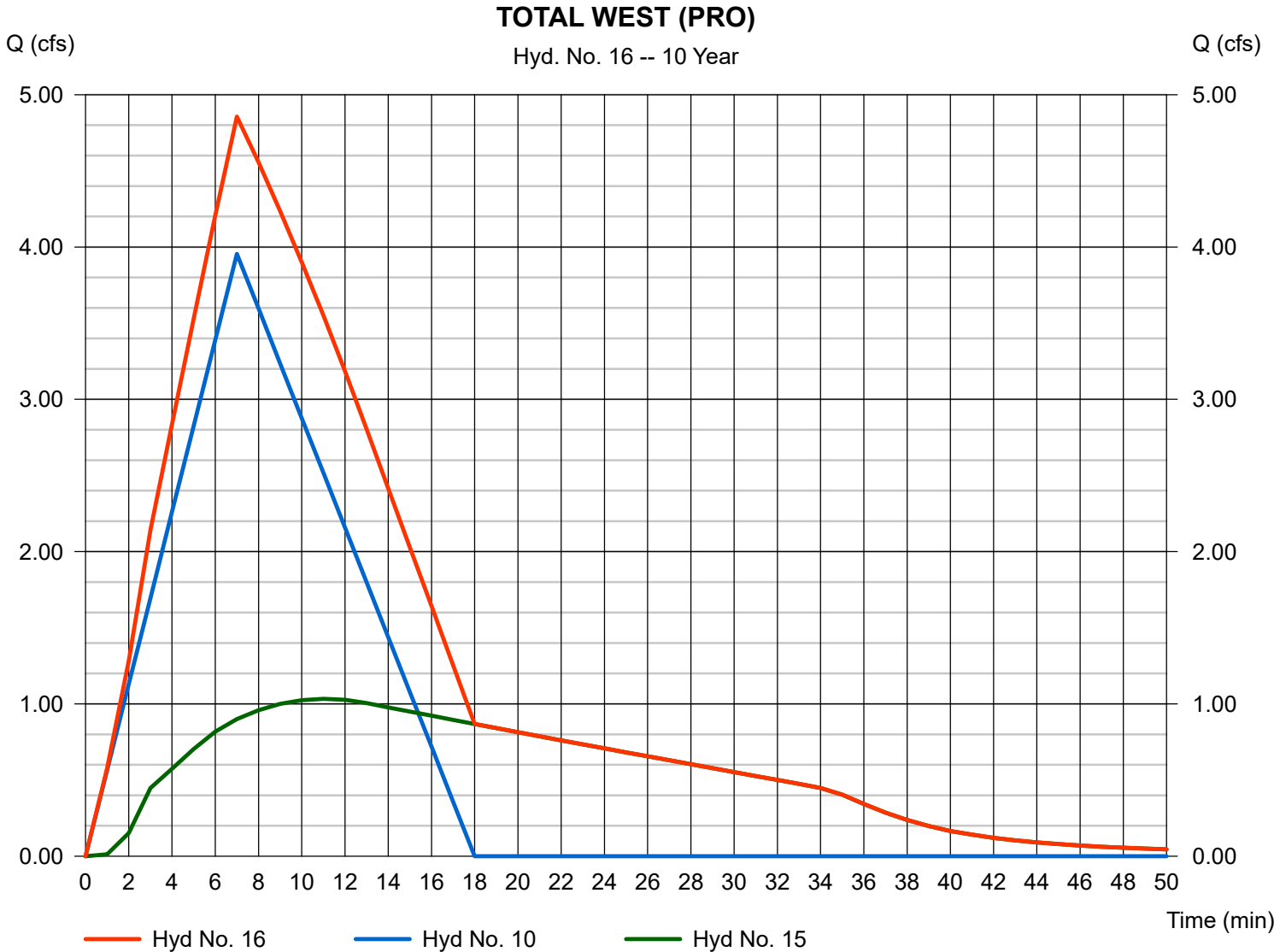

# Hydrograph Summary Report

Hydraflow Hydrographs by Intelisolve v9.1

Hyd. No.	Hydrograph type (origin)	Peak flow (cfs)	Time interval (min)	Time to peak (min)	Hyd. volume (cuft)	Inflow hyd(s)	Maximum elevation (ft)	Total strge used (cuft)	Hydrograph description	
1	Rational	12.78	1	7	7,489	----	-----	-----	EAST (EX.)	
2	Rational	6.127	1	9	4,412	----	-----	-----	WEST (EX)	
3	Rational	6.318	1	7	3,538	----	-----	-----	EAST UNDET. (PRO.)	
4	Rational	5.920	1	5	2,368	----	-----	-----	EAST DET.1 (PRO.)	
5	Rational	6.055	1	5	2,422	----	-----	-----	EAST DET.2 (PRO.)	
6	Reservoir	0.000	1	n/a	0	4	227.16	2,309	Outflow (U.G. Sys. 3)	
7	Combine	6.055	1	5	2,361	5, 6	-----	-----	Inflow (WQ Basin)	
8	Reservoir	1.010	1	12	1,807	7	213.40	1,968	Outflow (WQ Basin)	
9	Combine	7.139	1	7	5,219	3, 8	-----	-----	TOTAL EAST (PRO)	
10	Rational	4.766	1	7	2,669	----	-----	-----	WEST UNDET. (PRO.)	
11	Rational	2.839	1	5	1,136	----	-----	-----	WEST DET.1 (PRO.)	
12	Rational	5.164	1	5	2,065	----	-----	-----	WEST DET.2 (PRO.)	
13	Reservoir	0.000	1	n/a	0	11	237.11	1,107	Outflow (U.G. Sys. 1)	
14	Combine	5.164	1	5	2,014	12, 13	-----	-----	Inflow (U.G. Sys. 2)	
15	Reservoir	1.159	1	11	2,011	14	231.53	1,460	Outflow (U.G. Sys. 2)	
16	Combine	5.765	1	7	4,585	10, 15	-----	-----	TOTAL WEST (PRO)	
TAPESTRY-2021-12-17.gpw					Return Period: 25 Year			Friday, Dec 17, 2021		

# Hydrograph Report

Hydraflow Hydrographs by Intelisolve v9.1

Friday, Dec 17, 2021

## Hyd. No. 1

EAST (EX.)

Hydrograph type = Rational  
 Storm frequency = 25 yrs  
 Time interval = 1 min  
 Drainage area = 5.110 ac  
 Intensity = 7.580 in/hr  
 IDF Curve = IDF CURVE.IDF

Peak discharge = 12.78 cfs  
 Time to peak = 7 min  
 Hyd. volume = 7,489 cuft  
 Runoff coeff. = 0.33  
 Tc by TR55 = 7.32 min  
 Asc/Rec limb fact = 1/1.66667

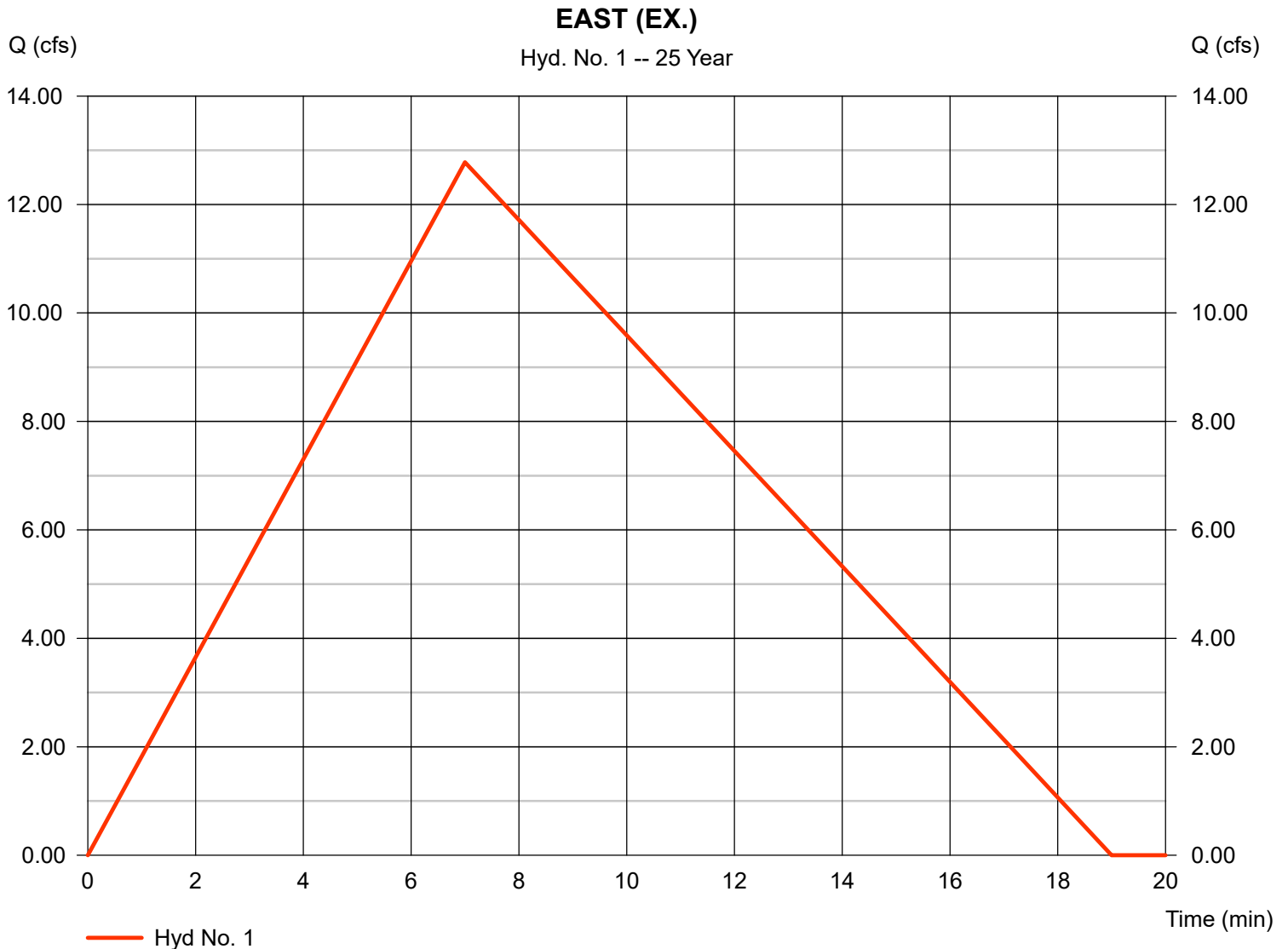

# Hydrograph Report

Hydraflow Hydrographs by Intelisolve v9.1

Friday, Dec 17, 2021

## Hyd. No. 2

WEST (EX)

Hydrograph type = Rational  
 Storm frequency = 25 yrs  
 Time interval = 1 min  
 Drainage area = 2.630 ac  
 Intensity = 6.852 in/hr  
 IDF Curve = IDF CURVE.IDF

Peak discharge = 6.127 cfs  
 Time to peak = 9 min  
 Hyd. volume = 4,412 cuft  
 Runoff coeff. = 0.34  
 Tc by TR55 = 9.00 min  
 Asc/Rec limb fact = 1/1.66667

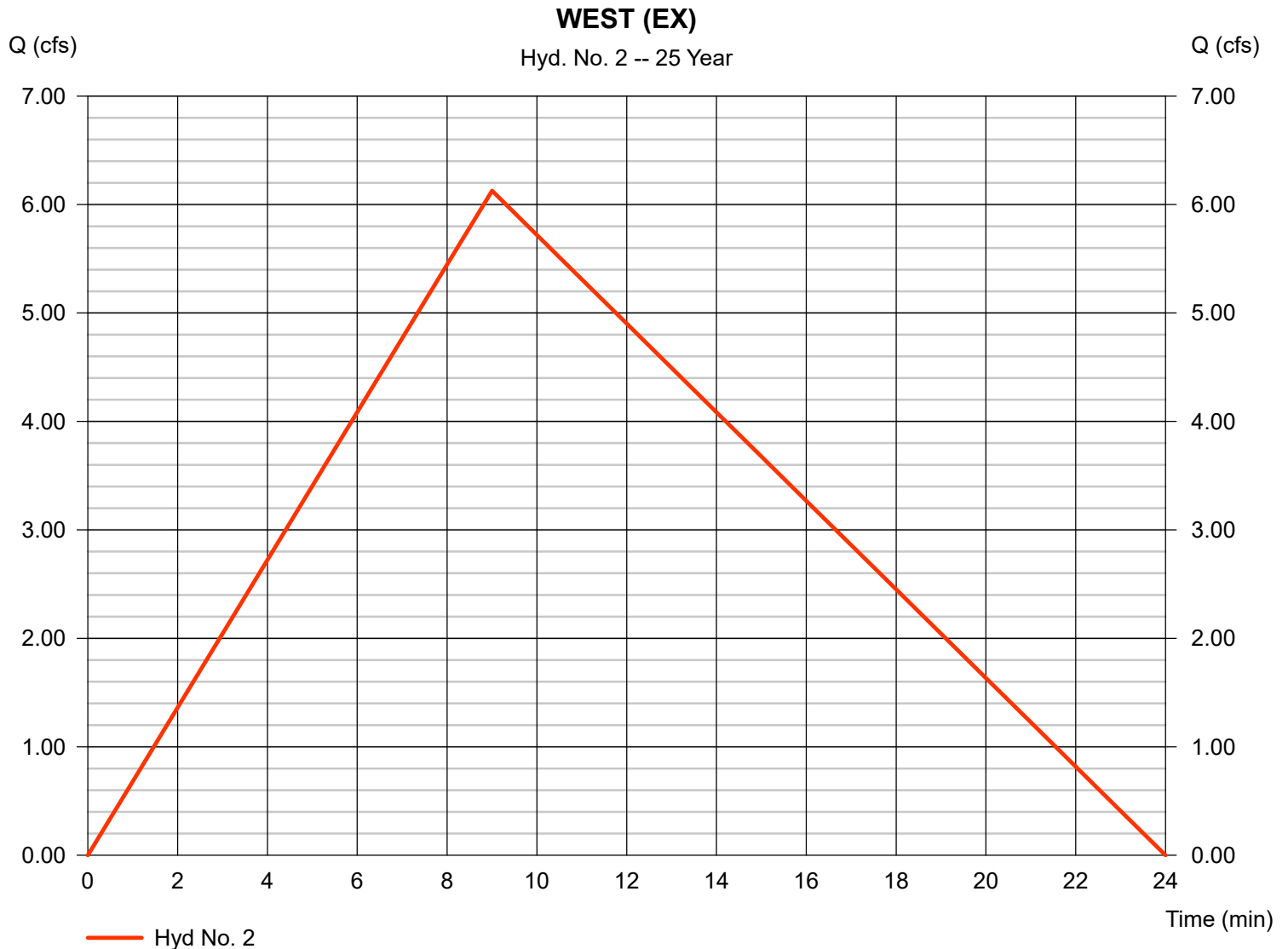

# Hydrograph Report

Hydraflow Hydrographs by Intelisolve v9.1

Friday, Dec 17, 2021

## Hyd. No. 3

EAST UNDET. (PRO.)

Hydrograph type = Rational  
 Storm frequency = 25 yrs  
 Time interval = 1 min  
 Drainage area = 2.720 ac  
 Intensity = 7.742 in/hr  
 IDF Curve = IDF CURVE.IDF

Peak discharge = 6.318 cfs  
 Time to peak = 7 min  
 Hyd. volume = 3,538 cuft  
 Runoff coeff. = 0.3  
 Tc by TR55 = 7.00 min  
 Asc/Rec limb fact = 1/1.66667

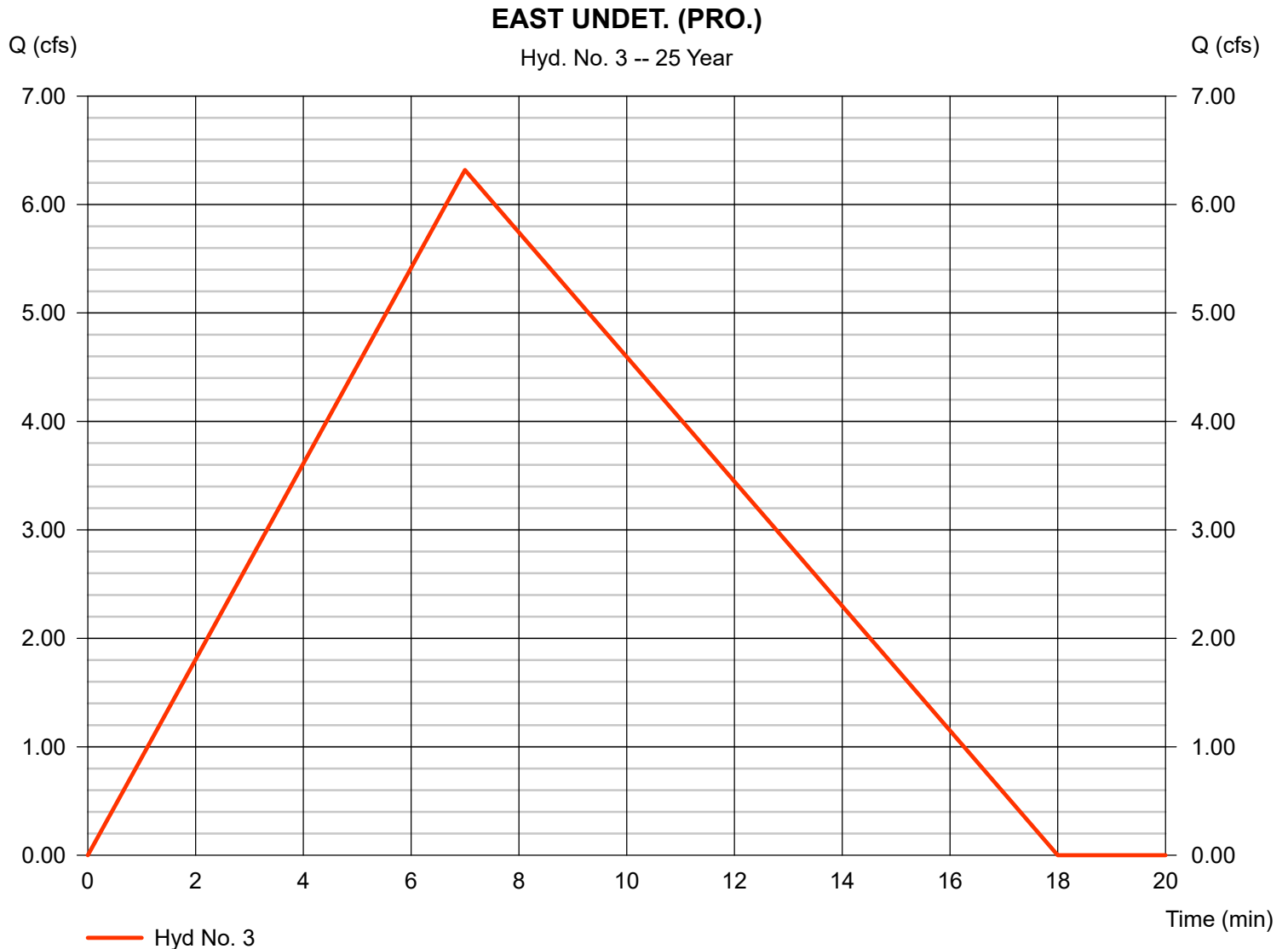



# Hydrograph Report

Hydraflow Hydrographs by Intelisolve v9.1

Friday, Dec 17, 2021

## Hyd. No. 4

EAST DET.1 (PRO.)

Hydrograph type = Rational  
 Storm frequency = 25 yrs  
 Time interval = 1 min  
 Drainage area = 1.320 ac  
 Intensity = 8.970 in/hr  
 IDF Curve = IDF CURVE.IDF

Peak discharge = 5.920 cfs  
 Time to peak = 5 min  
 Hyd. volume = 2,368 cuft  
 Runoff coeff. = 0.5  
 Tc by User = 5.00 min  
 Asc/Rec limb fact = 1/1.66667

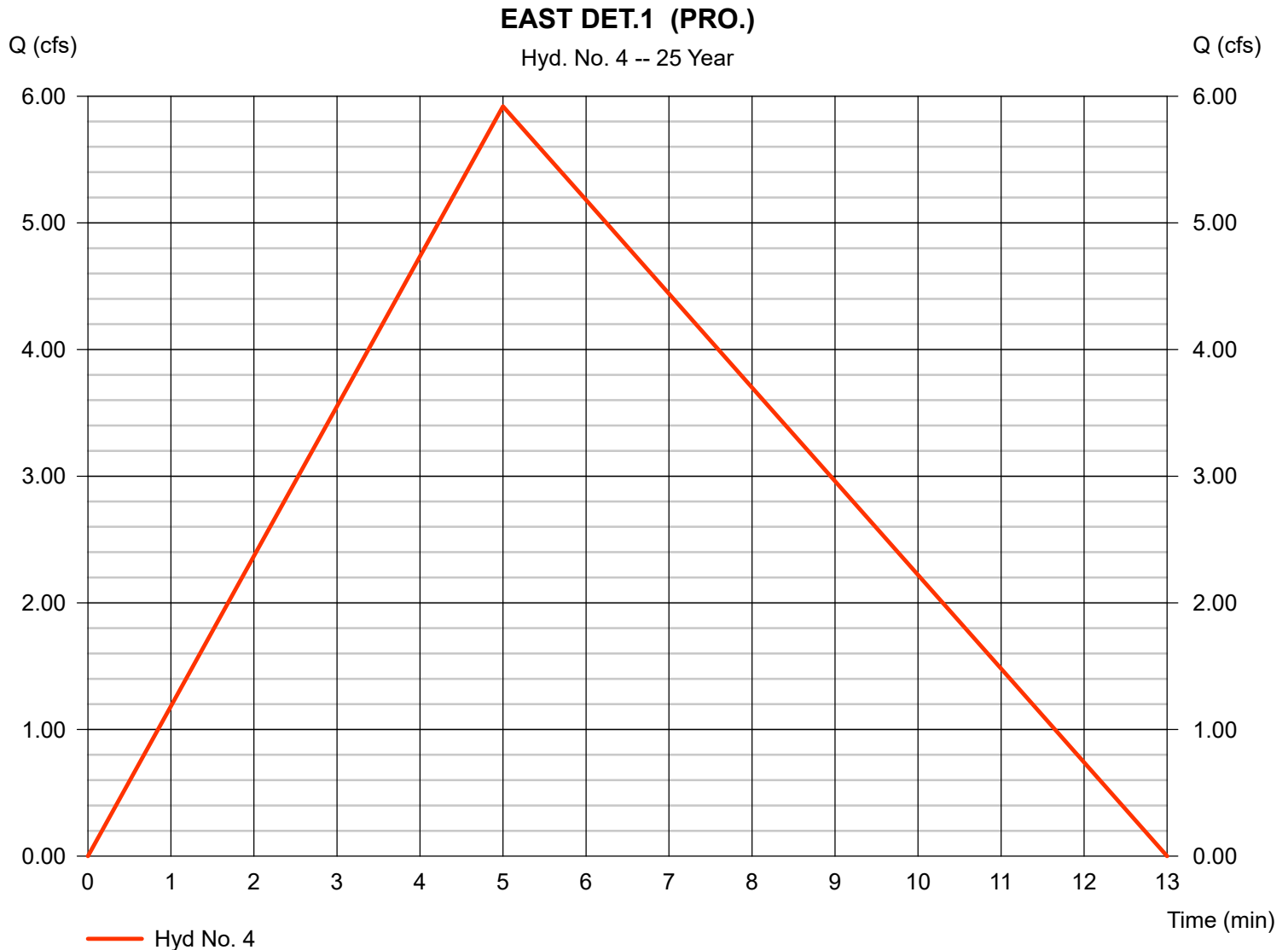

# Hydrograph Report

Hydraflow Hydrographs by Intelisolve v9.1

Friday, Dec 17, 2021

## Hyd. No. 5

EAST DET.2 (PRO.)

Hydrograph type = Rational  
 Storm frequency = 25 yrs  
 Time interval = 1 min  
 Drainage area = 0.900 ac  
 Intensity = 8.970 in/hr  
 IDF Curve = IDF CURVE.IDF

Peak discharge = 6.055 cfs  
 Time to peak = 5 min  
 Hyd. volume = 2,422 cuft  
 Runoff coeff. = 0.75  
 Tc by User = 5.00 min  
 Asc/Rec limb fact = 1/1.66667

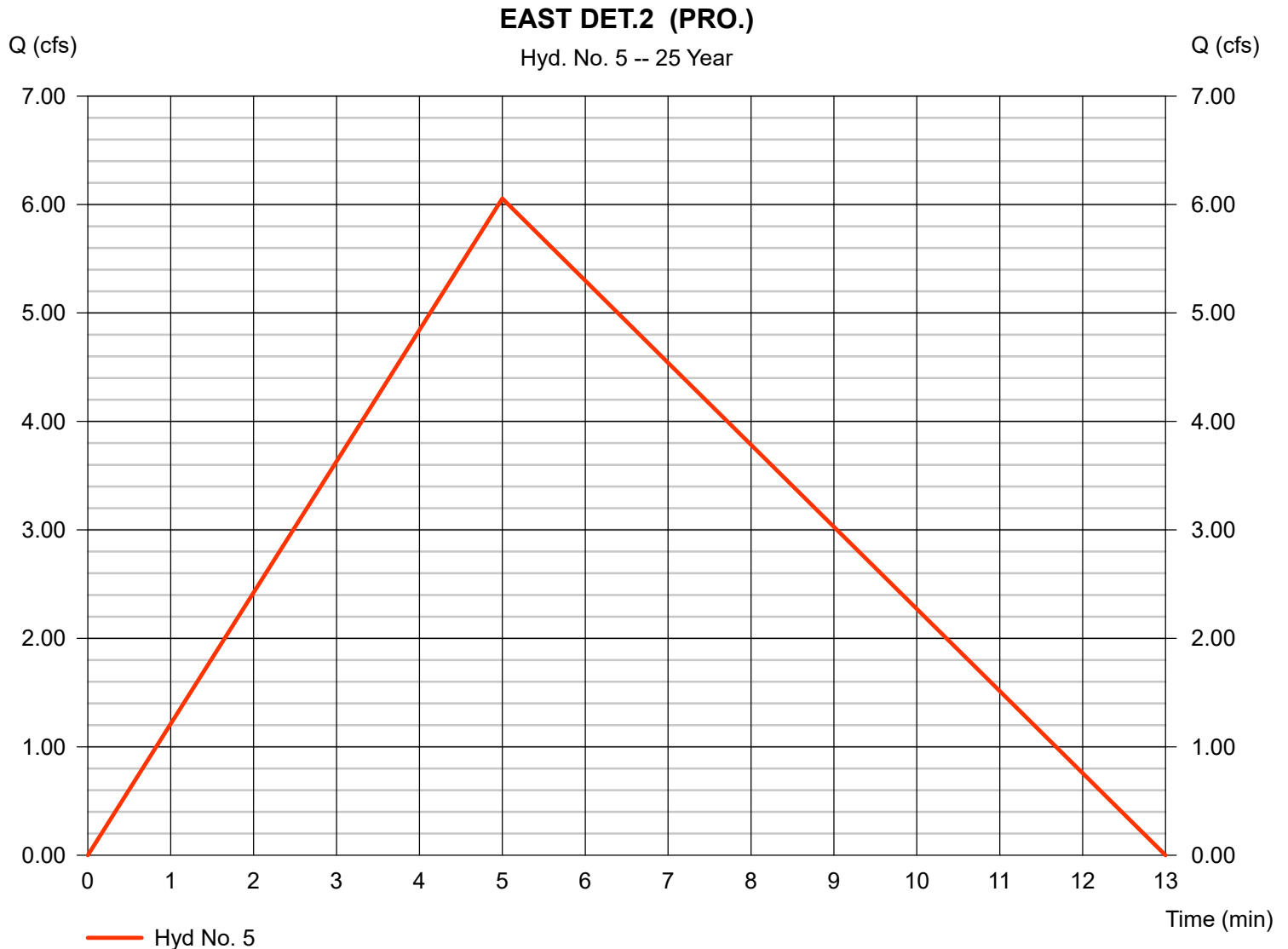

# Hydrograph Report

Hydraflow Hydrographs by Intelisolve v9.1

Friday, Dec 17, 2021

## Hyd. No. 6

Outflow (U.G. Sys. 3)

Hydrograph type	= Reservoir	Peak discharge	= 0.000 cfs
Storm frequency	= 25 yrs	Time to peak	= n/a
Time interval	= 1 min	Hyd. volume	= 0 cuft
Inflow hyd. No.	= 4 - EAST DET.1 (PRO.)	Max. Elevation	= 227.16 ft
Reservoir name	= U.G. STORAGE SYSTEM #3	Max. Storage	= 2,309 cuft

Storage Indication method used.

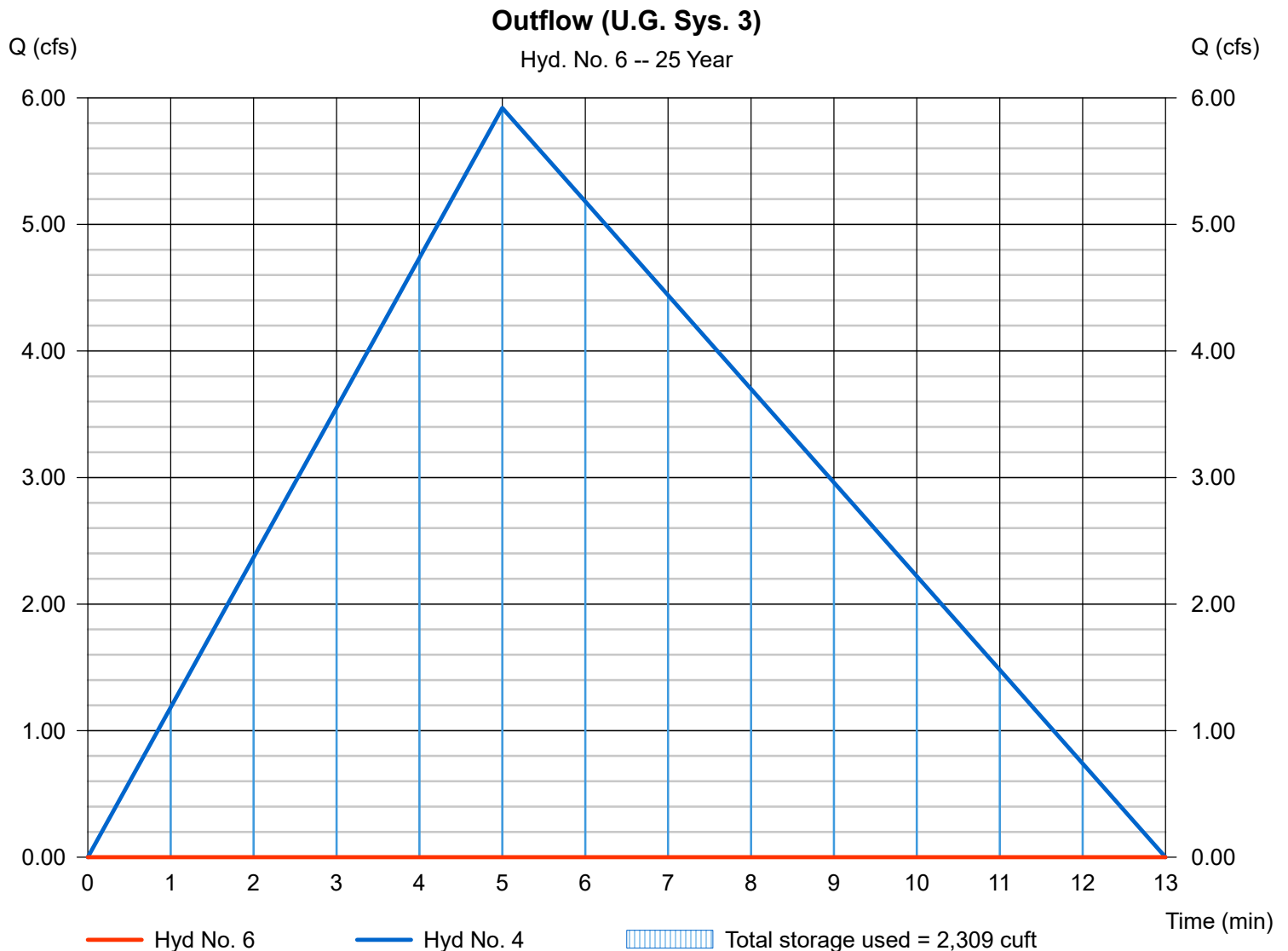

# Hydrograph Report

Hydraflow Hydrographs by Intelisolve v9.1

Friday, Dec 17, 2021

## Hyd. No. 7

Inflow (WQ Basin)

Hydrograph type = Combine  
Storm frequency = 25 yrs  
Time interval = 1 min  
Inflow hyds. = 5, 6

Peak discharge = 6.055 cfs  
Time to peak = 5 min  
Hyd. volume = 2,361 cuft  
Contrib. drain. area = 0.900 ac

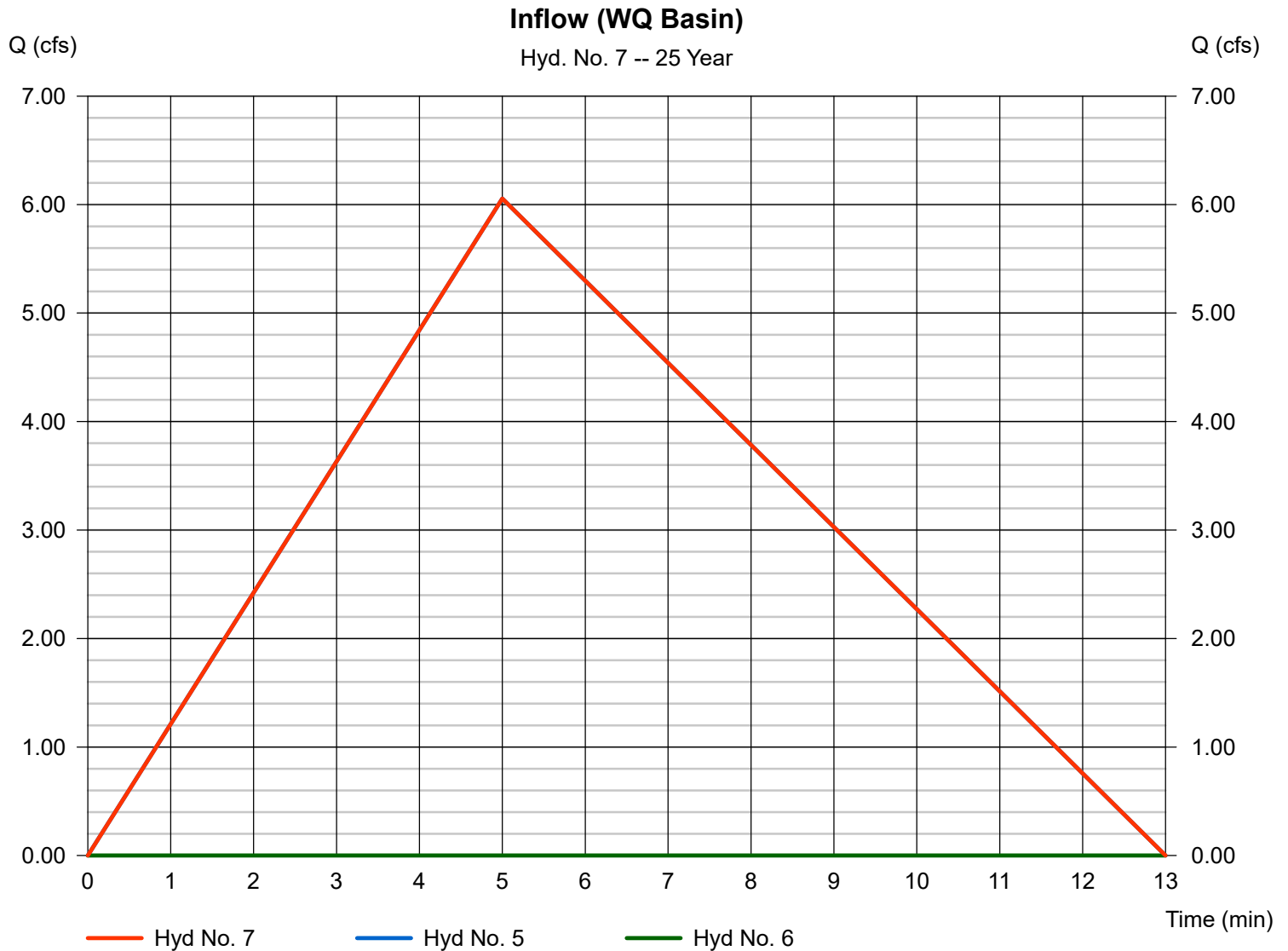

# Hydrograph Report

Hydraflow Hydrographs by Intelisolve v9.1

Friday, Dec 17, 2021

## Hyd. No. 8

Outflow (WQ Basin)

Hydrograph type = Reservoir  
 Storm frequency = 25 yrs  
 Time interval = 1 min  
 Inflow hyd. No. = 7 - Inflow (WQ Basin)  
 Reservoir name = WQ BASIN

Peak discharge = 1.010 cfs  
 Time to peak = 12 min  
 Hyd. volume = 1,807 cuft  
 Max. Elevation = 213.40 ft  
 Max. Storage = 1,968 cuft

Storage Indication method used.

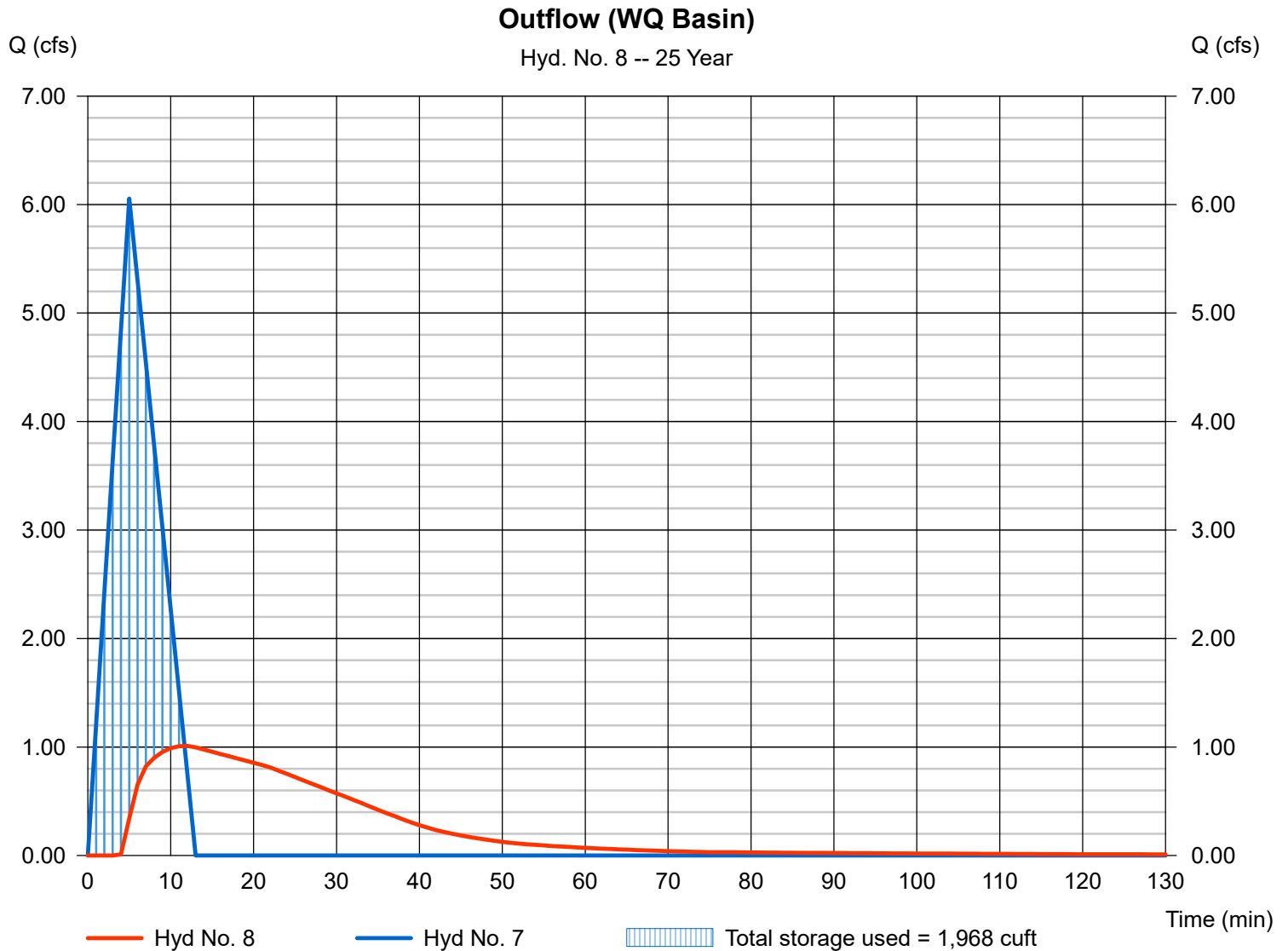

# Hydrograph Report

Hydraflow Hydrographs by Intelisolve v9.1

Friday, Dec 17, 2021

## Hyd. No. 9

TOTAL EAST (PRO)

Hydrograph type = Combine  
Storm frequency = 25 yrs  
Time interval = 1 min  
Inflow hyds. = 3, 8

Peak discharge = 7.139 cfs  
Time to peak = 7 min  
Hyd. volume = 5,219 cuft  
Contrib. drain. area = 2.720 ac

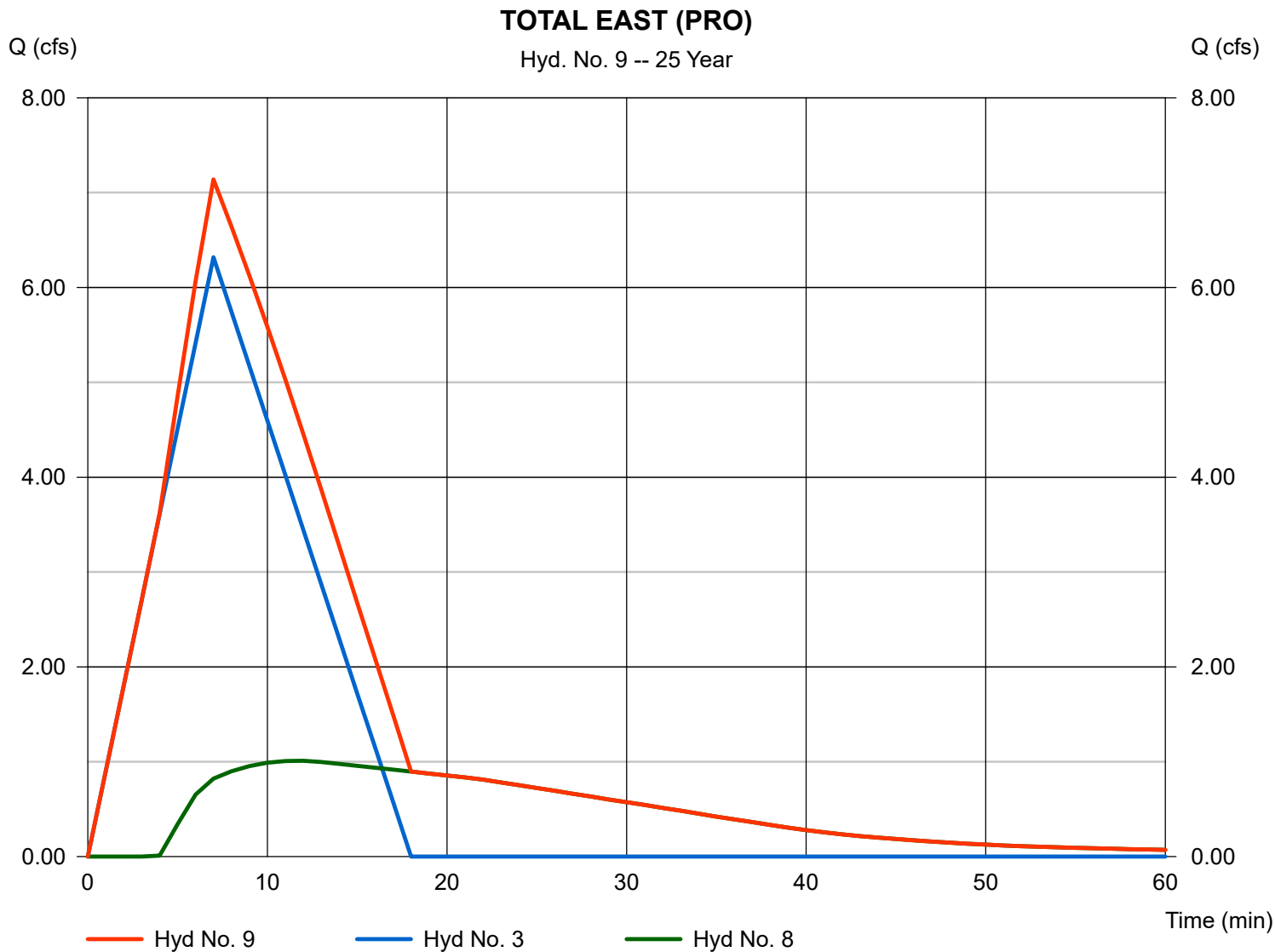

# Hydrograph Report

Hydraflow Hydrographs by Intelisolve v9.1

Friday, Dec 17, 2021

## Hyd. No. 10

WEST UNDET. (PRO.)

Hydrograph type = Rational  
 Storm frequency = 25 yrs  
 Time interval = 1 min  
 Drainage area = 1.710 ac  
 Intensity = 7.742 in/hr  
 IDF Curve = IDF CURVE.IDF

Peak discharge = 4.766 cfs  
 Time to peak = 7 min  
 Hyd. volume = 2,669 cuft  
 Runoff coeff. = 0.36  
 Tc by TR55 = 7.00 min  
 Asc/Rec limb fact = 1/1.66667

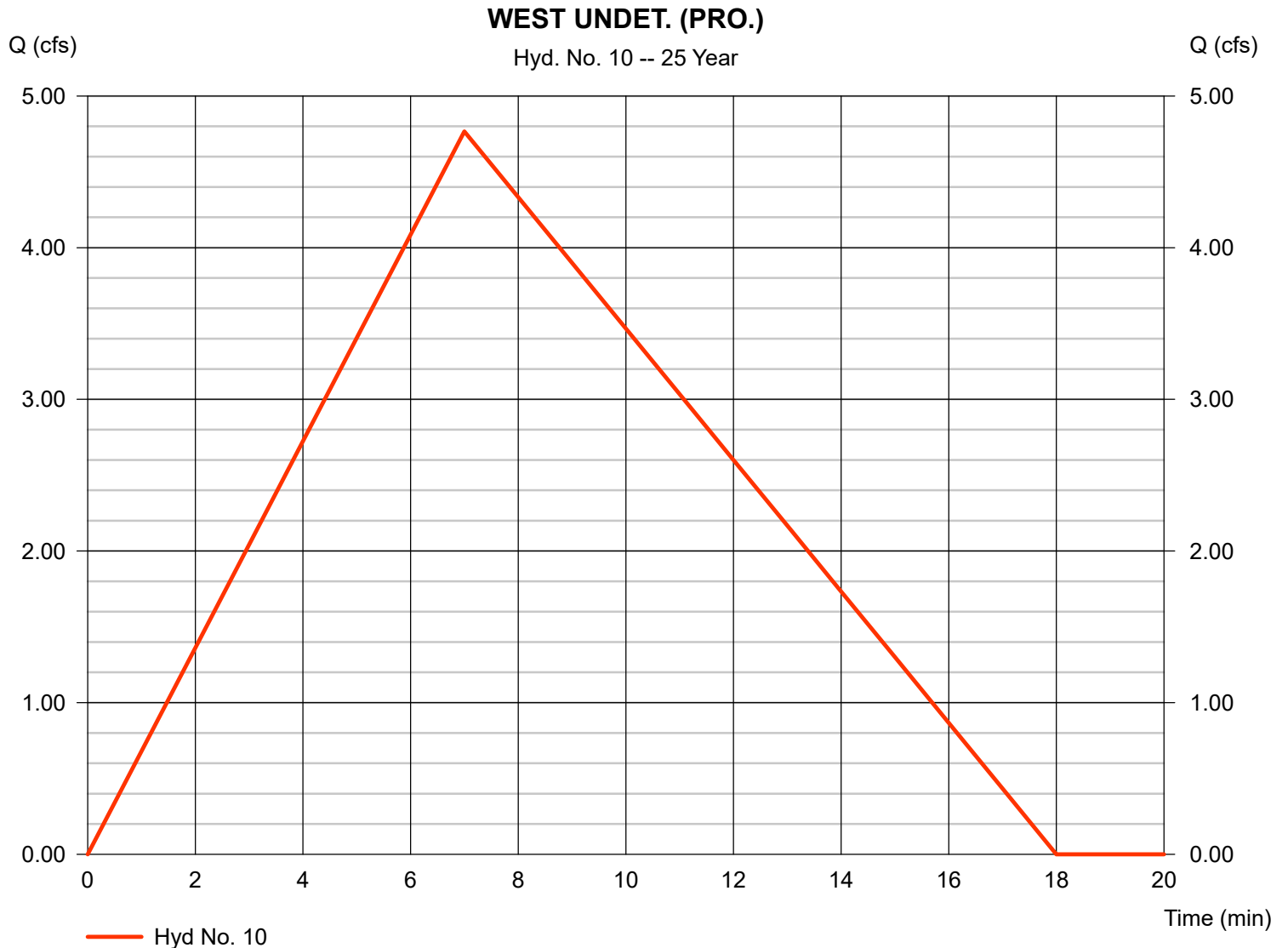

# Hydrograph Report

Hydraflow Hydrographs by Intelisolve v9.1

Friday, Dec 17, 2021

## Hyd. No. 11

WEST DET.1 (PRO.)

Hydrograph type = Rational  
 Storm frequency = 25 yrs  
 Time interval = 1 min  
 Drainage area = 0.386 ac  
 Intensity = 8.970 in/hr  
 IDF Curve = IDF CURVE.IDF

Peak discharge = 2.839 cfs  
 Time to peak = 5 min  
 Hyd. volume = 1,136 cuft  
 Runoff coeff. = 0.82  
 Tc by User = 5.00 min  
 Asc/Rec limb fact = 1/1.66667





# Hydrograph Report

Hydraflow Hydrographs by Intelisolve v9.1

Friday, Dec 17, 2021

## Hyd. No. 12

WEST DET.2 (PRO.)

Hydrograph type = Rational  
Storm frequency = 25 yrs  
Time interval = 1 min  
Drainage area = 0.702 ac  
Intensity = 8.970 in/hr  
IDF Curve = IDF CURVE.IDF

Peak discharge = 5.164 cfs  
Time to peak = 5 min  
Hyd. volume = 2,065 cuft  
Runoff coeff. = 0.82  
Tc by User = 5.00 min  
Asc/Rec limb fact = 1/1.66667

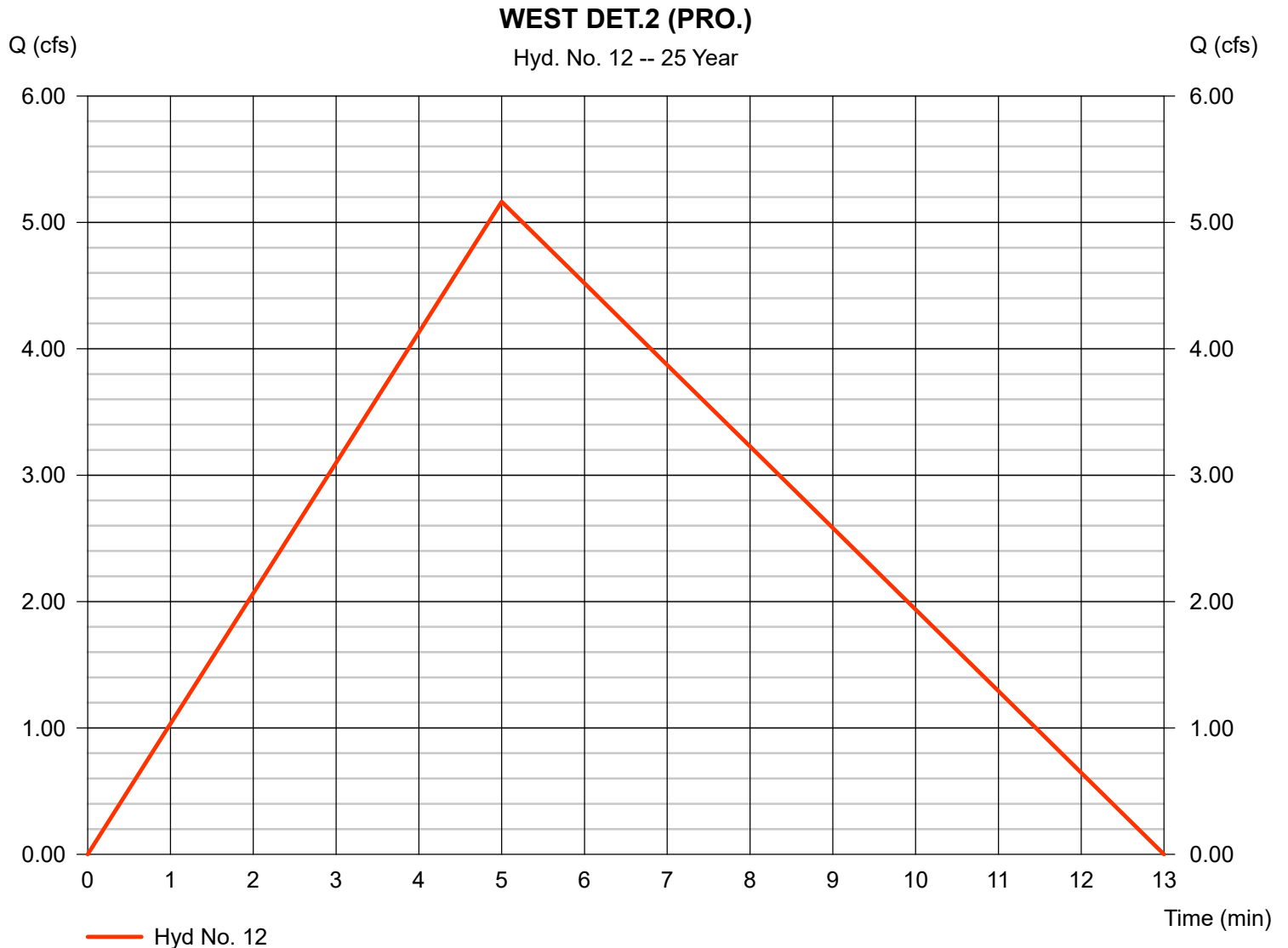

# Hydrograph Report

Hydraflow Hydrographs by Intelisolve v9.1

Friday, Dec 17, 2021

## Hyd. No. 13

Outflow (U.G. Sys. 1)

Hydrograph type	= Reservoir	Peak discharge	= 0.000 cfs
Storm frequency	= 25 yrs	Time to peak	= n/a
Time interval	= 1 min	Hyd. volume	= 0 cuft
Inflow hyd. No.	= 11 - WEST DET.1 (PRO.)	Max. Elevation	= 237.11 ft
Reservoir name	= U.G. STORAGE SYSTEM #1	Max. Storage	= 1,107 cuft

Storage Indication method used.

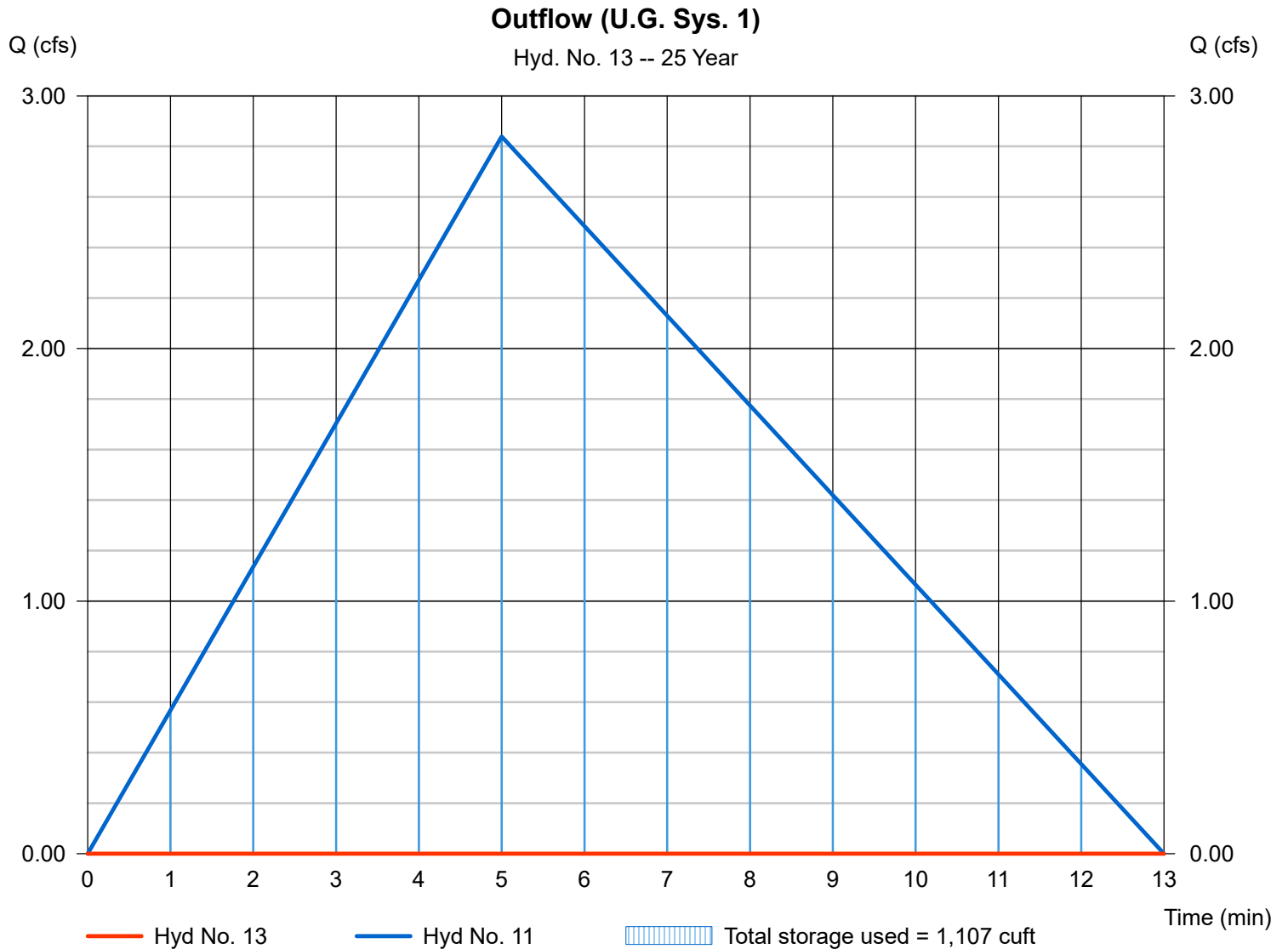

# Hydrograph Report

Hydraflow Hydrographs by Intelisolve v9.1

Friday, Dec 17, 2021

## Hyd. No. 14

Inflow (U.G. Sys. 2)

Hydrograph type = Combine  
Storm frequency = 25 yrs  
Time interval = 1 min  
Inflow hyds. = 12, 13

Peak discharge = 5.164 cfs  
Time to peak = 5 min  
Hyd. volume = 2,014 cuft  
Contrib. drain. area = 0.702 ac

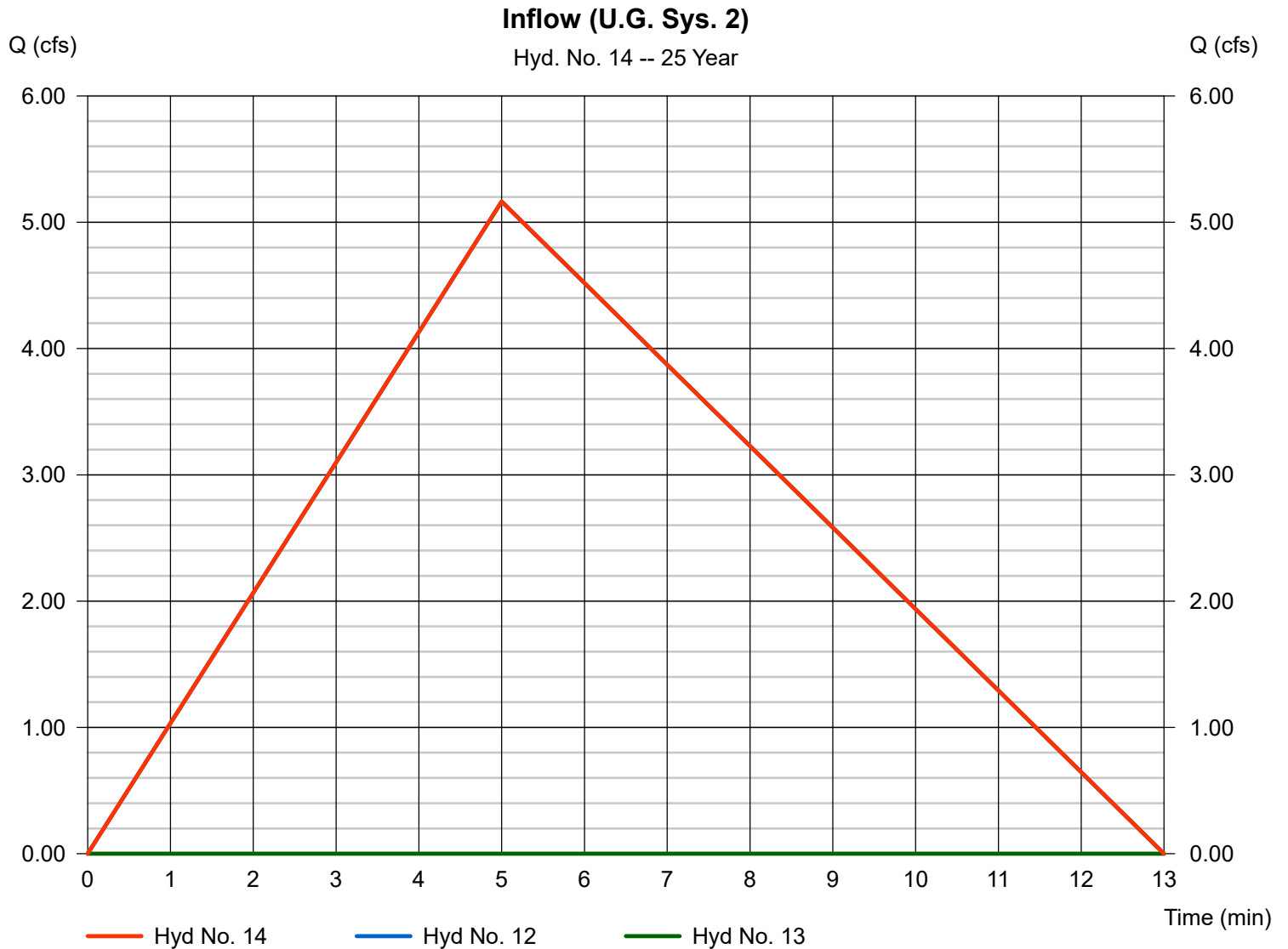

# Hydrograph Report

Hydraflow Hydrographs by Intelisolve v9.1

Friday, Dec 17, 2021

## Hyd. No. 15

Outflow (U.G. Sys. 2)

Hydrograph type	= Reservoir	Peak discharge	= 1.159 cfs
Storm frequency	= 25 yrs	Time to peak	= 11 min
Time interval	= 1 min	Hyd. volume	= 2,011 cuft
Inflow hyd. No.	= 14 - Inflow (U.G. Sys. 2)	Max. Elevation	= 231.53 ft
Reservoir name	= U.G. STORAGE SYSTEM #2	Max. Storage	= 1,460 cuft

Storage Indication method used.

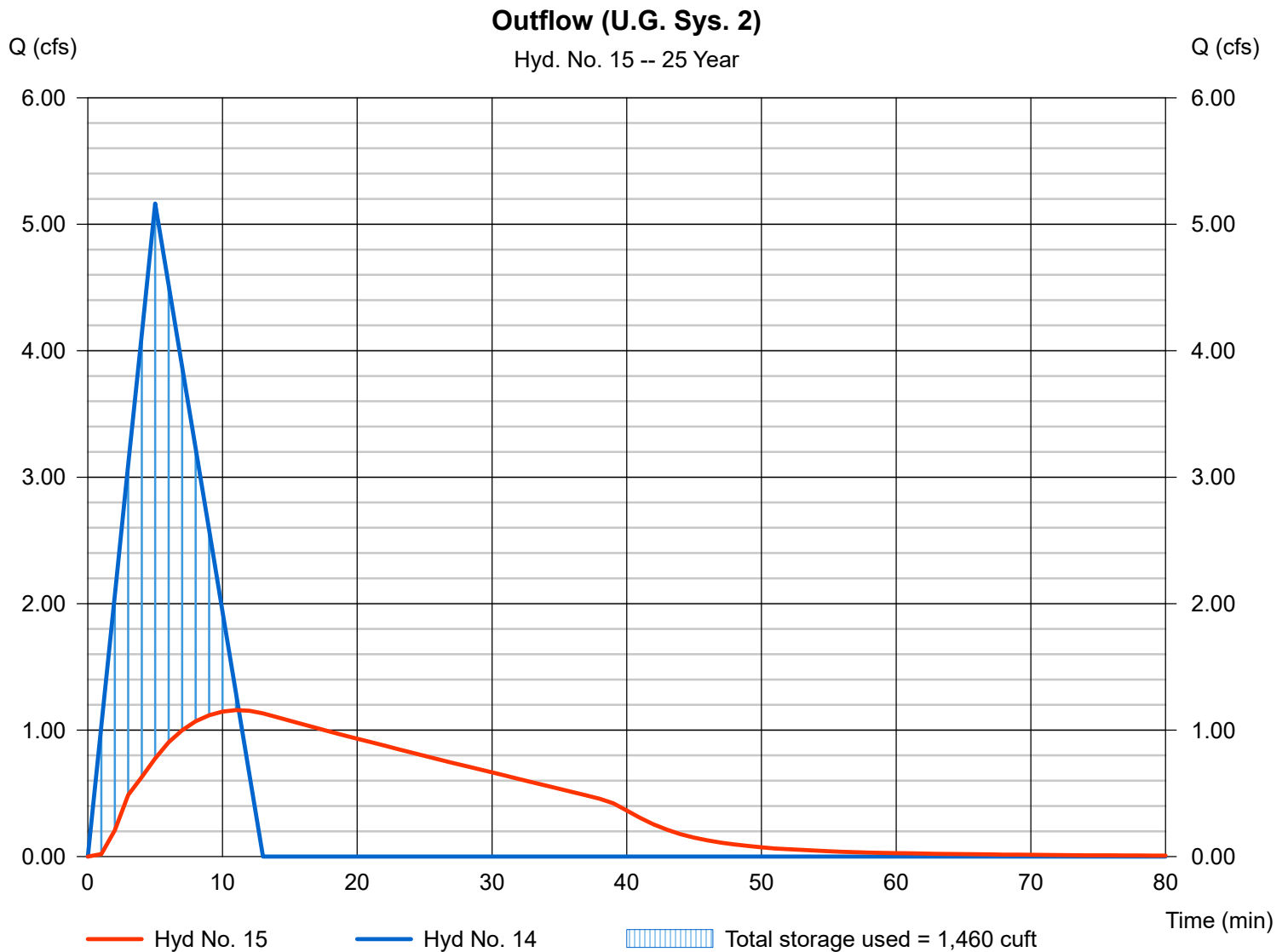

# Hydrograph Report

Hydraflow Hydrographs by Intelisolve v9.1

Friday, Dec 17, 2021

## Hyd. No. 16

TOTAL WEST (PRO)

Hydrograph type = Combine  
 Storm frequency = 25 yrs  
 Time interval = 1 min  
 Inflow hyds. = 10, 15

Peak discharge = 5.765 cfs  
 Time to peak = 7 min  
 Hyd. volume = 4,585 cuft  
 Contrib. drain. area = 1.710 ac

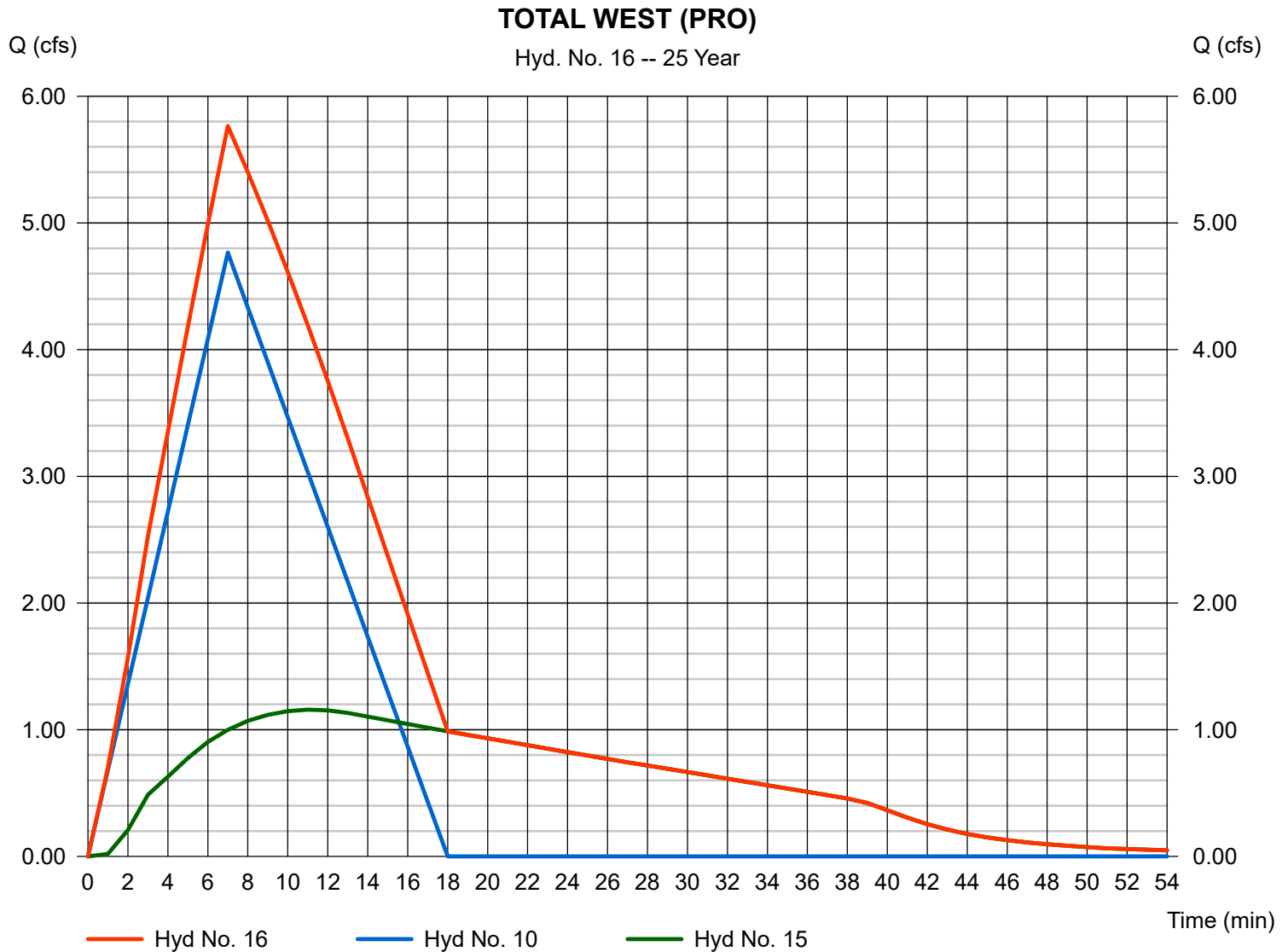

# Hydrograph Summary Report

Hydraflow Hydrographs by Intelisolve v9.1

Hyd. No.	Hydrograph type (origin)	Peak flow (cfs)	Time interval (min)	Time to peak (min)	Hyd. volume (cuft)	Inflow hyd(s)	Maximum elevation (ft)	Total strge used (cuft)	Hydrograph description	
1	Rational	14.49	1	7	8,492	---	-----	-----	EAST (EX.)	
2	Rational	6.942	1	9	4,998	---	-----	-----	WEST (EX)	
3	Rational	7.165	1	7	4,012	---	-----	-----	EAST UNDET. (PRO.)	
4	Rational	6.726	1	5	2,690	---	-----	-----	EAST DET.1 (PRO.)	
5	Rational	6.879	1	5	2,752	---	-----	-----	EAST DET.2 (PRO.)	
6	Reservoir	0.000	1	n/a	0	4	227.70	2,623	Outflow (U.G. Sys. 3)	
7	Combine	6.879	1	5	2,683	5, 6	-----	-----	Inflow (WQ Basin)	
8	Reservoir	1.098	1	12	2,129	7	213.60	2,241	Outflow (WQ Basin)	
9	Combine	8.061	1	7	5,998	3, 8	-----	-----	TOTAL EAST (PRO)	
10	Rational	5.405	1	7	3,027	---	-----	-----	WEST UNDET. (PRO.)	
11	Rational	3.226	1	5	1,290	---	-----	-----	WEST DET.1 (PRO.)	
12	Rational	5.866	1	5	2,347	---	-----	-----	WEST DET.2 (PRO.)	
13	Reservoir	0.000	1	n/a	0	11	237.63	1,258	Outflow (U.G. Sys. 1)	
14	Combine	5.866	1	5	2,288	12, 13	-----	-----	Inflow (U.G. Sys. 2)	
15	Reservoir	1.261	1	11	2,285	14	231.86	1,686	Outflow (U.G. Sys. 2)	
16	Combine	6.480	1	7	5,204	10, 15	-----	-----	TOTAL WEST (PRO)	
TAPESTRY-2021-12-17.gpw					Return Period: 50 Year			Friday, Dec 17, 2021		

# Hydrograph Report

Hydraflow Hydrographs by Intelisolve v9.1

Friday, Dec 17, 2021

## Hyd. No. 1

EAST (EX.)

Hydrograph type = Rational  
Storm frequency = 50 yrs  
Time interval = 1 min  
Drainage area = 5.110 ac  
Intensity = 8.594 in/hr  
IDF Curve = IDF CURVE.IDF

Peak discharge = 14.49 cfs  
Time to peak = 7 min  
Hyd. volume = 8,492 cuft  
Runoff coeff. = 0.33  
Tc by TR55 = 7.32 min  
Asc/Rec limb fact = 1/1.66667

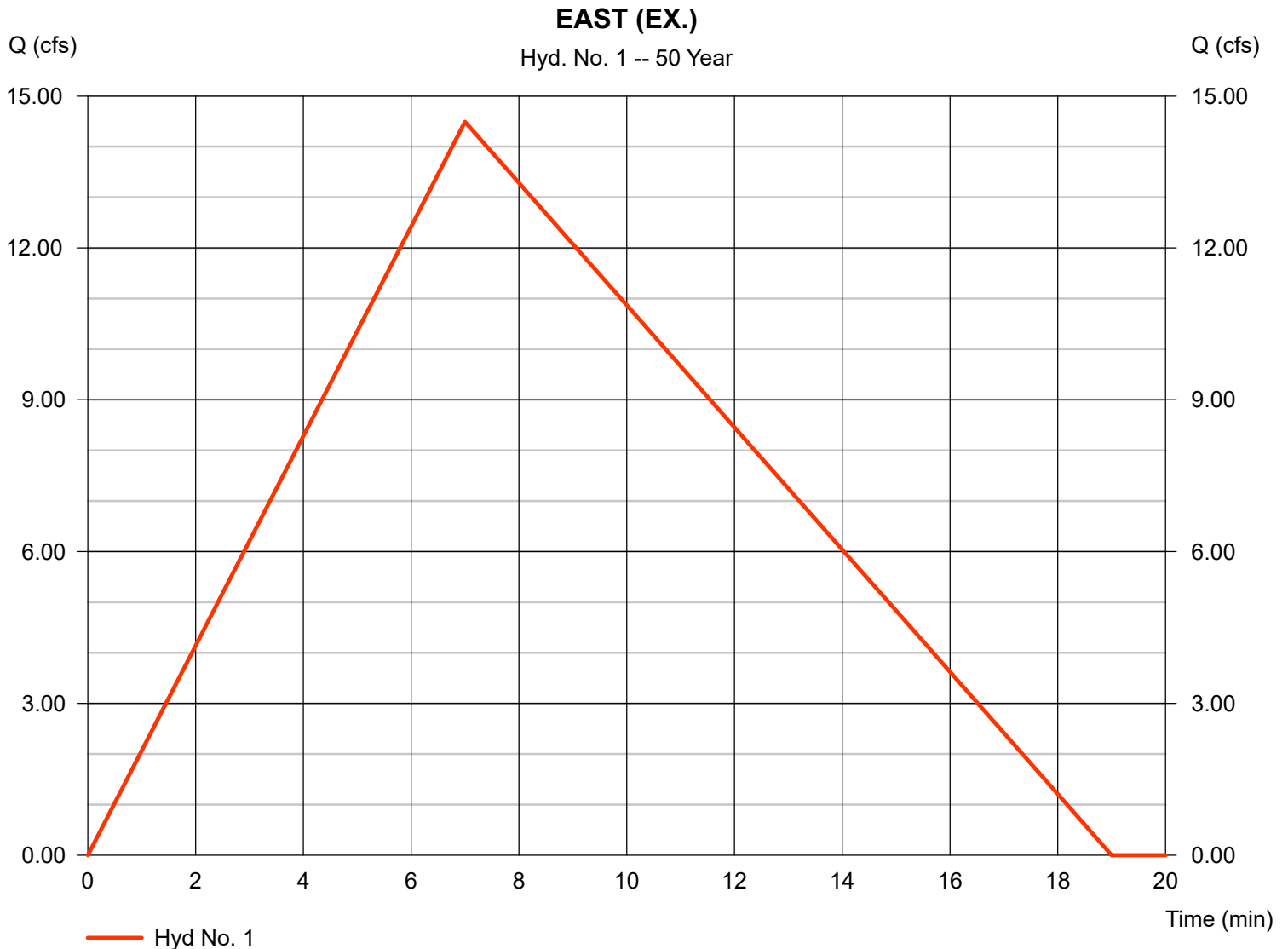

# Hydrograph Report

Hydraflow Hydrographs by Intelisolve v9.1

Friday, Dec 17, 2021

## Hyd. No. 2

WEST (EX)

Hydrograph type = Rational  
Storm frequency = 50 yrs  
Time interval = 1 min  
Drainage area = 2.630 ac  
Intensity = 7.763 in/hr  
IDF Curve = IDF CURVE.IDF

Peak discharge = 6.942 cfs  
Time to peak = 9 min  
Hyd. volume = 4,998 cuft  
Runoff coeff. = 0.34  
Tc by TR55 = 9.00 min  
Asc/Rec limb fact = 1/1.66667

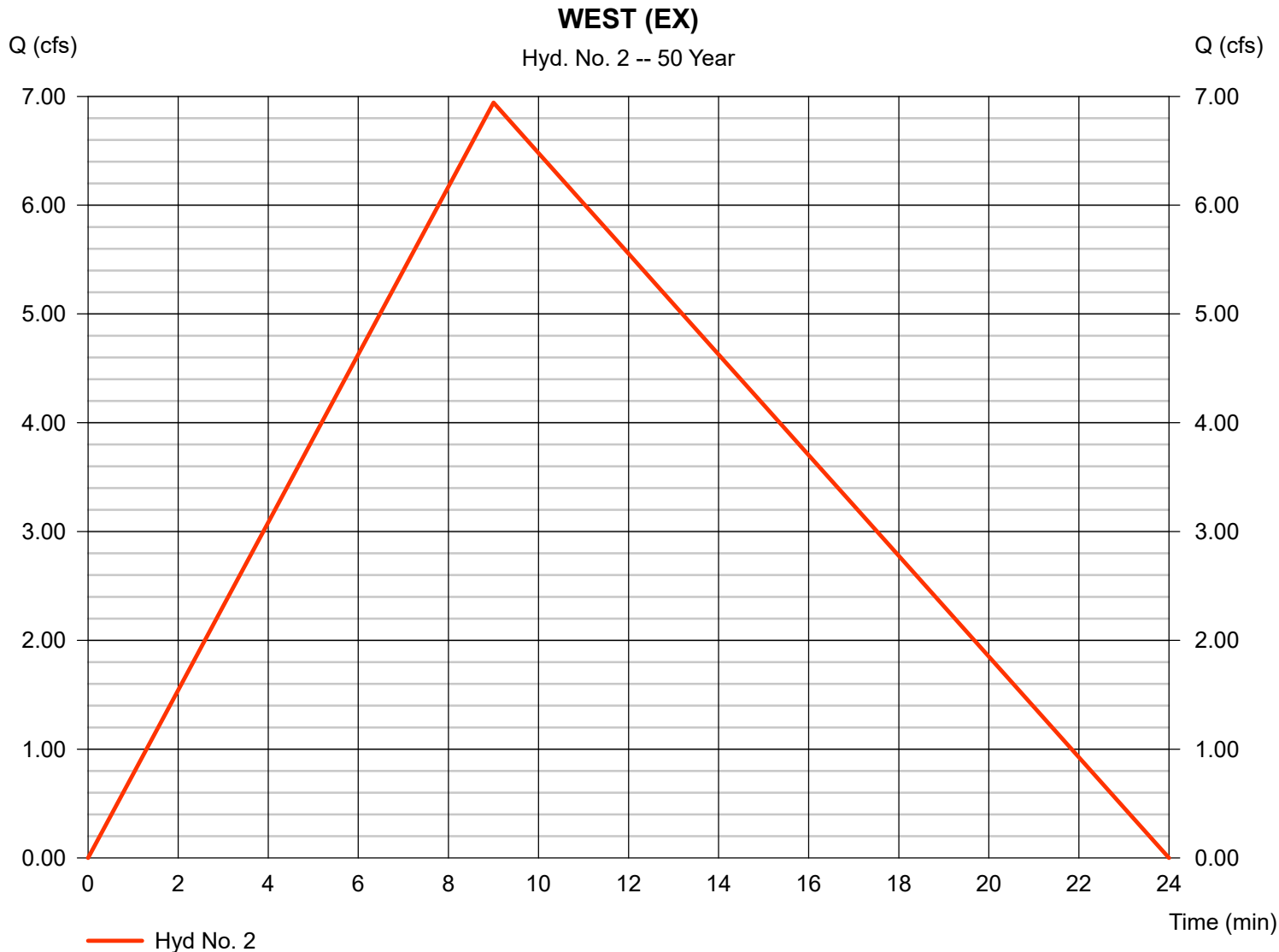



# Hydrograph Report

Hydraflow Hydrographs by Intelisolve v9.1

Friday, Dec 17, 2021

## Hyd. No. 3

EAST UNDET. (PRO.)

Hydrograph type = Rational  
 Storm frequency = 50 yrs  
 Time interval = 1 min  
 Drainage area = 2.720 ac  
 Intensity = 8.781 in/hr  
 IDF Curve = IDF CURVE.IDF

Peak discharge = 7.165 cfs  
 Time to peak = 7 min  
 Hyd. volume = 4,012 cuft  
 Runoff coeff. = 0.3  
 Tc by TR55 = 7.00 min  
 Asc/Rec limb fact = 1/1.66667

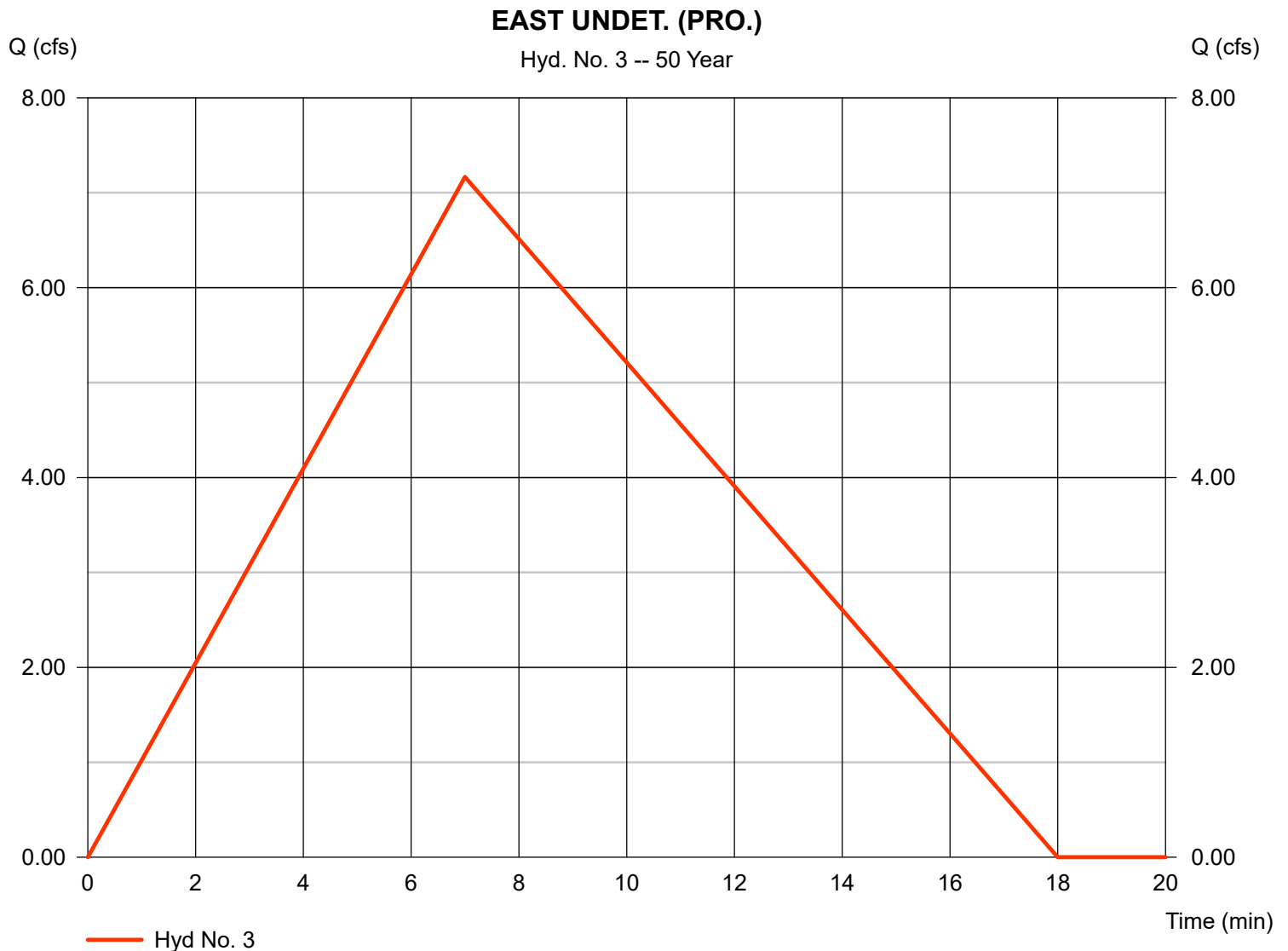

# Hydrograph Report

Hydraflow Hydrographs by Intelisolve v9.1

Friday, Dec 17, 2021

## Hyd. No. 4

EAST DET.1 (PRO.)

Hydrograph type = Rational  
 Storm frequency = 50 yrs  
 Time interval = 1 min  
 Drainage area = 1.320 ac  
 Intensity = 10.191 in/hr  
 IDF Curve = IDF CURVE.IDF

Peak discharge = 6.726 cfs  
 Time to peak = 5 min  
 Hyd. volume = 2,690 cuft  
 Runoff coeff. = 0.5  
 Tc by User = 5.00 min  
 Asc/Rec limb fact = 1/1.66667

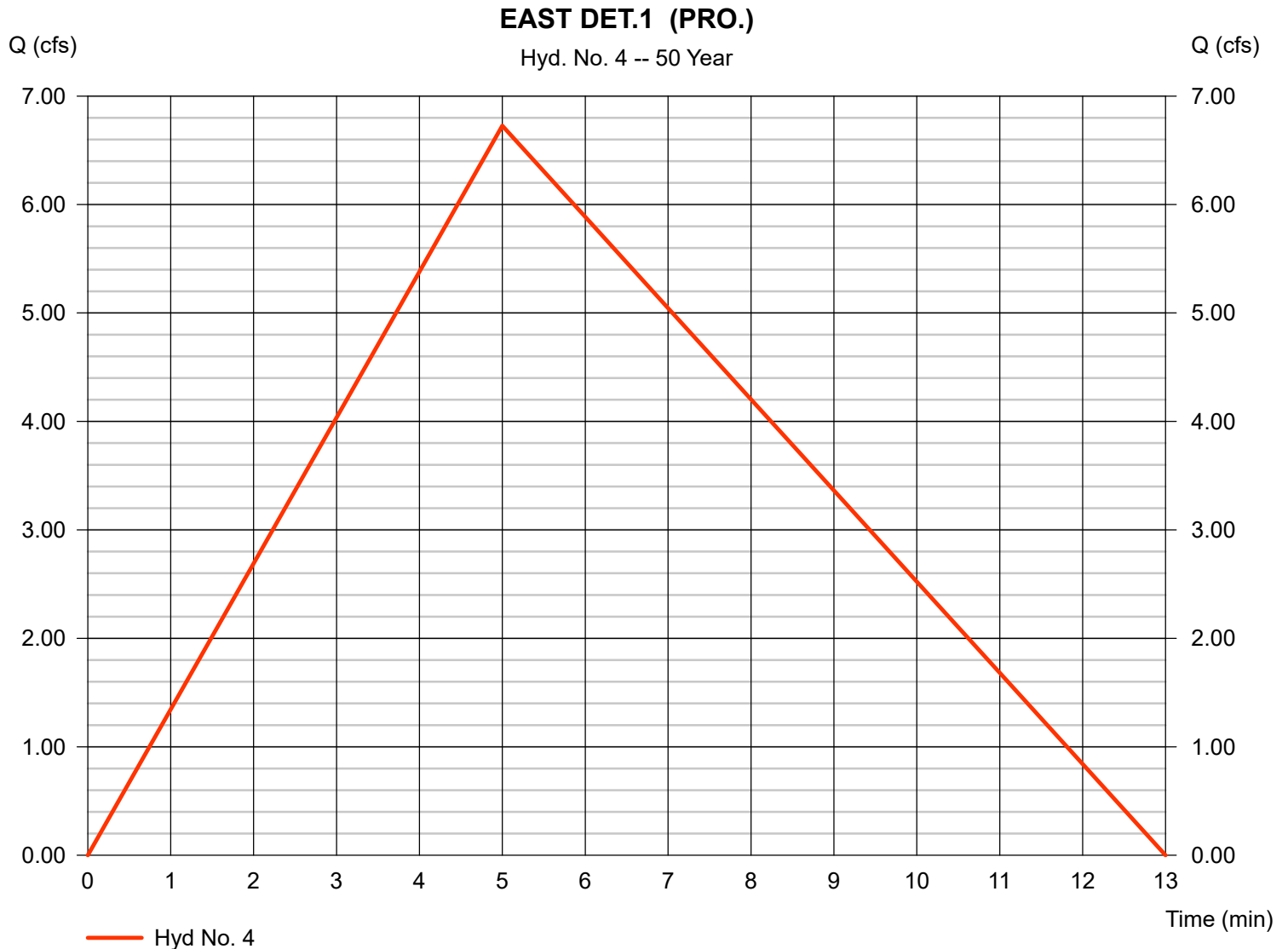

# Hydrograph Report

Hydraflow Hydrographs by Intelisolve v9.1

Friday, Dec 17, 2021

## Hyd. No. 5

EAST DET.2 (PRO.)

Hydrograph type = Rational  
 Storm frequency = 50 yrs  
 Time interval = 1 min  
 Drainage area = 0.900 ac  
 Intensity = 10.191 in/hr  
 IDF Curve = IDF CURVE.IDF

Peak discharge = 6.879 cfs  
 Time to peak = 5 min  
 Hyd. volume = 2,752 cuft  
 Runoff coeff. = 0.75  
 Tc by User = 5.00 min  
 Asc/Rec limb fact = 1/1.66667

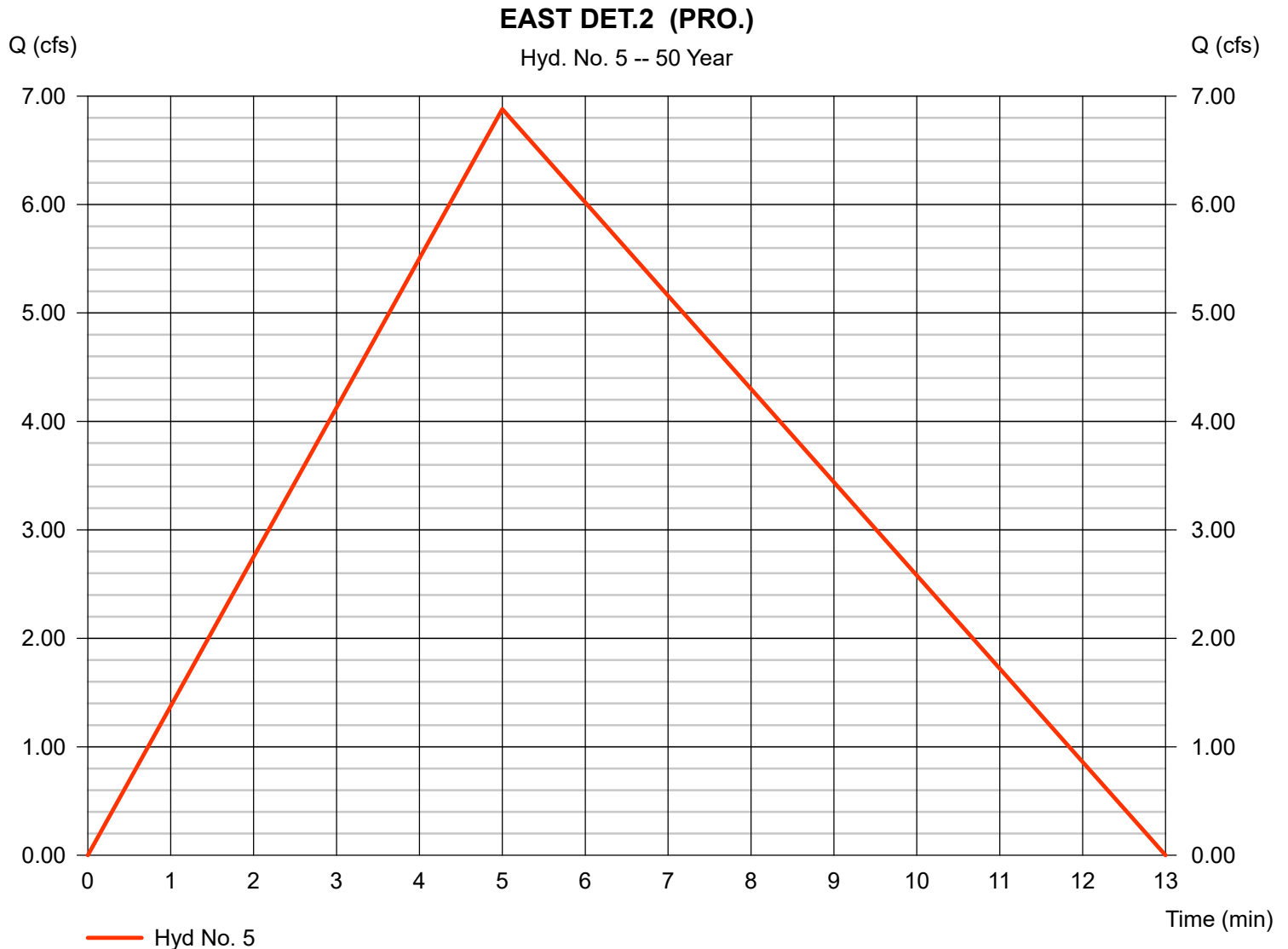

# Hydrograph Report

Hydraflow Hydrographs by Intelisolve v9.1

Friday, Dec 17, 2021

## Hyd. No. 6

Outflow (U.G. Sys. 3)

Hydrograph type	= Reservoir	Peak discharge	= 0.000 cfs
Storm frequency	= 50 yrs	Time to peak	= n/a
Time interval	= 1 min	Hyd. volume	= 0 cuft
Inflow hyd. No.	= 4 - EAST DET.1 (PRO.)	Max. Elevation	= 227.70 ft
Reservoir name	= U.G. STORAGE SYSTEM #3	Max. Storage	= 2,623 cuft

Storage Indication method used.

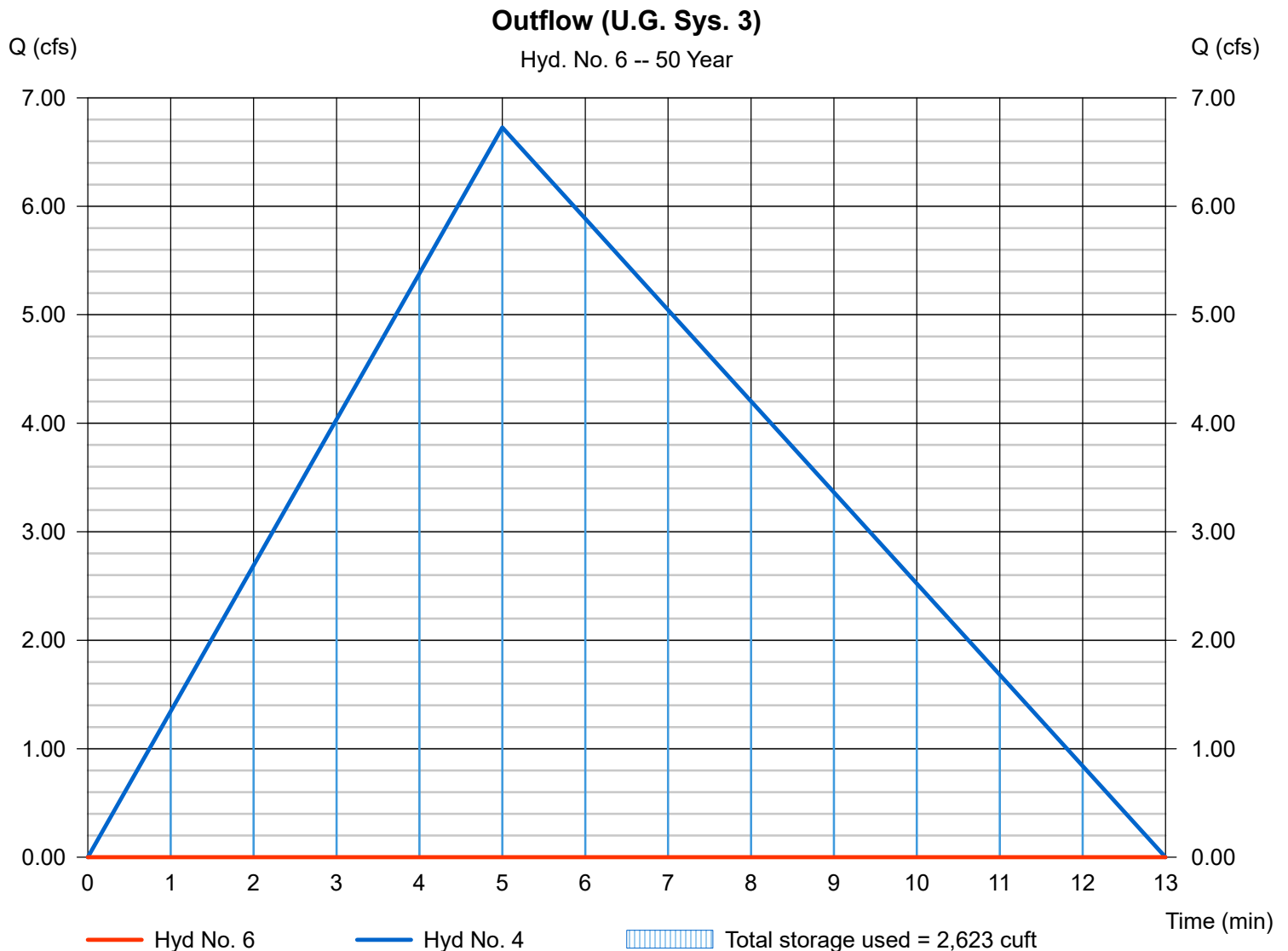

# Hydrograph Report

Hydraflow Hydrographs by Intelisolve v9.1

Friday, Dec 17, 2021

## Hyd. No. 7

Inflow (WQ Basin)

Hydrograph type = Combine  
Storm frequency = 50 yrs  
Time interval = 1 min  
Inflow hyds. = 5, 6

Peak discharge = 6.879 cfs  
Time to peak = 5 min  
Hyd. volume = 2,683 cuft  
Contrib. drain. area = 0.900 ac

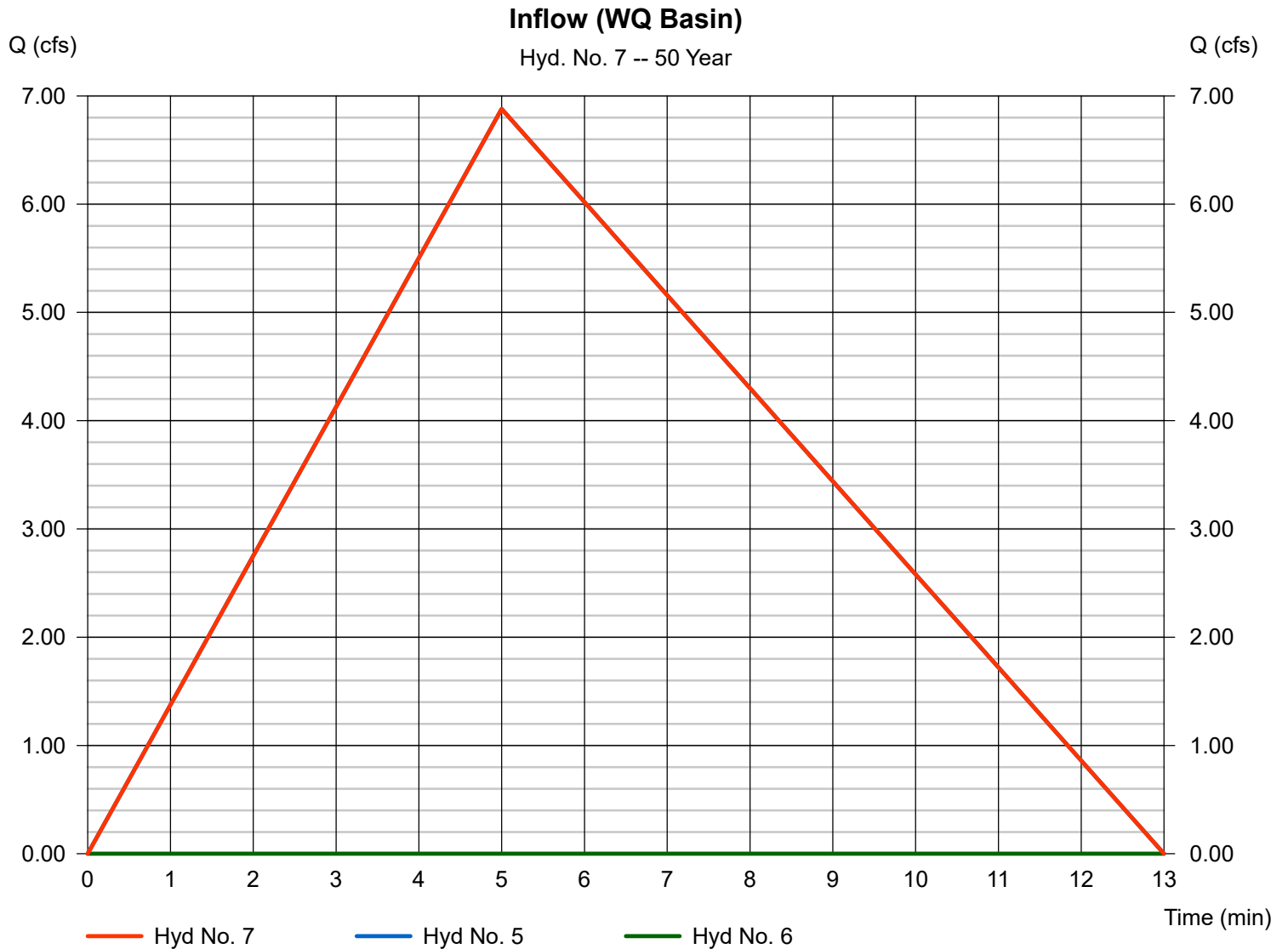

# Hydrograph Report

Hydraflow Hydrographs by Intelisolve v9.1

Friday, Dec 17, 2021

## Hyd. No. 8

Outflow (WQ Basin)

Hydrograph type = Reservoir  
 Storm frequency = 50 yrs  
 Time interval = 1 min  
 Inflow hyd. No. = 7 - Inflow (WQ Basin)  
 Reservoir name = WQ BASIN

Peak discharge = 1.098 cfs  
 Time to peak = 12 min  
 Hyd. volume = 2,129 cuft  
 Max. Elevation = 213.60 ft  
 Max. Storage = 2,241 cuft

Storage Indication method used.

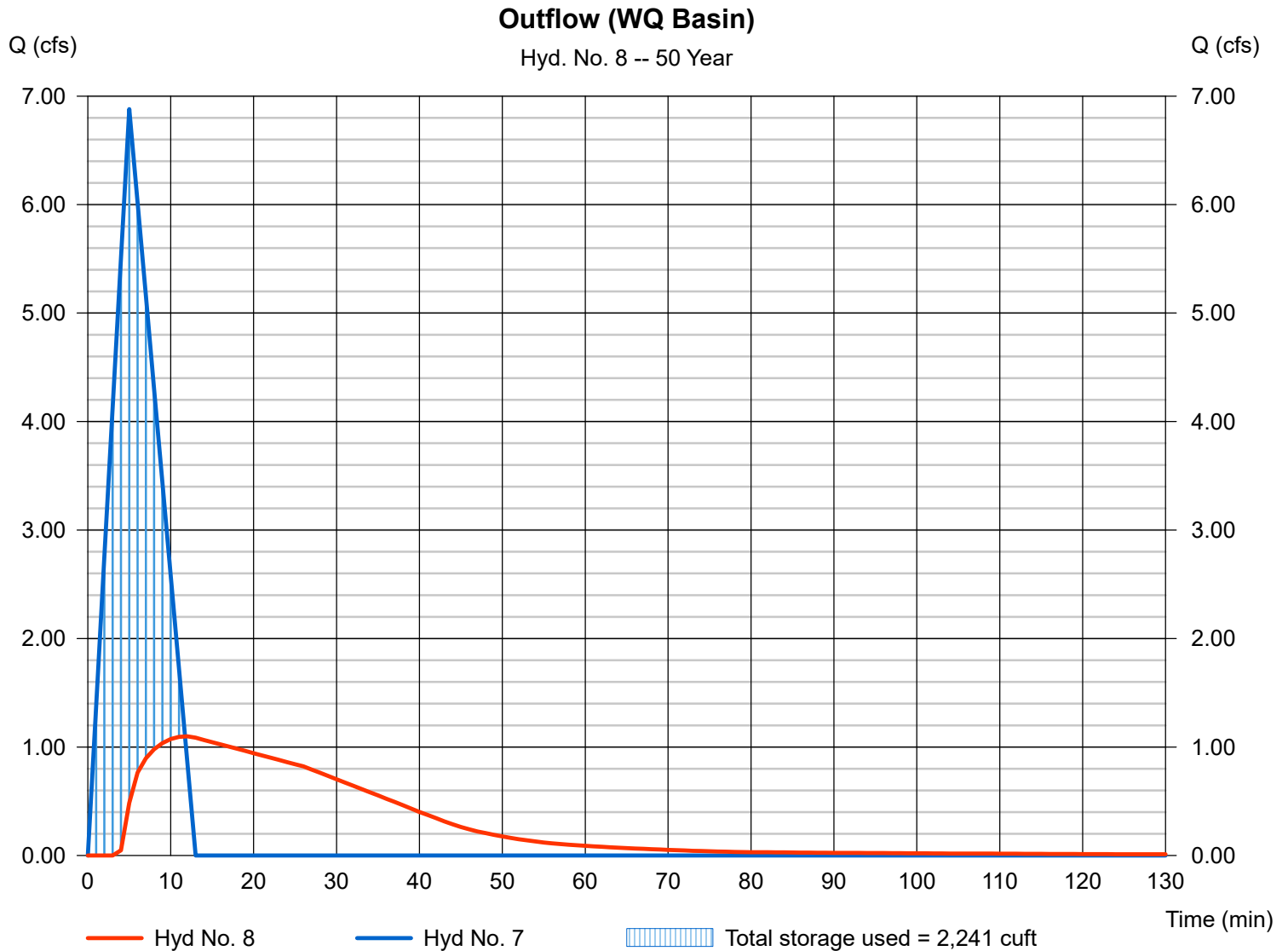

# Hydrograph Report

Hydraflow Hydrographs by Intelisolve v9.1

Friday, Dec 17, 2021

## Hyd. No. 9

TOTAL EAST (PRO)

Hydrograph type = Combine  
Storm frequency = 50 yrs  
Time interval = 1 min  
Inflow hyds. = 3, 8

Peak discharge = 8.061 cfs  
Time to peak = 7 min  
Hyd. volume = 5,998 cuft  
Contrib. drain. area = 2.720 ac

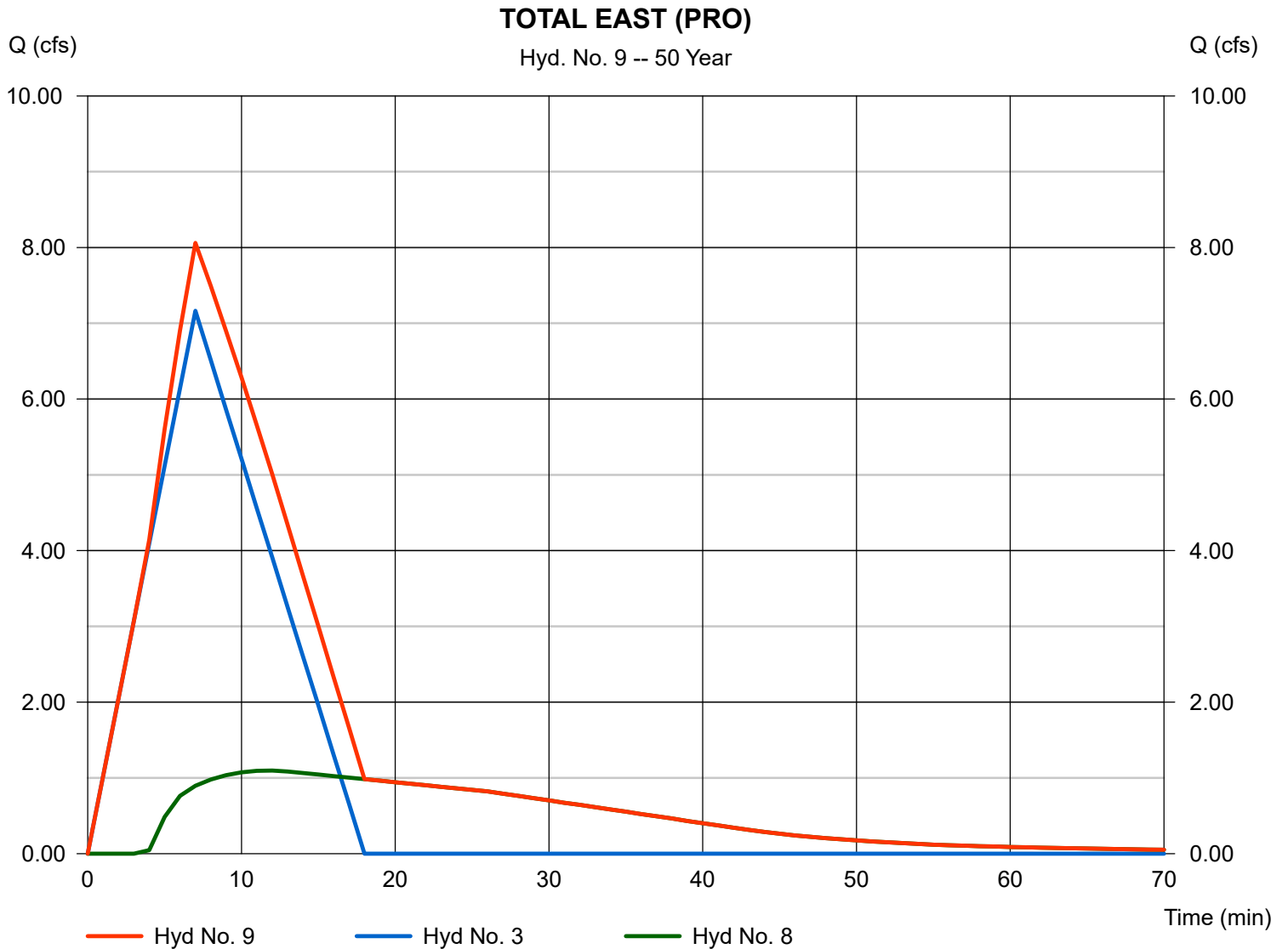

# Hydrograph Report

Hydraflow Hydrographs by Intelisolve v9.1

Friday, Dec 17, 2021

## Hyd. No. 10

WEST UNDET. (PRO.)

Hydrograph type = Rational  
Storm frequency = 50 yrs  
Time interval = 1 min  
Drainage area = 1.710 ac  
Intensity = 8.781 in/hr  
IDF Curve = IDF CURVE.IDF

Peak discharge = 5.405 cfs  
Time to peak = 7 min  
Hyd. volume = 3,027 cuft  
Runoff coeff. = 0.36  
Tc by TR55 = 7.00 min  
Asc/Rec limb fact = 1/1.66667

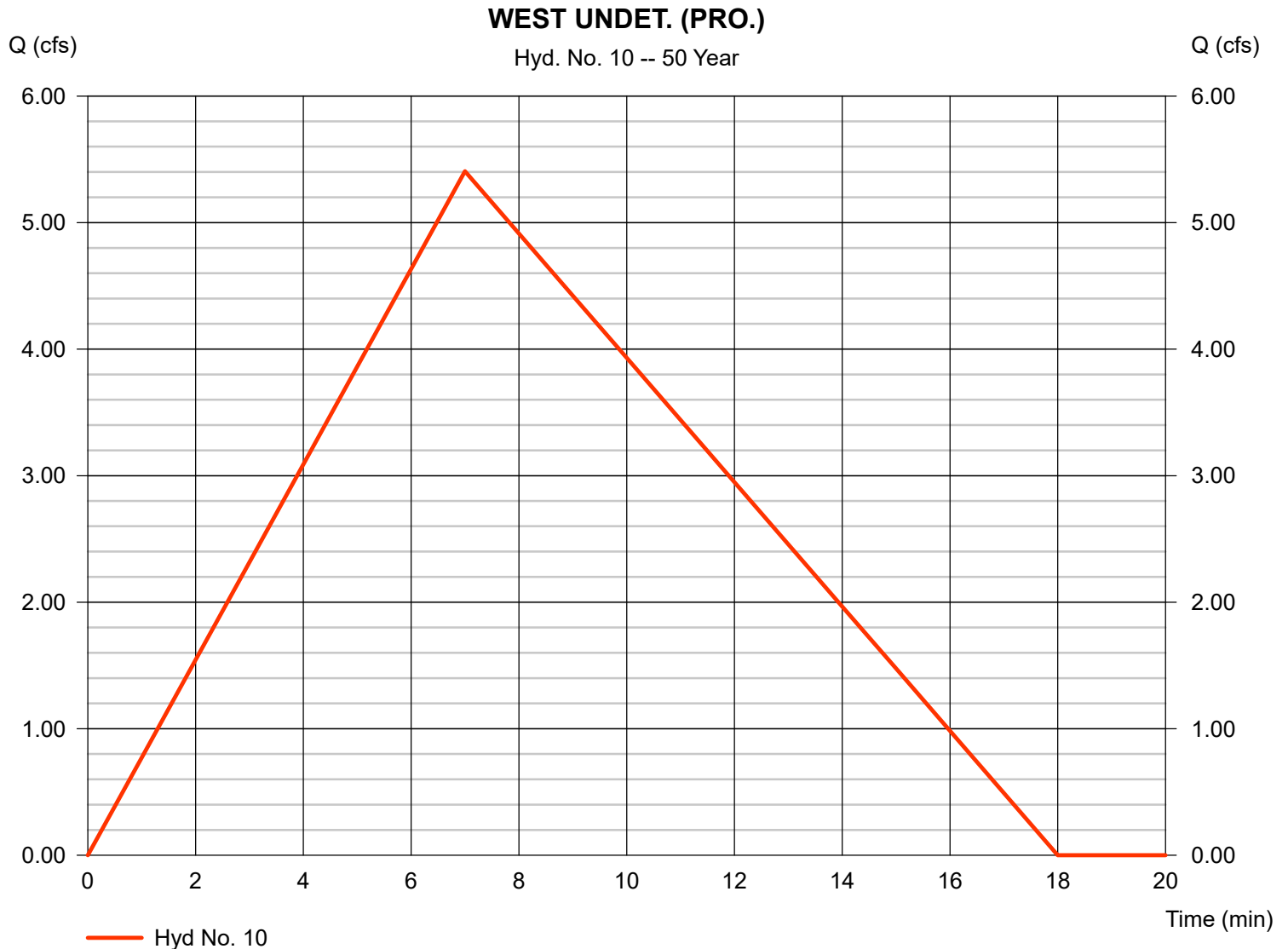



# Hydrograph Report

Hydraflow Hydrographs by Intelisolve v9.1

Friday, Dec 17, 2021

## Hyd. No. 11

WEST DET.1 (PRO.)

Hydrograph type = Rational  
 Storm frequency = 50 yrs  
 Time interval = 1 min  
 Drainage area = 0.386 ac  
 Intensity = 10.191 in/hr  
 IDF Curve = IDF CURVE.IDF

Peak discharge = 3.226 cfs  
 Time to peak = 5 min  
 Hyd. volume = 1,290 cuft  
 Runoff coeff. = 0.82  
 Tc by User = 5.00 min  
 Asc/Rec limb fact = 1/1.66667



# Hydrograph Report

Hydraflow Hydrographs by Intelisolve v9.1

Friday, Dec 17, 2021

## Hyd. No. 12

WEST DET.2 (PRO.)

Hydrograph type = Rational  
Storm frequency = 50 yrs  
Time interval = 1 min  
Drainage area = 0.702 ac  
Intensity = 10.191 in/hr  
IDF Curve = IDF CURVE.IDF

Peak discharge = 5.866 cfs  
Time to peak = 5 min  
Hyd. volume = 2,347 cuft  
Runoff coeff. = 0.82  
Tc by User = 5.00 min  
Asc/Rec limb fact = 1/1.66667

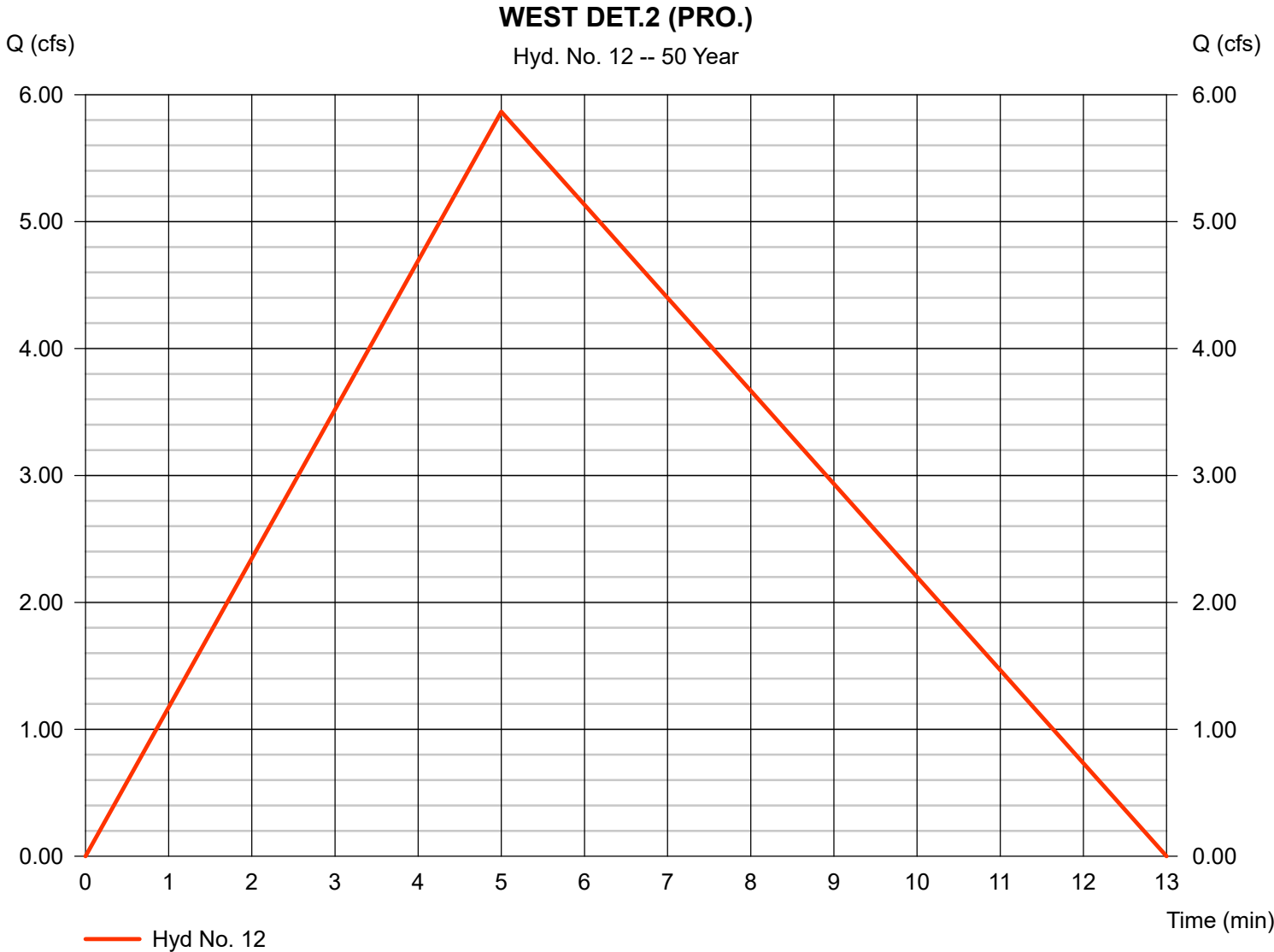

# Hydrograph Report

Hydraflow Hydrographs by Intelisolve v9.1

Friday, Dec 17, 2021

## Hyd. No. 13

Outflow (U.G. Sys. 1)

Hydrograph type	= Reservoir	Peak discharge	= 0.000 cfs
Storm frequency	= 50 yrs	Time to peak	= n/a
Time interval	= 1 min	Hyd. volume	= 0 cuft
Inflow hyd. No.	= 11 - WEST DET.1 (PRO.)	Max. Elevation	= 237.63 ft
Reservoir name	= U.G. STORAGE SYSTEM #1	Max. Storage	= 1,258 cuft

Storage Indication method used.

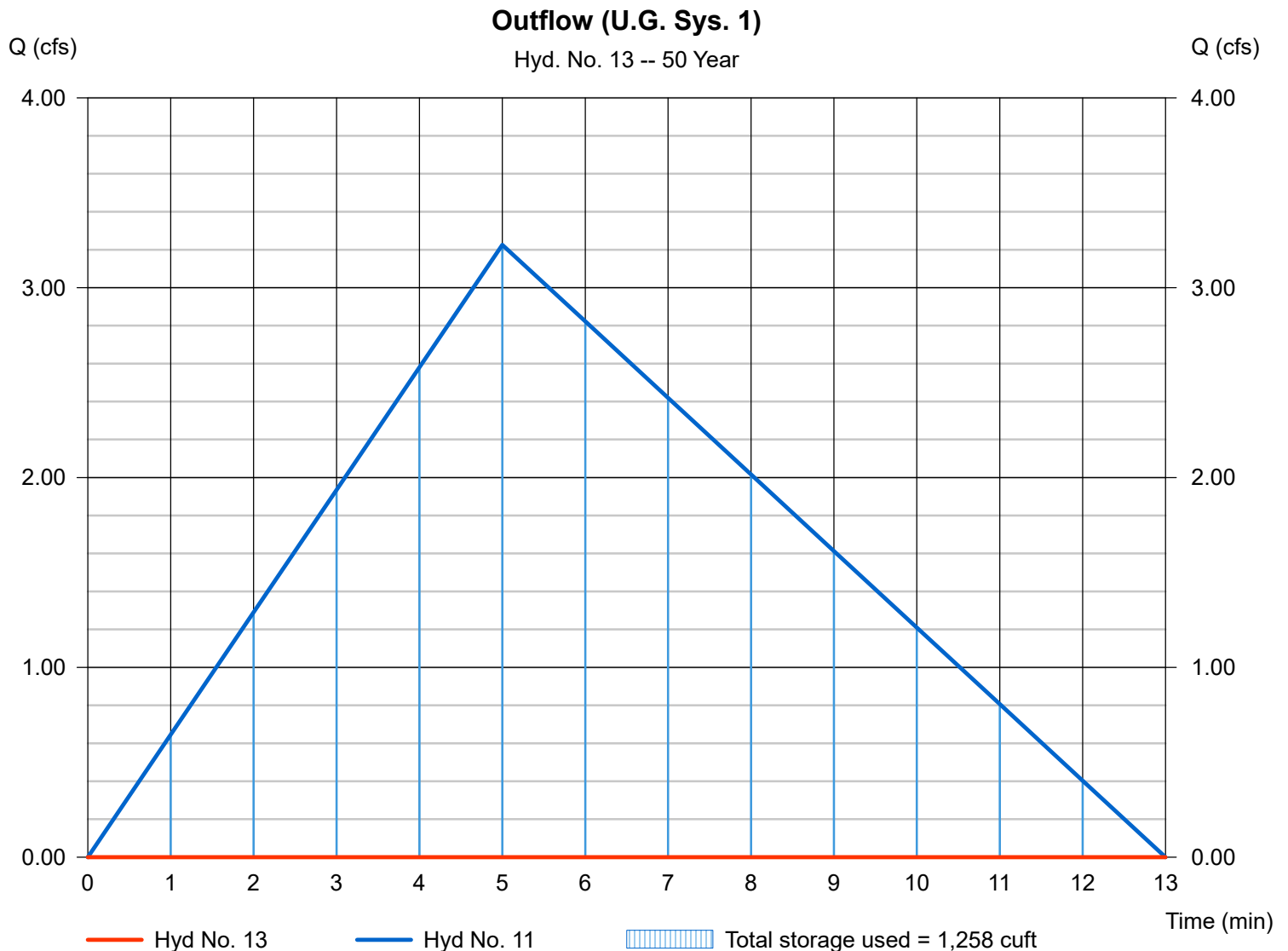

# Hydrograph Report

Hydraflow Hydrographs by Intelisolve v9.1

Friday, Dec 17, 2021

## Hyd. No. 14

Inflow (U.G. Sys. 2)

Hydrograph type = Combine  
Storm frequency = 50 yrs  
Time interval = 1 min  
Inflow hyds. = 12, 13

Peak discharge = 5.866 cfs  
Time to peak = 5 min  
Hyd. volume = 2,288 cuft  
Contrib. drain. area = 0.702 ac

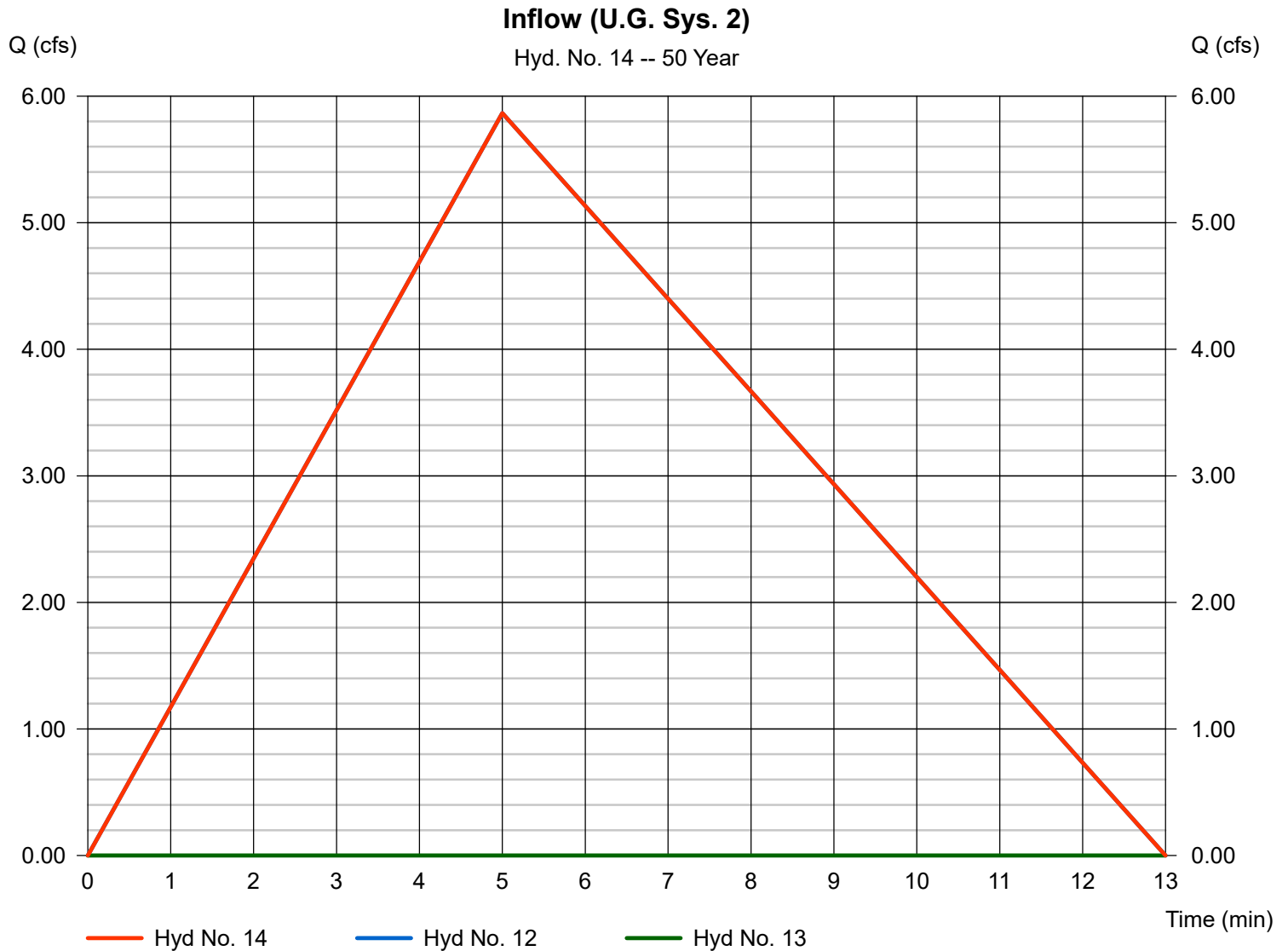

# Hydrograph Report

Hydraflow Hydrographs by Intelisolve v9.1

Friday, Dec 17, 2021

## Hyd. No. 15

Outflow (U.G. Sys. 2)

Hydrograph type	= Reservoir	Peak discharge	= 1.261 cfs
Storm frequency	= 50 yrs	Time to peak	= 11 min
Time interval	= 1 min	Hyd. volume	= 2,285 cuft
Inflow hyd. No.	= 14 - Inflow (U.G. Sys. 2)	Max. Elevation	= 231.86 ft
Reservoir name	= U.G. STORAGE SYSTEM #2	Max. Storage	= 1,686 cuft

Storage Indication method used.

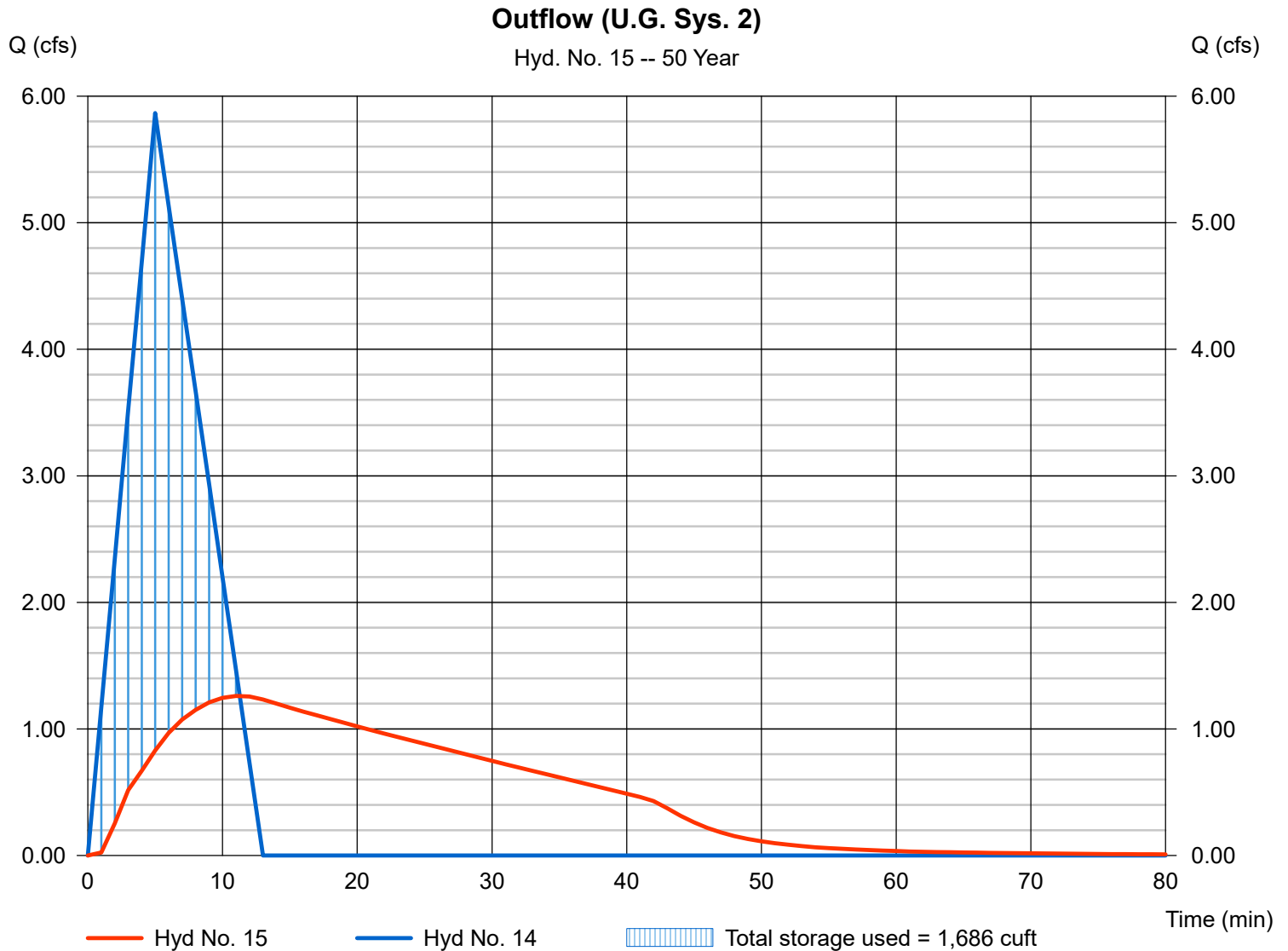

# Hydrograph Report

Hydraflow Hydrographs by Intelisolve v9.1

Friday, Dec 17, 2021

## Hyd. No. 16

TOTAL WEST (PRO)

Hydrograph type = Combine  
Storm frequency = 50 yrs  
Time interval = 1 min  
Inflow hyds. = 10, 15

Peak discharge = 6.480 cfs  
Time to peak = 7 min  
Hyd. volume = 5,204 cuft  
Contrib. drain. area = 1.710 ac

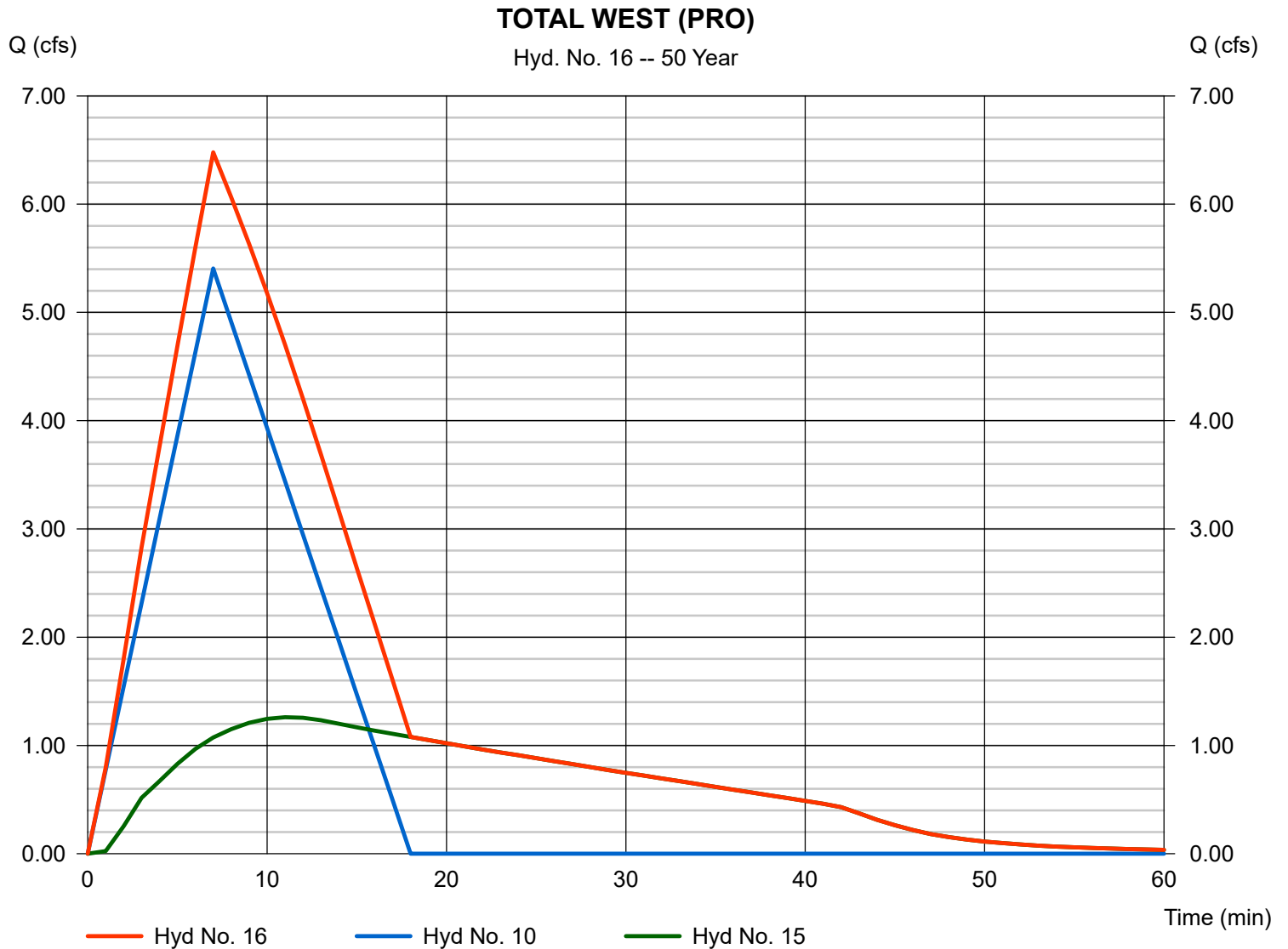

# Hydrograph Summary Report

Hydraflow Hydrographs by Intelisolve v9.1

Hyd. No.	Hydrograph type (origin)	Peak flow (cfs)	Time interval (min)	Time to peak (min)	Hyd. volume (cuft)	Inflow hyd(s)	Maximum elevation (ft)	Total strge used (cuft)	Hydrograph description	
1	Rational	16.20	1	7	9,491	---	-----	-----	EAST (EX.)	
2	Rational	7.762	1	9	5,589	---	-----	-----	WEST (EX)	
3	Rational	8.007	1	7	4,484	---	-----	-----	EAST UNDET. (PRO.)	
4	Rational	7.509	1	5	3,004	---	-----	-----	EAST DET.1 (PRO.)	
5	Rational	7.680	1	5	3,072	---	-----	-----	EAST DET.2 (PRO.)	
6	Reservoir	1.421	1	11	169	4	228.57	2,773	Outflow (U.G. Sys. 3)	
7	Combine	7.680	1	5	3,164	5, 6	-----	-----	Inflow (WQ Basin)	
8	Reservoir	1.213	1	12	2,610	7	213.92	2,636	Outflow (WQ Basin)	
9	Combine	8.972	1	7	6,934	3, 8	-----	-----	TOTAL EAST (PRO)	
10	Rational	6.041	1	7	3,383	---	-----	-----	WEST UNDET. (PRO.)	
11	Rational	3.601	1	5	1,440	---	-----	-----	WEST DET.1 (PRO.)	
12	Rational	6.549	1	5	2,620	---	-----	-----	WEST DET.2 (PRO.)	
13	Reservoir	1.231	1	12	78	11	238.53	1,350	Outflow (U.G. Sys. 1)	
14	Combine	6.549	1	5	2,632	12, 13	-----	-----	Inflow (U.G. Sys. 2)	
15	Reservoir	1.386	1	12	2,629	14	232.33	1,936	Outflow (U.G. Sys. 2)	
16	Combine	7.184	1	7	5,891	10, 15	-----	-----	TOTAL WEST (PRO)	
TAPESTRY-2021-12-17.gpw					Return Period: 100 Year			Friday, Dec 17, 2021		

# Hydrograph Report

Hydraflow Hydrographs by Intelisolve v9.1

Friday, Dec 17, 2021

## Hyd. No. 1

EAST (EX.)

Hydrograph type = Rational  
Storm frequency = 100 yrs  
Time interval = 1 min  
Drainage area = 5.110 ac  
Intensity = 9.605 in/hr  
IDF Curve = IDF CURVE.IDF

Peak discharge = 16.20 cfs  
Time to peak = 7 min  
Hyd. volume = 9,491 cuft  
Runoff coeff. = 0.33  
Tc by TR55 = 7.32 min  
Asc/Rec limb fact = 1/1.66667

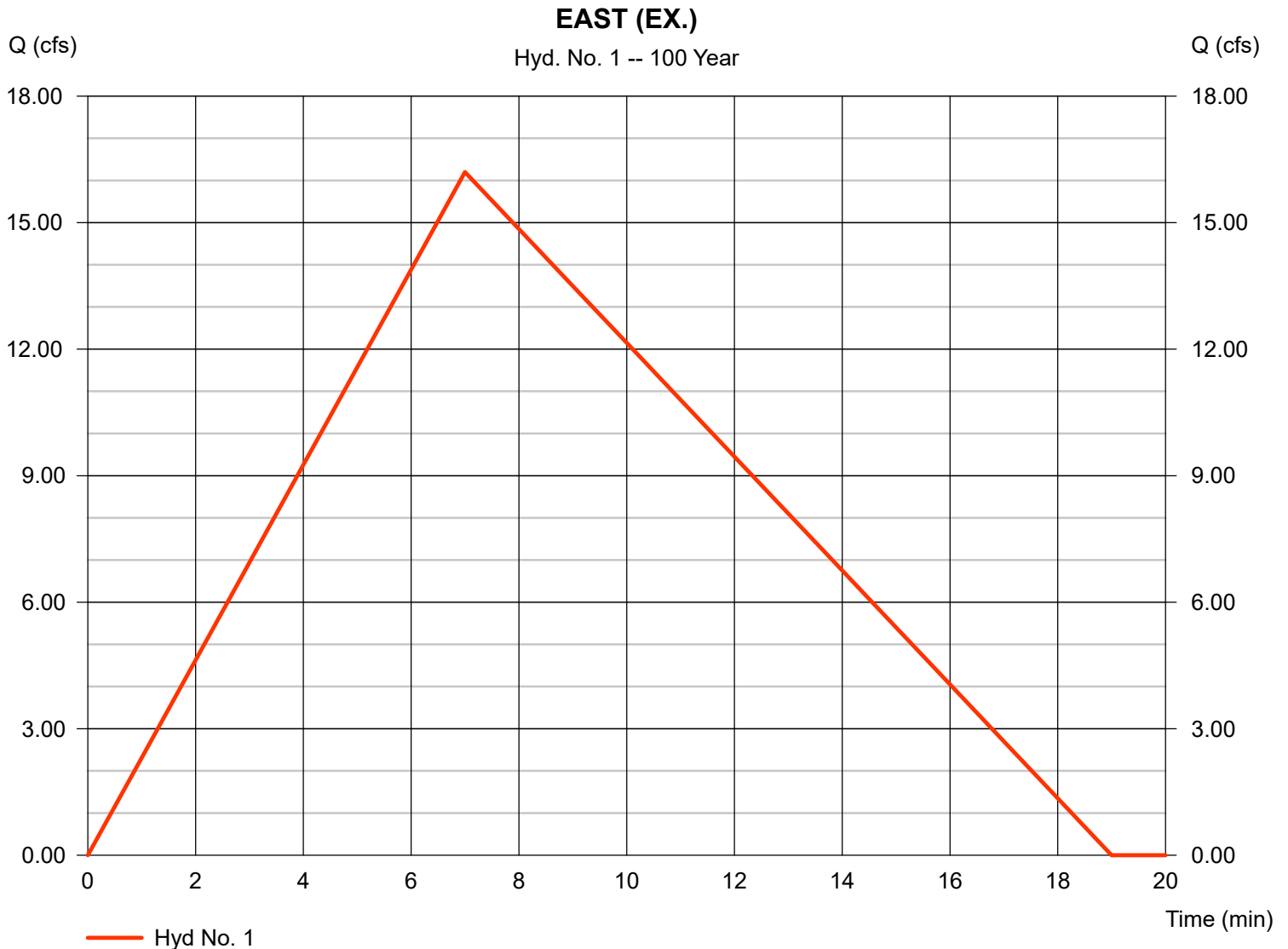



# Hydrograph Report

Hydraflow Hydrographs by Intelisolve v9.1

Friday, Dec 17, 2021

## Hyd. No. 2

WEST (EX)

Hydrograph type = Rational  
 Storm frequency = 100 yrs  
 Time interval = 1 min  
 Drainage area = 2.630 ac  
 Intensity = 8.681 in/hr  
 IDF Curve = IDF CURVE.IDF

Peak discharge = 7.762 cfs  
 Time to peak = 9 min  
 Hyd. volume = 5,589 cuft  
 Runoff coeff. = 0.34  
 Tc by TR55 = 9.00 min  
 Asc/Rec limb fact = 1/1.66667

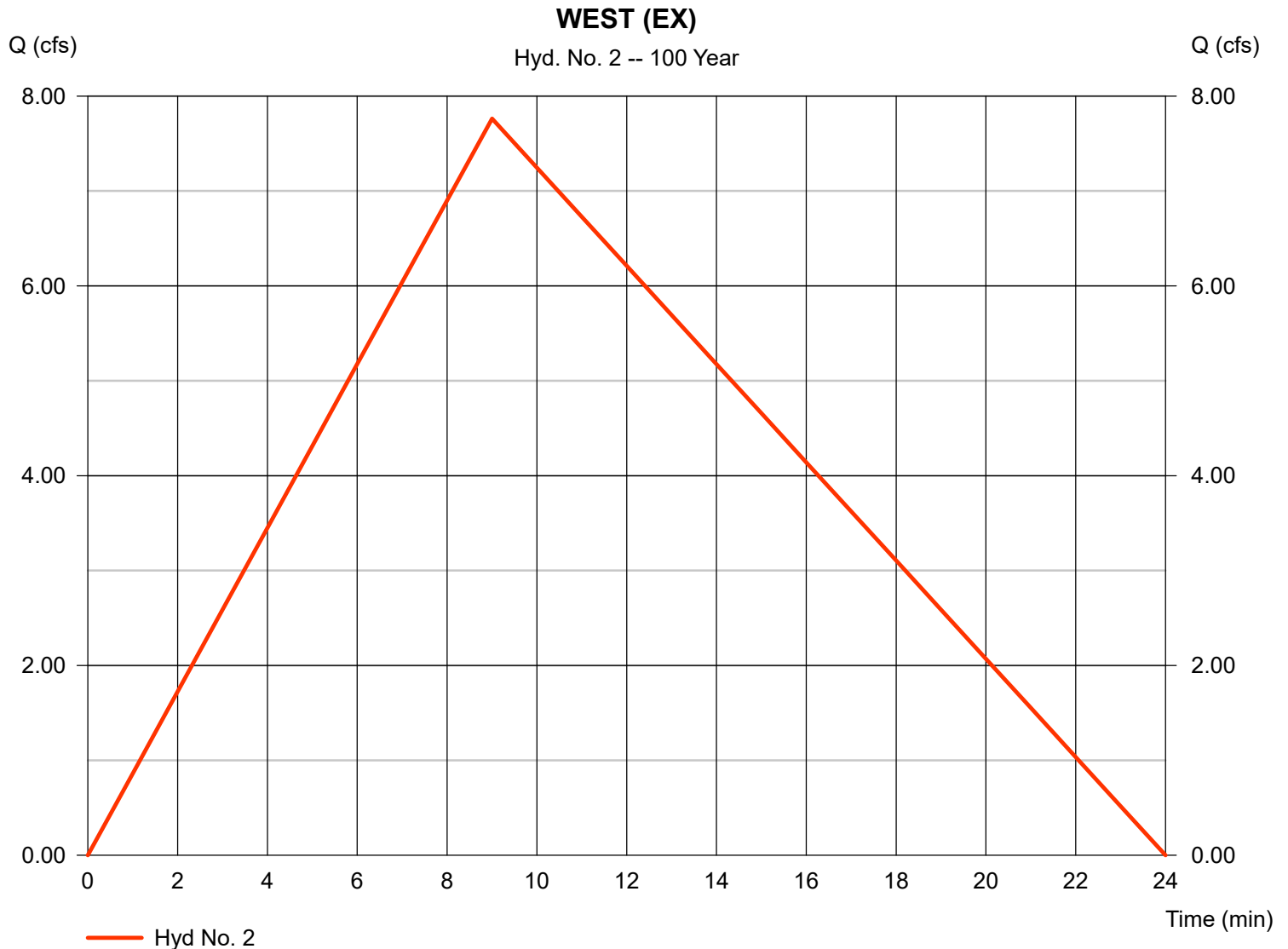

# Hydrograph Report

Hydraflow Hydrographs by Intelisolve v9.1

Friday, Dec 17, 2021

## Hyd. No. 3

EAST UNDET. (PRO.)

Hydrograph type = Rational  
 Storm frequency = 100 yrs  
 Time interval = 1 min  
 Drainage area = 2.720 ac  
 Intensity = 9.813 in/hr  
 IDF Curve = IDF CURVE.IDF

Peak discharge = 8.007 cfs  
 Time to peak = 7 min  
 Hyd. volume = 4,484 cuft  
 Runoff coeff. = 0.3  
 Tc by TR55 = 7.00 min  
 Asc/Rec limb fact = 1/1.66667

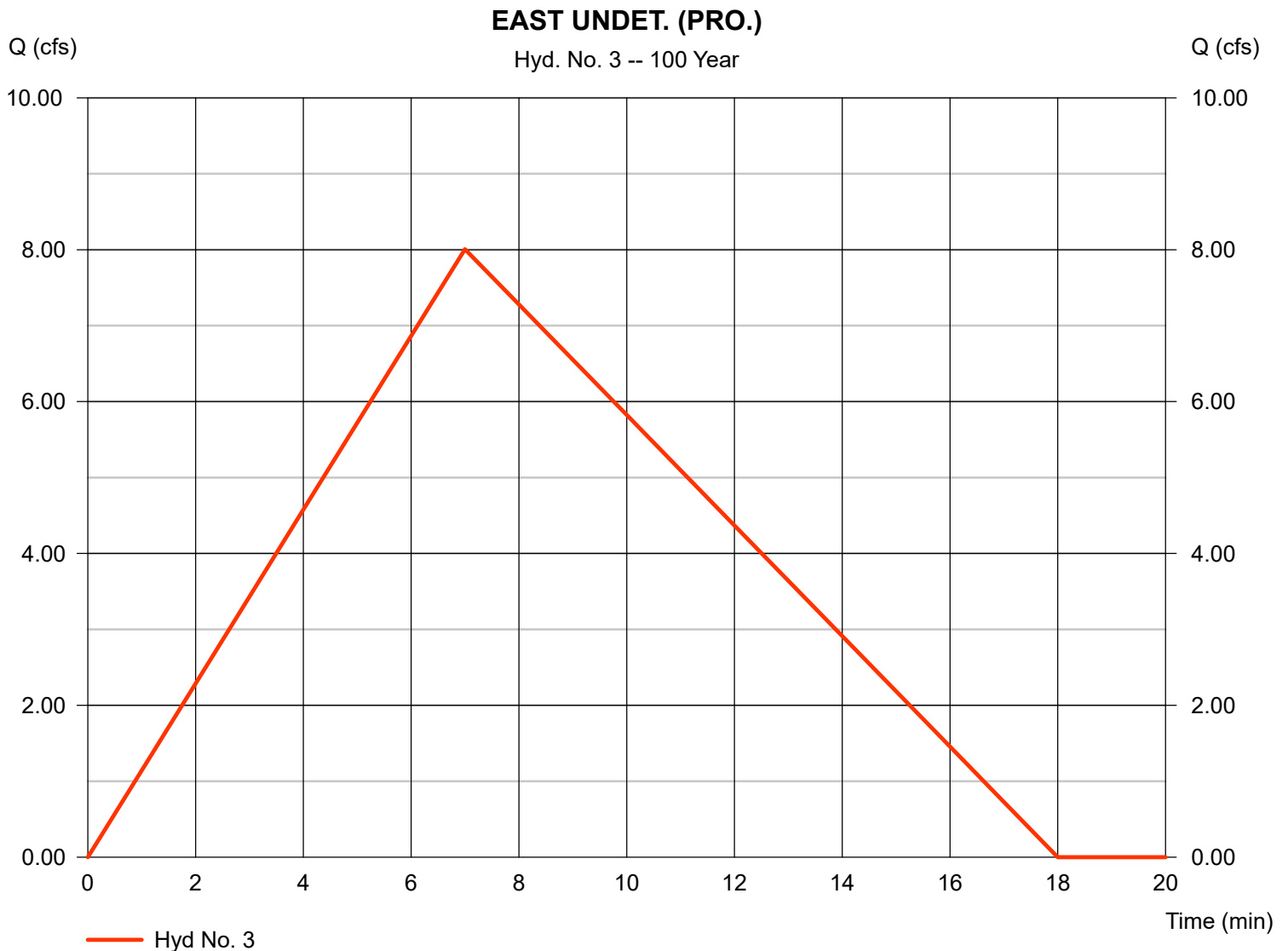

# Hydrograph Report

## Hyd. No. 4

EAST DET.1 (PRO.)

Hydrograph type = Rational  
Storm frequency = 100 yrs  
Time interval = 1 min  
Drainage area = 1.320 ac  
Intensity = 11.377 in/hr  
IDF Curve = IDF CURVE.IDF

Peak discharge = 7.509 cfs  
Time to peak = 5 min  
Hyd. volume = 3,004 cuft  
Runoff coeff. = 0.5  
Tc by User = 5.00 min  
Asc/Rec limb fact = 1/1.66667

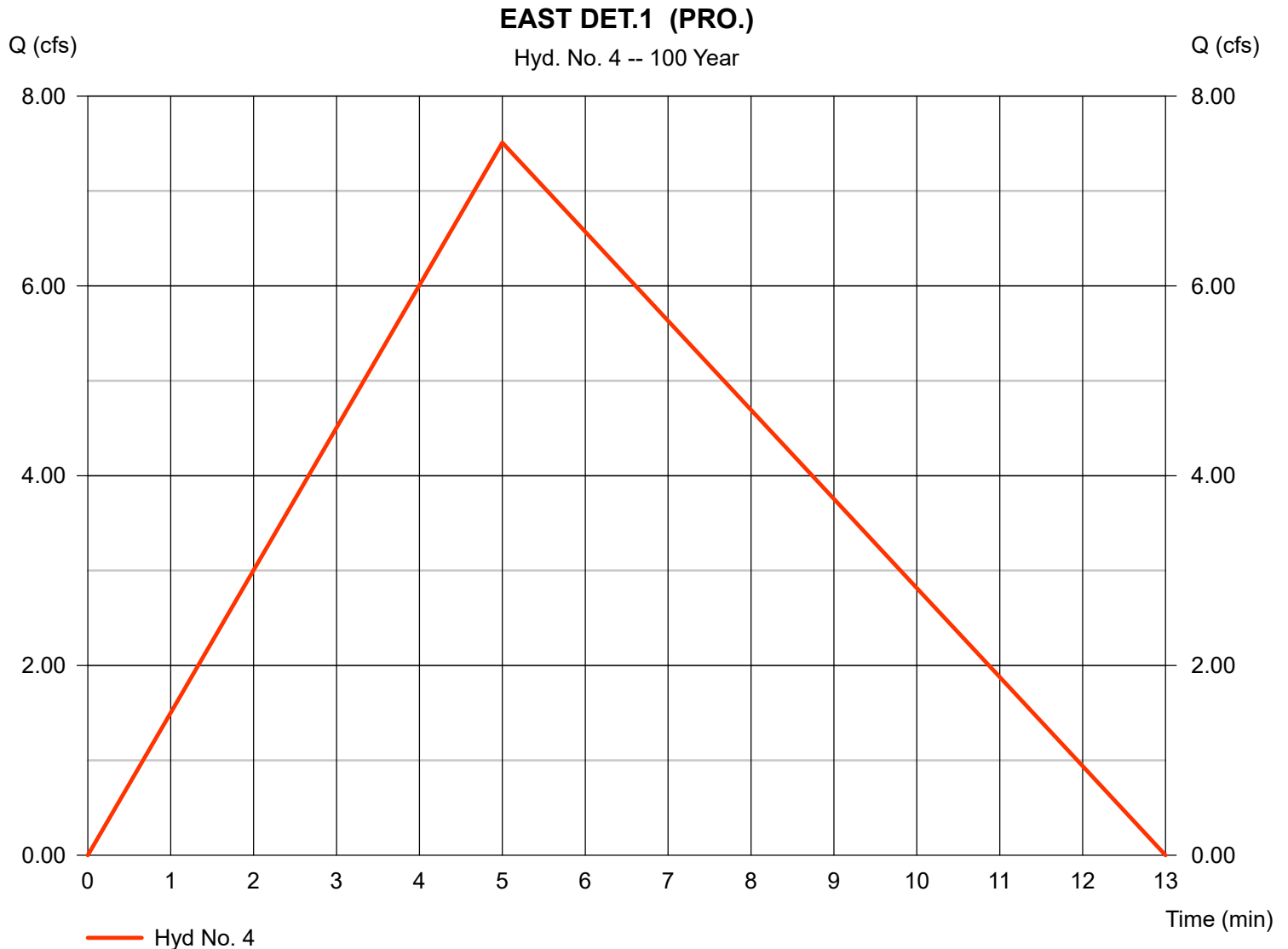

# Hydrograph Report

## Hyd. No. 5

EAST DET.2 (PRO.)

Hydrograph type = Rational  
Storm frequency = 100 yrs  
Time interval = 1 min  
Drainage area = 0.900 ac  
Intensity = 11.377 in/hr  
IDF Curve = IDF CURVE.IDF

Peak discharge = 7.680 cfs  
Time to peak = 5 min  
Hyd. volume = 3,072 cuft  
Runoff coeff. = 0.75  
Tc by User = 5.00 min  
Asc/Rec limb fact = 1/1.66667

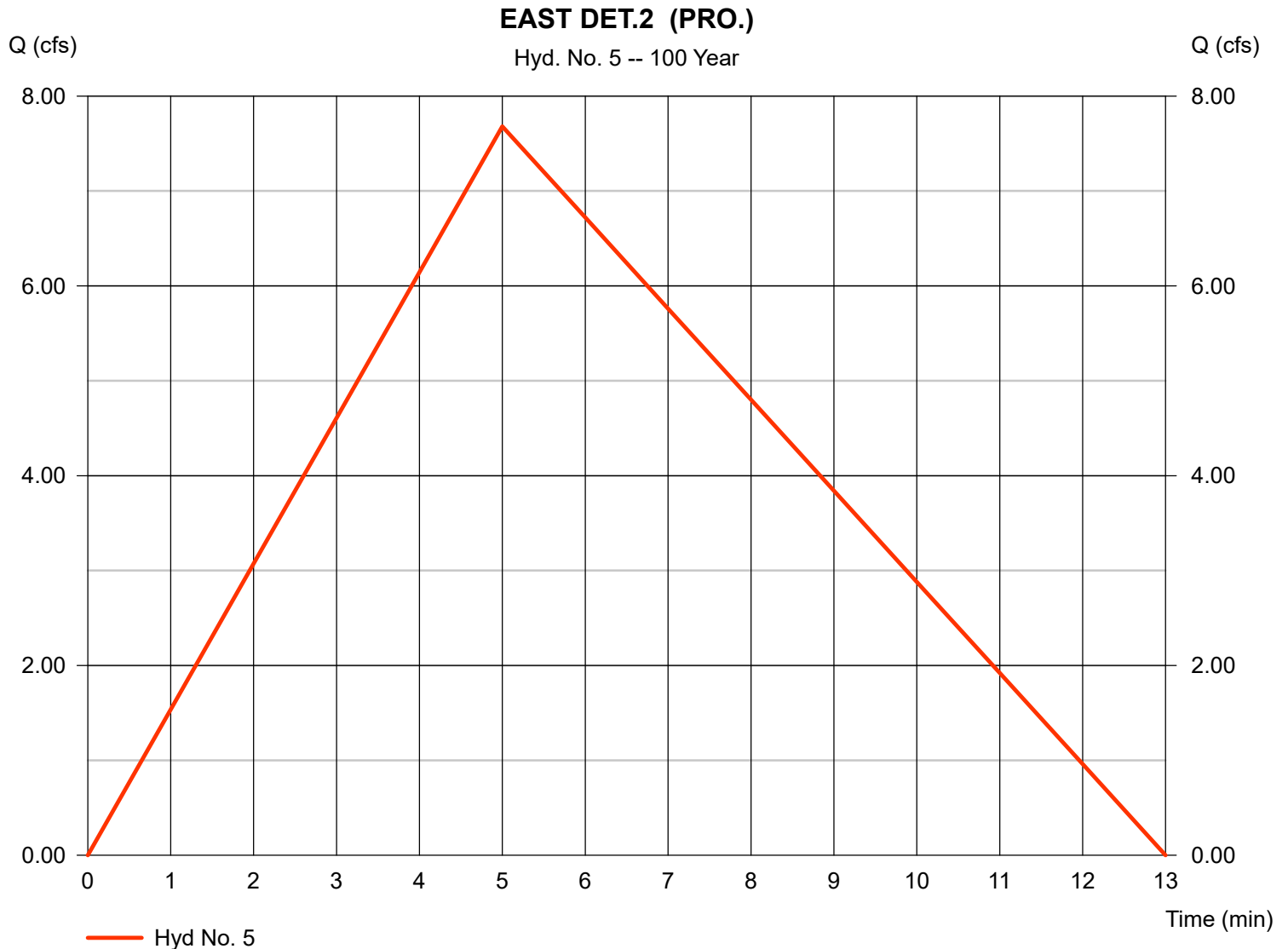

# Hydrograph Report

Hydraflow Hydrographs by Intelisolve v9.1

Friday, Dec 17, 2021

## Hyd. No. 6

Outflow (U.G. Sys. 3)

Hydrograph type	= Reservoir	Peak discharge	= 1.421 cfs
Storm frequency	= 100 yrs	Time to peak	= 11 min
Time interval	= 1 min	Hyd. volume	= 169 cuft
Inflow hyd. No.	= 4 - EAST DET.1 (PRO.)	Max. Elevation	= 228.57 ft
Reservoir name	= U.G. STORAGE SYSTEM #3	Max. Storage	= 2,773 cuft

Storage Indication method used.

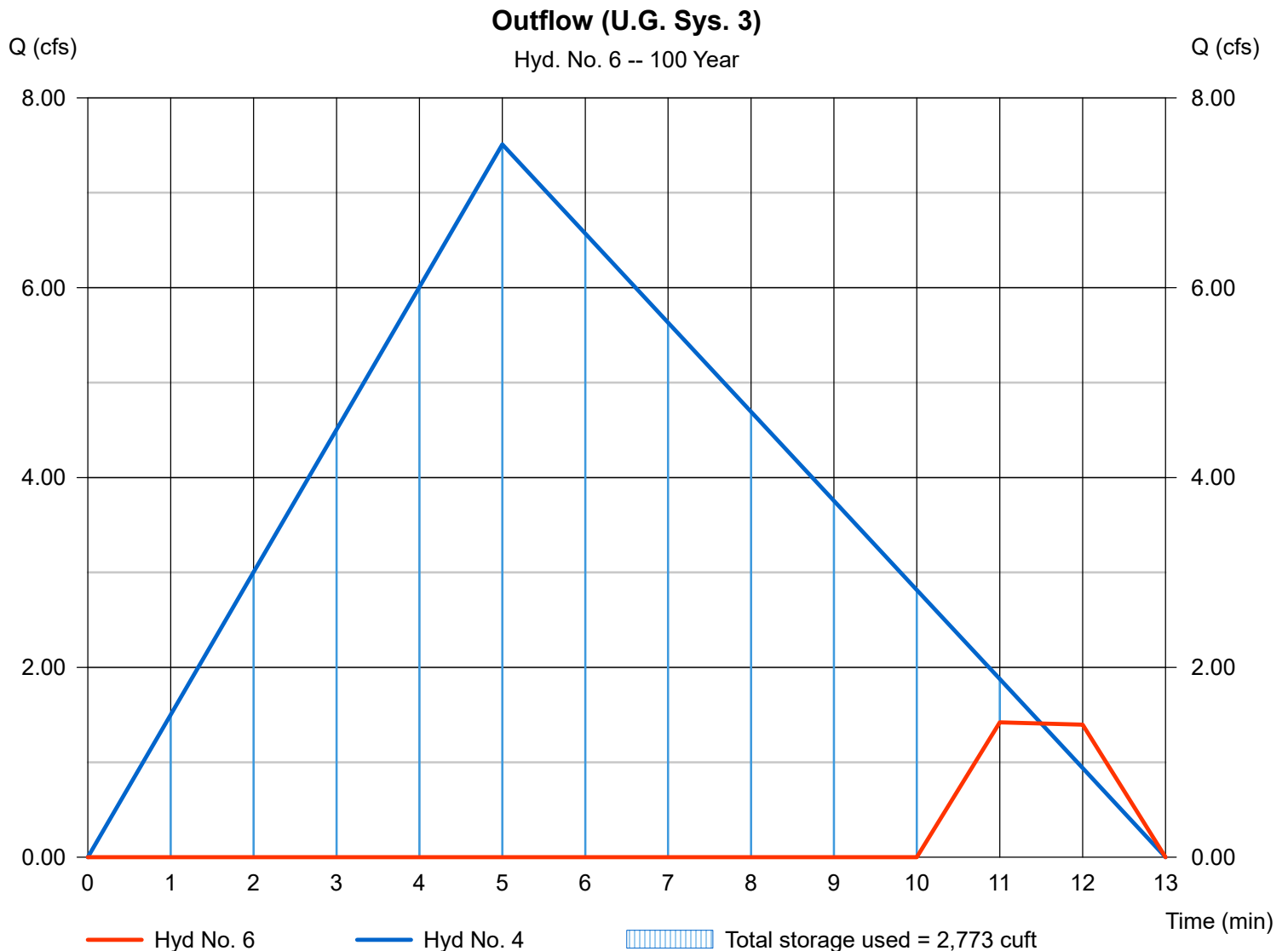

# Hydrograph Report

Hydraflow Hydrographs by Intelisolve v9.1

Friday, Dec 17, 2021

## Hyd. No. 7

Inflow (WQ Basin)

Hydrograph type = Combine  
 Storm frequency = 100 yrs  
 Time interval = 1 min  
 Inflow hyds. = 5, 6

Peak discharge = 7.680 cfs  
 Time to peak = 5 min  
 Hyd. volume = 3,164 cuft  
 Contrib. drain. area = 0.900 ac

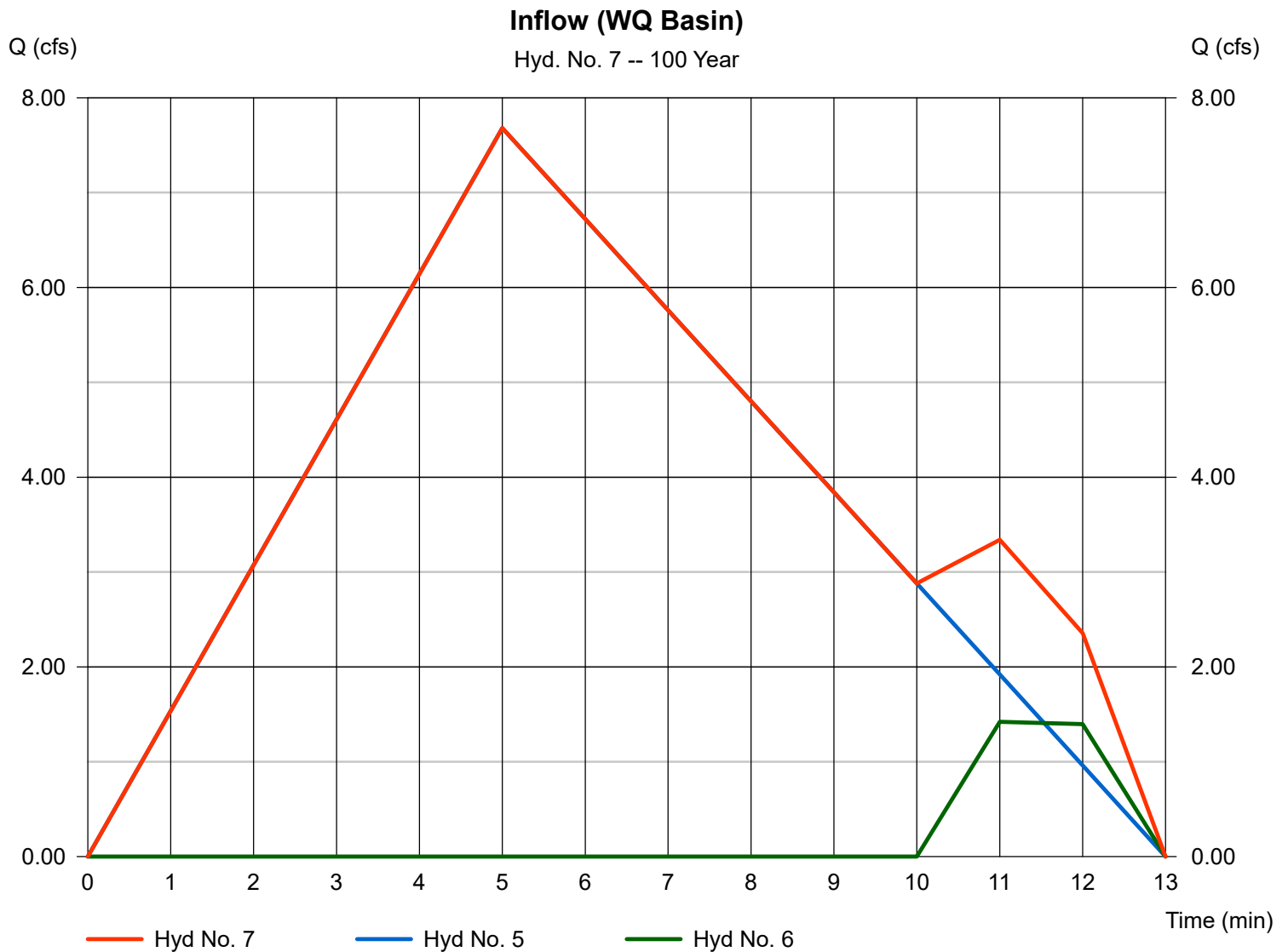

# Hydrograph Report

Hydraflow Hydrographs by Intelisolve v9.1

Friday, Dec 17, 2021

## Hyd. No. 8

Outflow (WQ Basin)

Hydrograph type	= Reservoir	Peak discharge	= 1.213 cfs
Storm frequency	= 100 yrs	Time to peak	= 12 min
Time interval	= 1 min	Hyd. volume	= 2,610 cuft
Inflow hyd. No.	= 7 - Inflow (WQ Basin)	Max. Elevation	= 213.92 ft
Reservoir name	= WQ BASIN	Max. Storage	= 2,636 cuft

Storage Indication method used.

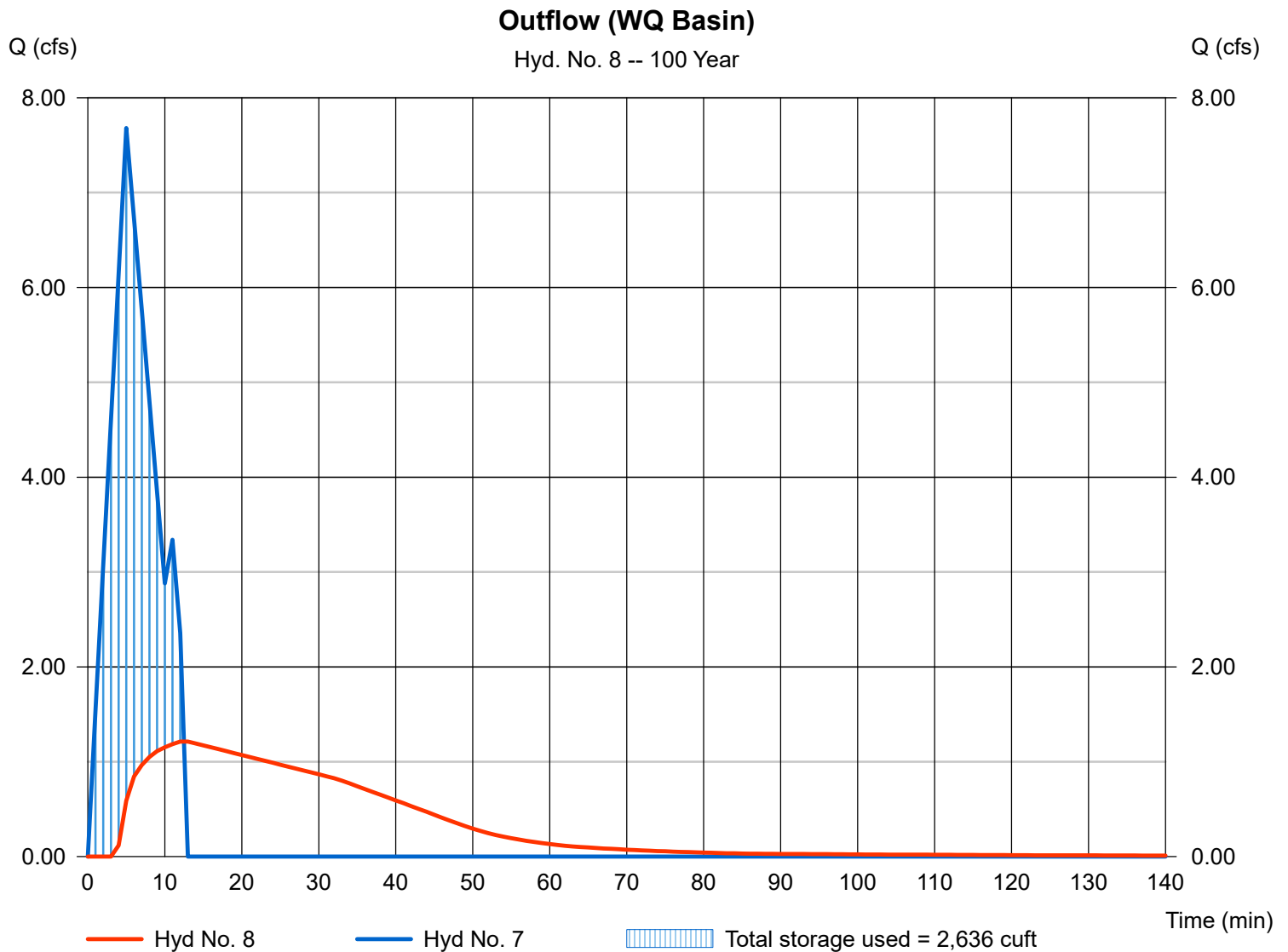

# Hydrograph Report

Hydraflow Hydrographs by Intelisolve v9.1

Friday, Dec 17, 2021

## Hyd. No. 9

TOTAL EAST (PRO)

Hydrograph type = Combine  
 Storm frequency = 100 yrs  
 Time interval = 1 min  
 Inflow hyds. = 3, 8

Peak discharge = 8.972 cfs  
 Time to peak = 7 min  
 Hyd. volume = 6,934 cuft  
 Contrib. drain. area = 2.720 ac

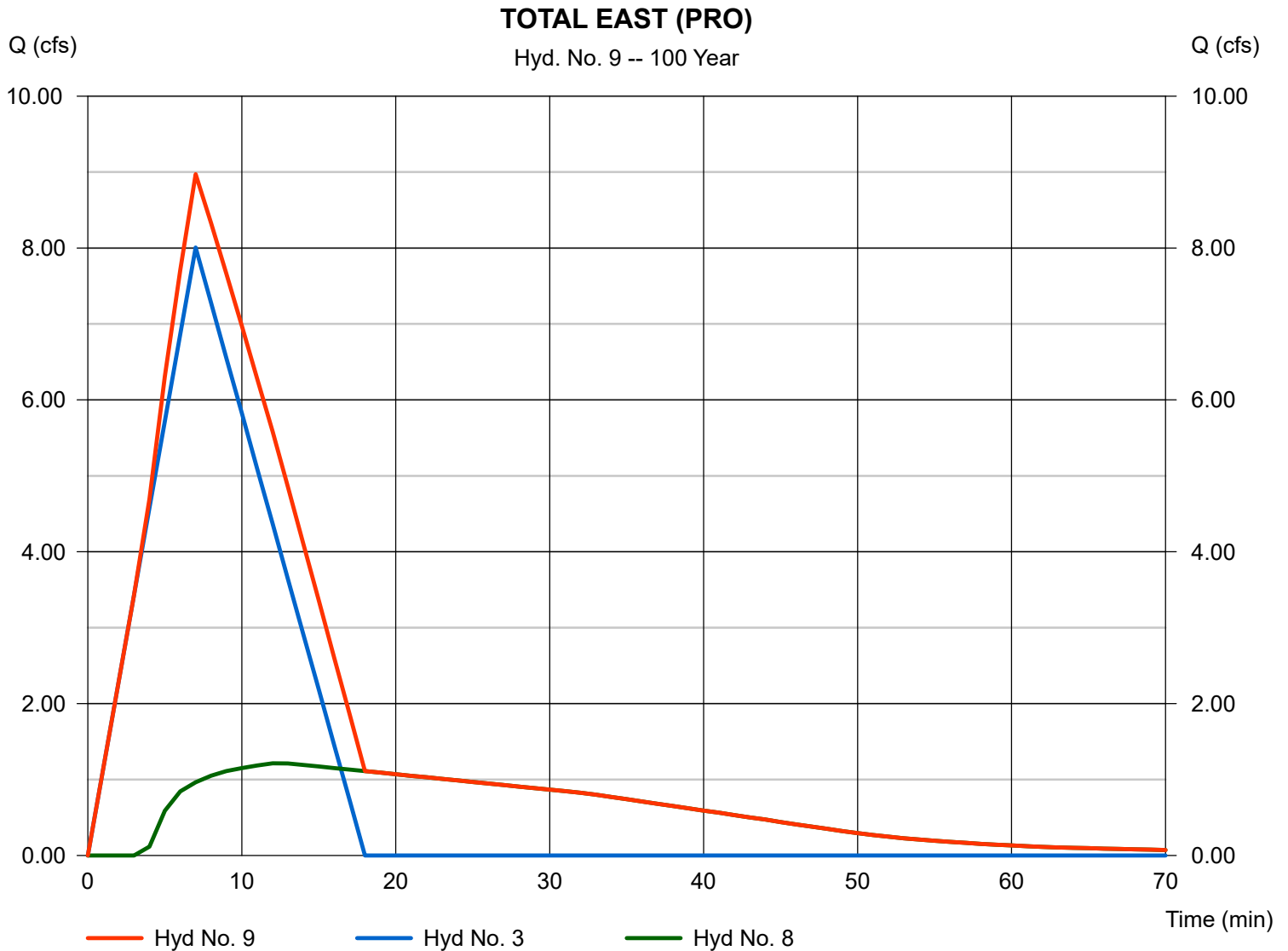



# Hydrograph Report

Hydraflow Hydrographs by Intelisolve v9.1

Friday, Dec 17, 2021

## Hyd. No. 10

WEST UNDET. (PRO.)

Hydrograph type = Rational  
 Storm frequency = 100 yrs  
 Time interval = 1 min  
 Drainage area = 1.710 ac  
 Intensity = 9.813 in/hr  
 IDF Curve = IDF CURVE.IDF

Peak discharge = 6.041 cfs  
 Time to peak = 7 min  
 Hyd. volume = 3,383 cuft  
 Runoff coeff. = 0.36  
 Tc by TR55 = 7.00 min  
 Asc/Rec limb fact = 1/1.66667

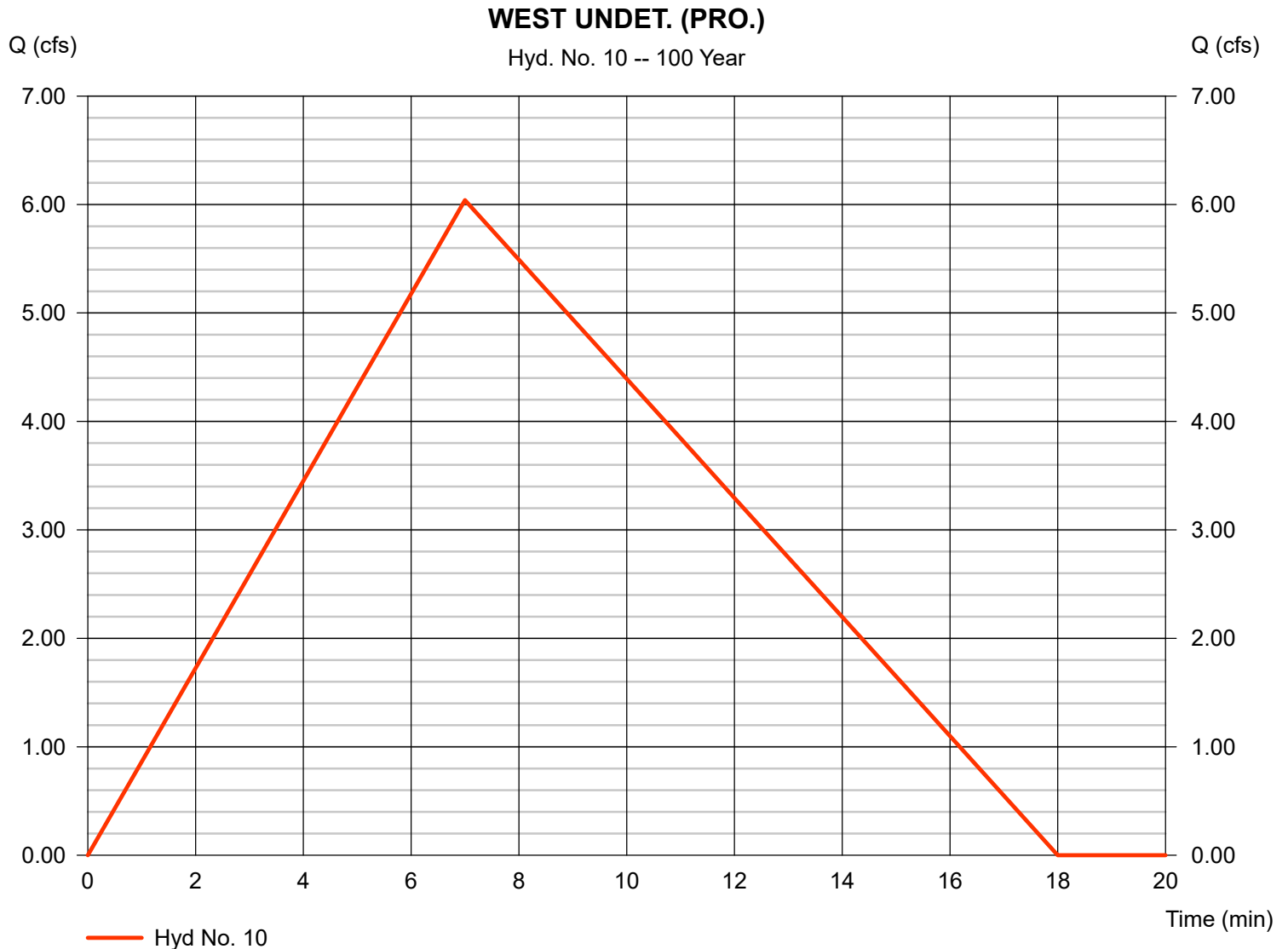

# Hydrograph Report

Hydraflow Hydrographs by Intelisolve v9.1

Friday, Dec 17, 2021

## Hyd. No. 11

WEST DET.1 (PRO.)

Hydrograph type = Rational  
 Storm frequency = 100 yrs  
 Time interval = 1 min  
 Drainage area = 0.386 ac  
 Intensity = 11.377 in/hr  
 IDF Curve = IDF CURVE.IDF

Peak discharge = 3.601 cfs  
 Time to peak = 5 min  
 Hyd. volume = 1,440 cuft  
 Runoff coeff. = 0.82  
 Tc by User = 5.00 min  
 Asc/Rec limb fact = 1/1.66667



# Hydrograph Report

Hydraflow Hydrographs by Intelisolve v9.1

Friday, Dec 17, 2021

## Hyd. No. 12

WEST DET.2 (PRO.)

Hydrograph type = Rational  
 Storm frequency = 100 yrs  
 Time interval = 1 min  
 Drainage area = 0.702 ac  
 Intensity = 11.377 in/hr  
 IDF Curve = IDF CURVE.IDF

Peak discharge = 6.549 cfs  
 Time to peak = 5 min  
 Hyd. volume = 2,620 cuft  
 Runoff coeff. = 0.82  
 Tc by User = 5.00 min  
 Asc/Rec limb fact = 1/1.66667

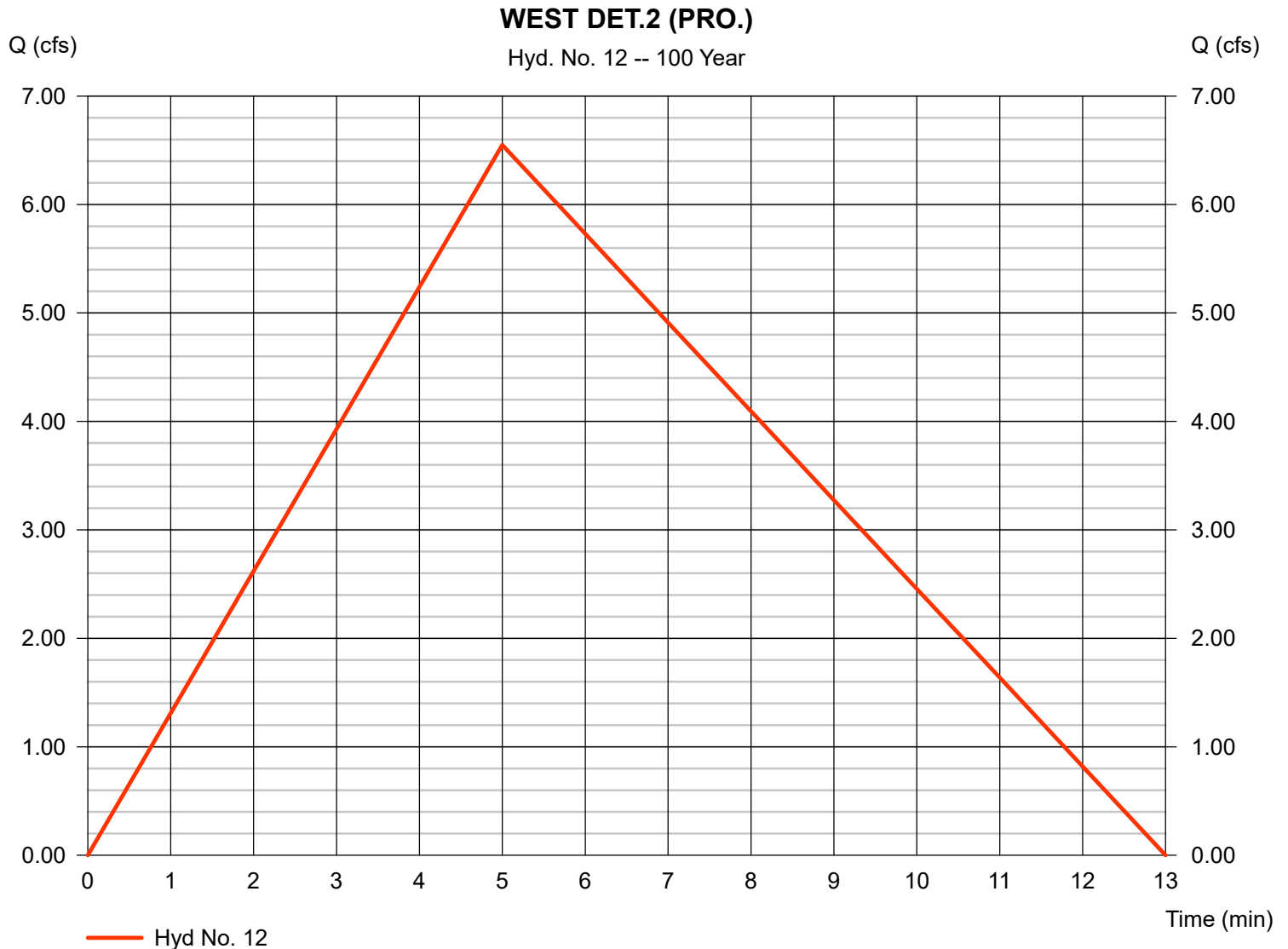

# Hydrograph Report

Hydraflow Hydrographs by Intelisolve v9.1

Friday, Dec 17, 2021

## Hyd. No. 13

Outflow (U.G. Sys. 1)

Hydrograph type	= Reservoir	Peak discharge	= 1.231 cfs
Storm frequency	= 100 yrs	Time to peak	= 12 min
Time interval	= 1 min	Hyd. volume	= 78 cuft
Inflow hyd. No.	= 11 - WEST DET.1 (PRO.)	Max. Elevation	= 238.53 ft
Reservoir name	= U.G. STORAGE SYSTEM #1	Max. Storage	= 1,350 cuft

Storage Indication method used.

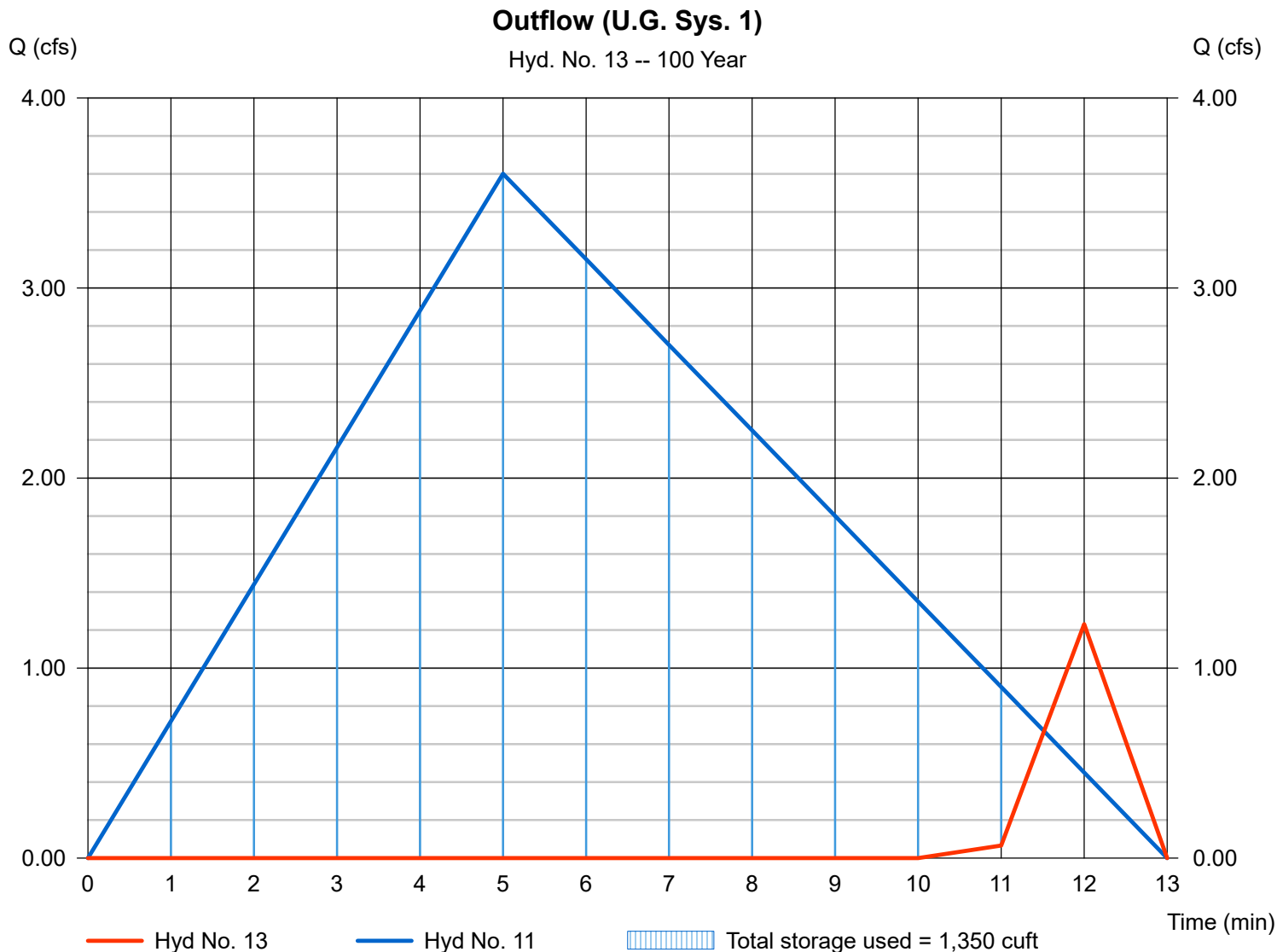

# Hydrograph Report

## Hyd. No. 14

Inflow (U.G. Sys. 2)

Hydrograph type = Combine  
Storm frequency = 100 yrs  
Time interval = 1 min  
Inflow hyds. = 12, 13

Peak discharge = 6.549 cfs  
Time to peak = 5 min  
Hyd. volume = 2,632 cuft  
Contrib. drain. area = 0.702 ac

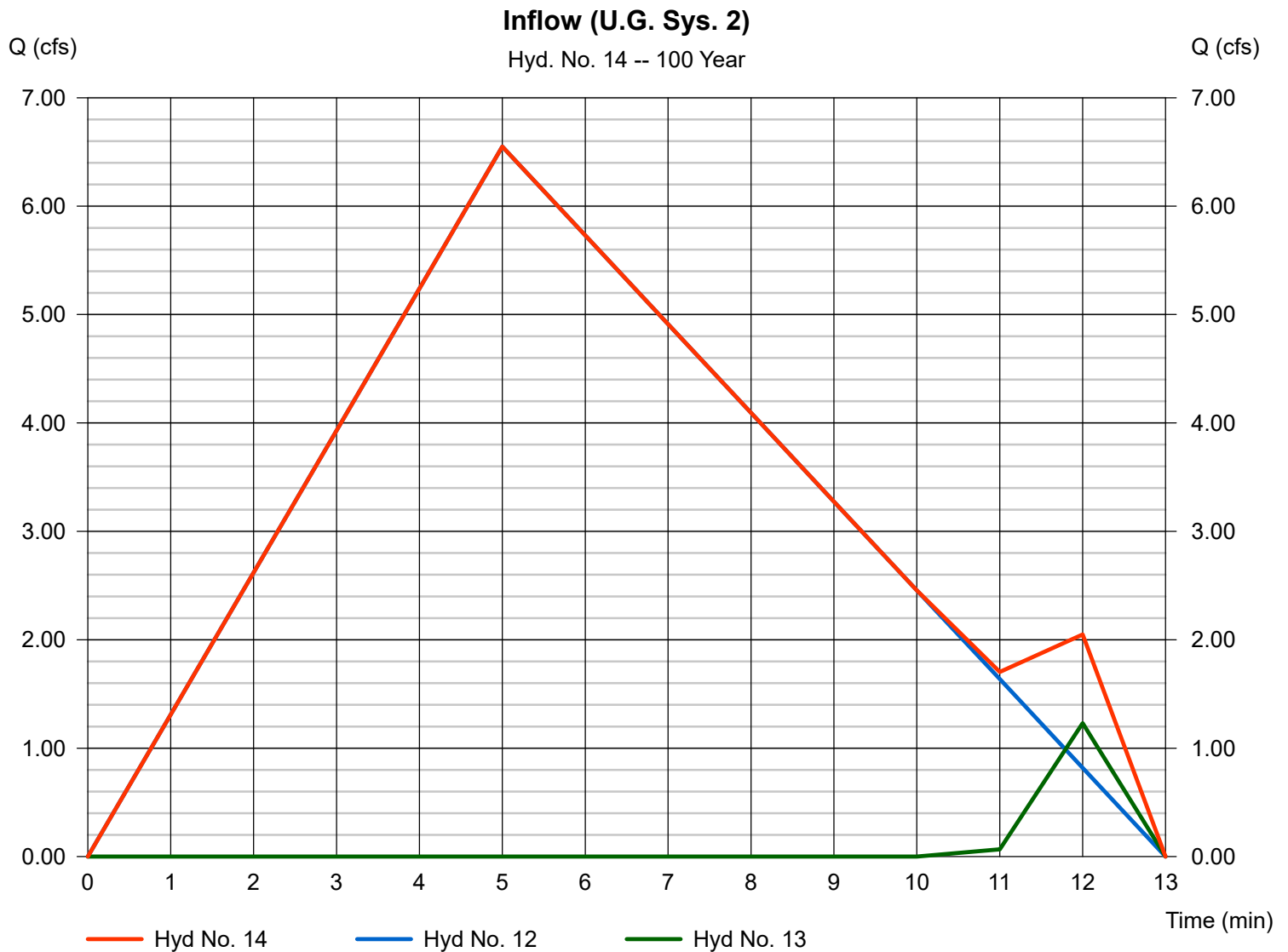

# Hydrograph Report

## Hyd. No. 15

Outflow (U.G. Sys. 2)

Hydrograph type	= Reservoir	Peak discharge	= 1.386 cfs
Storm frequency	= 100 yrs	Time to peak	= 12 min
Time interval	= 1 min	Hyd. volume	= 2,629 cuft
Inflow hyd. No.	= 14 - Inflow (U.G. Sys. 2)	Max. Elevation	= 232.33 ft
Reservoir name	= U.G. STORAGE SYSTEM #2	Max. Storage	= 1,936 cuft

Storage Indication method used.

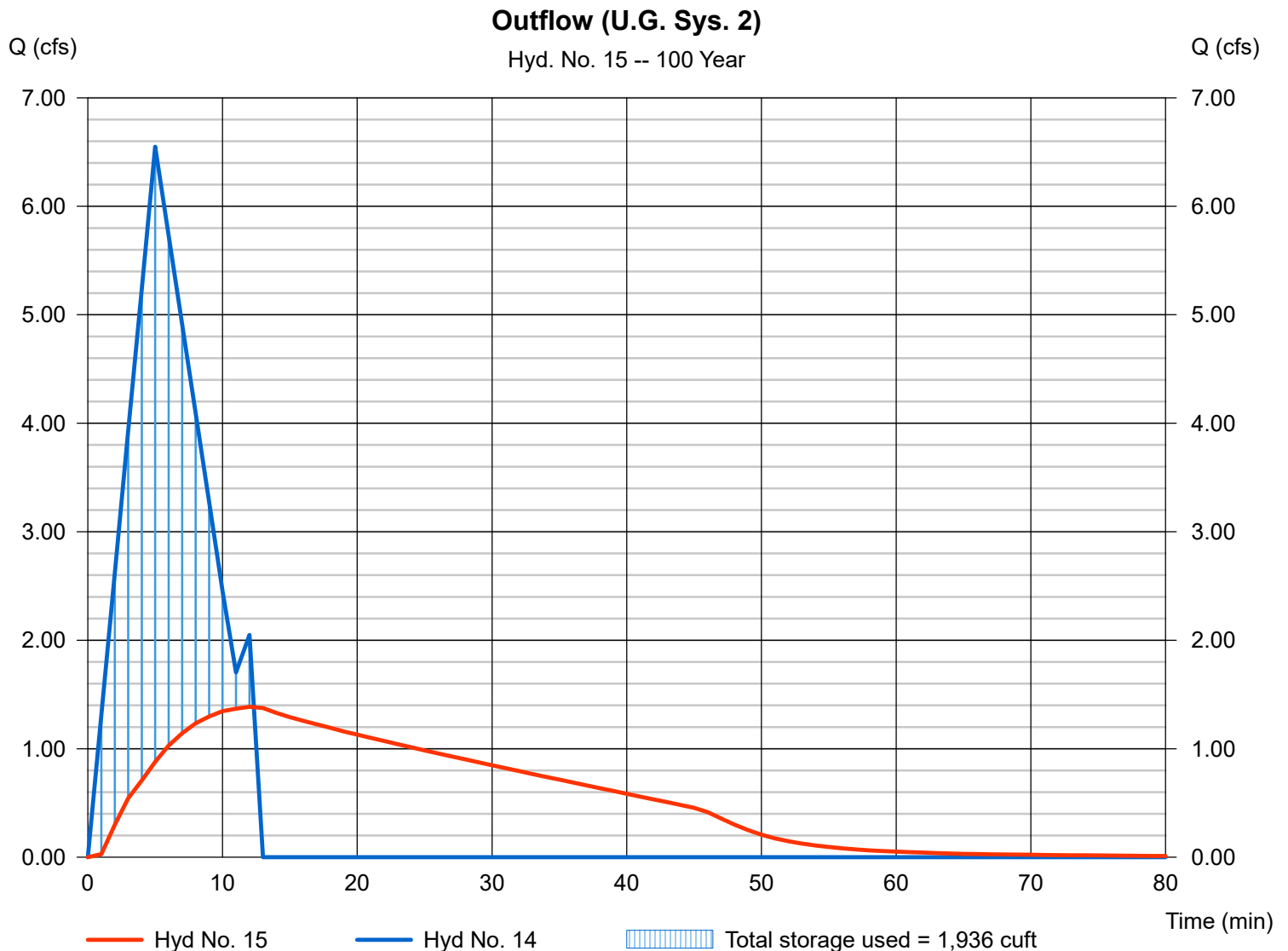

# Hydrograph Report

## Hyd. No. 16

### TOTAL WEST (PRO)

Hydrograph type = Combine  
Storm frequency = 100 yrs  
Time interval = 1 min  
Inflow hyds. = 10, 15

Peak discharge = 7.184 cfs  
Time to peak = 7 min  
Hyd. volume = 5,891 cuft  
Contrib. drain. area = 1.710 ac

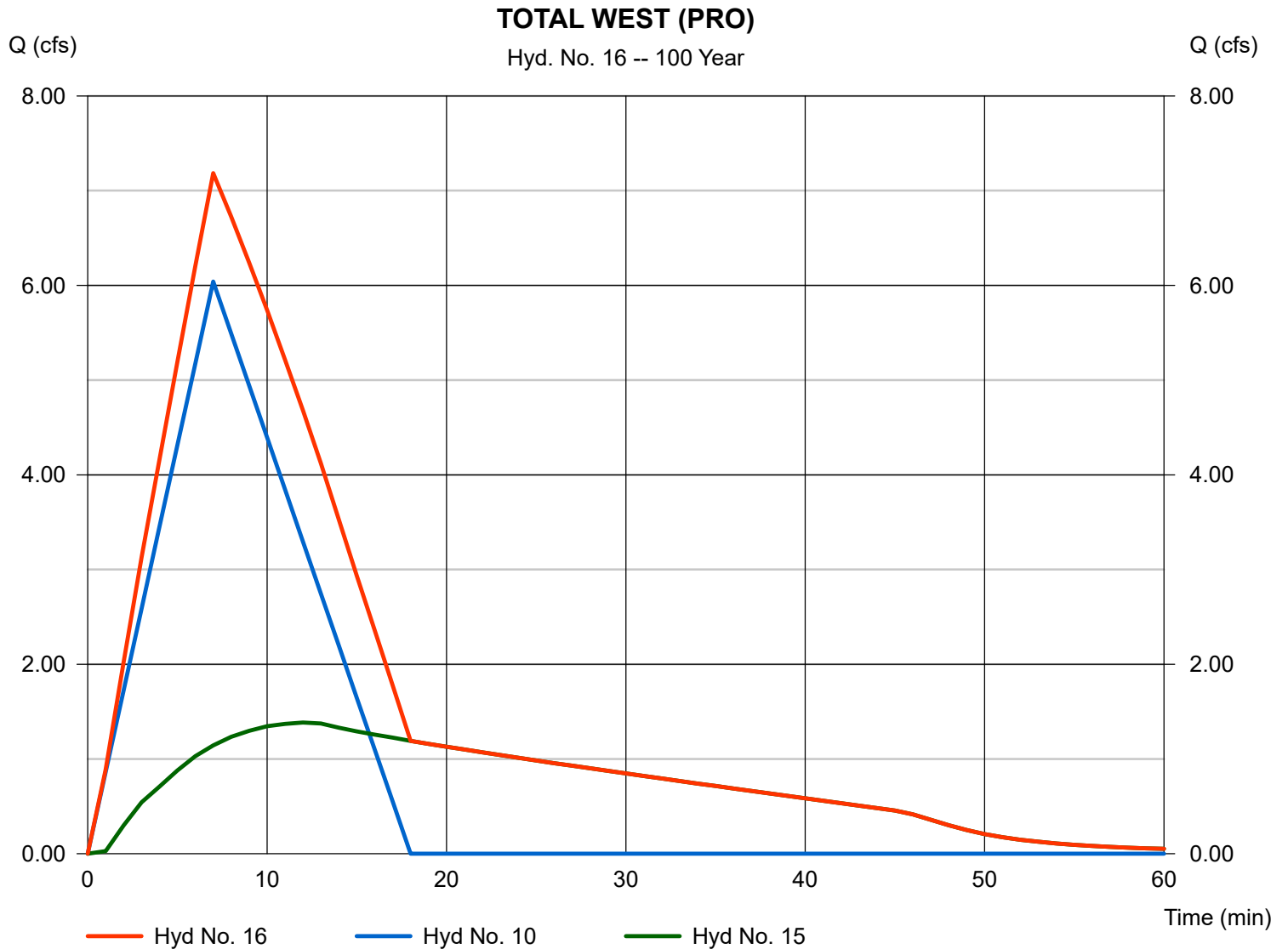





<b>Watershed Model Schematic .....</b>	<b>1</b>
<b>Hydrograph Return Period Recap .....</b>	<b>2</b>
<b>2 - Year</b>	
<b>Summary Report .....</b>	<b>3</b>
<b>Hydrograph Reports .....</b>	<b>4</b>
Hydrograph No. 1, Rational, EAST (EX.) .....	4
TR-55 Tc Worksheet .....	5
Hydrograph No. 2, Rational, WEST (EX) .....	6
TR-55 Tc Worksheet .....	7
Hydrograph No. 3, Rational, EAST UNDET. (PRO.) .....	8
TR-55 Tc Worksheet .....	9
Hydrograph No. 4, Rational, EAST DET.1 (PRO.) .....	10
Hydrograph No. 5, Rational, EAST DET.2 (PRO.) .....	11
Hydrograph No. 6, Reservoir, Outflow (U.G. Sys. 3) .....	12
Pond Report - U.G. STORAGE SYSTEM #3 .....	13
Hydrograph No. 7, Combine, Inflow (WQ Basin) .....	14
Hydrograph No. 8, Reservoir, Outflow (WQ Basin) .....	15
Pond Report - WQ BASIN .....	16
Hydrograph No. 9, Combine, TOTAL EAST (PRO) .....	17
Hydrograph No. 10, Rational, WEST UNDET. (PRO.) .....	18
TR-55 Tc Worksheet .....	19
Hydrograph No. 11, Rational, WEST DET.1 (PRO.) .....	20
Hydrograph No. 12, Rational, WEST DET.2 (PRO.) .....	21
Hydrograph No. 13, Reservoir, Outflow (U.G. Sys. 1) .....	22
Pond Report - U.G. STORAGE SYSTEM #1 .....	23
Hydrograph No. 14, Combine, Inflow (U.G. Sys. 2) .....	24
Hydrograph No. 15, Reservoir, Outflow (U.G. Sys. 2) .....	25
Pond Report - U.G. STORAGE SYSTEM #2 .....	26
Hydrograph No. 16, Combine, TOTAL WEST (PRO) .....	27
<b>5 - Year</b>	
<b>Summary Report .....</b>	<b>28</b>
<b>Hydrograph Reports .....</b>	<b>29</b>
Hydrograph No. 1, Rational, EAST (EX.) .....	29
Hydrograph No. 2, Rational, WEST (EX) .....	30
Hydrograph No. 3, Rational, EAST UNDET. (PRO.) .....	31
Hydrograph No. 4, Rational, EAST DET.1 (PRO.) .....	32
Hydrograph No. 5, Rational, EAST DET.2 (PRO.) .....	33
Hydrograph No. 6, Reservoir, Outflow (U.G. Sys. 3) .....	34
Hydrograph No. 7, Combine, Inflow (WQ Basin) .....	35
Hydrograph No. 8, Reservoir, Outflow (WQ Basin) .....	36
Hydrograph No. 9, Combine, TOTAL EAST (PRO) .....	37
Hydrograph No. 10, Rational, WEST UNDET. (PRO.) .....	38
Hydrograph No. 11, Rational, WEST DET.1 (PRO.) .....	39
Hydrograph No. 12, Rational, WEST DET.2 (PRO.) .....	40
Hydrograph No. 13, Reservoir, Outflow (U.G. Sys. 1) .....	41
Hydrograph No. 14, Combine, Inflow (U.G. Sys. 2) .....	42

Hydrograph No. 15, Reservoir, Outflow (U.G. Sys. 2) .....	43
Hydrograph No. 16, Combine, TOTAL WEST (PRO) .....	44

**10 - Year**

<b>Summary Report .....</b>	<b>45</b>
<b>Hydrograph Reports .....</b>	<b>46</b>
Hydrograph No. 1, Rational, EAST (EX.) .....	46
Hydrograph No. 2, Rational, WEST (EX) .....	47
Hydrograph No. 3, Rational, EAST UNDET. (PRO.) .....	48
Hydrograph No. 4, Rational, EAST DET.1 (PRO.) .....	49
Hydrograph No. 5, Rational, EAST DET.2 (PRO.) .....	50
Hydrograph No. 6, Reservoir, Outflow (U.G. Sys. 3) .....	51
Hydrograph No. 7, Combine, Inflow (WQ Basin) .....	52
Hydrograph No. 8, Reservoir, Outflow (WQ Basin) .....	53
Hydrograph No. 9, Combine, TOTAL EAST (PRO) .....	54
Hydrograph No. 10, Rational, WEST UNDET. (PRO.) .....	55
Hydrograph No. 11, Rational, WEST DET.1 (PRO.) .....	56
Hydrograph No. 12, Rational, WEST DET.2 (PRO.) .....	57
Hydrograph No. 13, Reservoir, Outflow (U.G. Sys. 1) .....	58
Hydrograph No. 14, Combine, Inflow (U.G. Sys. 2) .....	59
Hydrograph No. 15, Reservoir, Outflow (U.G. Sys. 2) .....	60
Hydrograph No. 16, Combine, TOTAL WEST (PRO) .....	61

**25 - Year**

<b>Summary Report .....</b>	<b>62</b>
<b>Hydrograph Reports .....</b>	<b>63</b>
Hydrograph No. 1, Rational, EAST (EX.) .....	63
Hydrograph No. 2, Rational, WEST (EX) .....	64
Hydrograph No. 3, Rational, EAST UNDET. (PRO.) .....	65
Hydrograph No. 4, Rational, EAST DET.1 (PRO.) .....	66
Hydrograph No. 5, Rational, EAST DET.2 (PRO.) .....	67
Hydrograph No. 6, Reservoir, Outflow (U.G. Sys. 3) .....	68
Hydrograph No. 7, Combine, Inflow (WQ Basin) .....	69
Hydrograph No. 8, Reservoir, Outflow (WQ Basin) .....	70
Hydrograph No. 9, Combine, TOTAL EAST (PRO) .....	71
Hydrograph No. 10, Rational, WEST UNDET. (PRO.) .....	72
Hydrograph No. 11, Rational, WEST DET.1 (PRO.) .....	73
Hydrograph No. 12, Rational, WEST DET.2 (PRO.) .....	74
Hydrograph No. 13, Reservoir, Outflow (U.G. Sys. 1) .....	75
Hydrograph No. 14, Combine, Inflow (U.G. Sys. 2) .....	76
Hydrograph No. 15, Reservoir, Outflow (U.G. Sys. 2) .....	77
Hydrograph No. 16, Combine, TOTAL WEST (PRO) .....	78

**50 - Year**

<b>Summary Report .....</b>	<b>79</b>
<b>Hydrograph Reports .....</b>	<b>80</b>
Hydrograph No. 1, Rational, EAST (EX.) .....	80
Hydrograph No. 2, Rational, WEST (EX) .....	81
Hydrograph No. 3, Rational, EAST UNDET. (PRO.) .....	82
Hydrograph No. 4, Rational, EAST DET.1 (PRO.) .....	83
Hydrograph No. 5, Rational, EAST DET.2 (PRO.) .....	84
Hydrograph No. 6, Reservoir, Outflow (U.G. Sys. 3) .....	85

Hydrograph No. 7, Combine, Inflow (WQ Basin) .....	86
Hydrograph No. 8, Reservoir, Outflow (WQ Basin) .....	87
Hydrograph No. 9, Combine, TOTAL EAST (PRO) .....	88
Hydrograph No. 10, Rational, WEST UNDET. (PRO.) .....	89
Hydrograph No. 11, Rational, WEST DET.1 (PRO.) .....	90
Hydrograph No. 12, Rational, WEST DET.2 (PRO.) .....	91
Hydrograph No. 13, Reservoir, Outflow (U.G. Sys. 1) .....	92
Hydrograph No. 14, Combine, Inflow (U.G. Sys. 2) .....	93
Hydrograph No. 15, Reservoir, Outflow (U.G. Sys. 2) .....	94
Hydrograph No. 16, Combine, TOTAL WEST (PRO) .....	95

**100 - Year**

<b>Summary Report .....</b>	<b>96</b>
<b>Hydrograph Reports .....</b>	<b>97</b>
Hydrograph No. 1, Rational, EAST (EX.) .....	97
Hydrograph No. 2, Rational, WEST (EX) .....	98
Hydrograph No. 3, Rational, EAST UNDET. (PRO.) .....	99
Hydrograph No. 4, Rational, EAST DET.1 (PRO.) .....	100
Hydrograph No. 5, Rational, EAST DET.2 (PRO.) .....	101
Hydrograph No. 6, Reservoir, Outflow (U.G. Sys. 3) .....	102
Hydrograph No. 7, Combine, Inflow (WQ Basin) .....	103
Hydrograph No. 8, Reservoir, Outflow (WQ Basin) .....	104
Hydrograph No. 9, Combine, TOTAL EAST (PRO) .....	105
Hydrograph No. 10, Rational, WEST UNDET. (PRO.) .....	106
Hydrograph No. 11, Rational, WEST DET.1 (PRO.) .....	107
Hydrograph No. 12, Rational, WEST DET.2 (PRO.) .....	108
Hydrograph No. 13, Reservoir, Outflow (U.G. Sys. 1) .....	109
Hydrograph No. 14, Combine, Inflow (U.G. Sys. 2) .....	110
Hydrograph No. 15, Reservoir, Outflow (U.G. Sys. 2) .....	111
Hydrograph No. 16, Combine, TOTAL WEST (PRO) .....	112

<b>IDF Report .....</b>	<b>113</b>
-------------------------	------------

# NOAA ATLAS 14 Precipitation Data



**NOAA Atlas 14, Volume 10, Version 3**  
**Location name: Simsbury, Connecticut, USA\***  
**Latitude: 41.8805°, Longitude: -72.8°**  
**Elevation: 177.93 ft\*\***  
\* source: ESRI Maps  
\*\* source: USGS



**POINT PRECIPITATION FREQUENCY ESTIMATES**

Sanja Perica, Sandra Pavlovic, Michael St. Laurent, Carl Trypaluk, Dale Unruh, Orlan Wilhite

NOAA, National Weather Service, Silver Spring, Maryland

[PF tabular](#) | [PF graphical](#) | [Maps & aerials](#)

**PF tabular**

<b>PDS-based point precipitation frequency estimates with 90% confidence intervals (in inches)<sup>1</sup></b>										
Duration	Average recurrence interval (years)									
	1	2	5	10	25	50	100	200	500	1000
<b>5-min</b>	<b>0.348</b> (0.268-0.450)	<b>0.417</b> (0.320-0.539)	<b>0.529</b> (0.405-0.686)	<b>0.622</b> (0.474-0.811)	<b>0.750</b> (0.554-1.02)	<b>0.846</b> (0.614-1.18)	<b>0.947</b> (0.668-1.37)	<b>1.06</b> (0.711-1.58)	<b>1.22</b> (0.788-1.88)	<b>1.35</b> (0.853-2.13)
<b>10-min</b>	<b>0.493</b> (0.379-0.637)	<b>0.591</b> (0.454-0.763)	<b>0.750</b> (0.575-0.973)	<b>0.881</b> (0.671-1.15)	<b>1.06</b> (0.785-1.45)	<b>1.20</b> (0.868-1.67)	<b>1.34</b> (0.946-1.95)	<b>1.50</b> (1.01-2.24)	<b>1.73</b> (1.12-2.67)	<b>1.91</b> (1.21-3.02)
<b>15-min</b>	<b>0.581</b> (0.446-0.749)	<b>0.695</b> (0.534-0.898)	<b>0.881</b> (0.675-1.14)	<b>1.04</b> (0.789-1.35)	<b>1.25</b> (0.923-1.71)	<b>1.41</b> (1.02-1.97)	<b>1.58</b> (1.11-2.29)	<b>1.77</b> (1.18-2.63)	<b>2.03</b> (1.31-3.14)	<b>2.25</b> (1.42-3.55)
<b>30-min</b>	<b>0.784</b> (0.603-1.01)	<b>0.942</b> (0.723-1.22)	<b>1.20</b> (0.919-1.56)	<b>1.41</b> (1.08-1.84)	<b>1.71</b> (1.26-2.33)	<b>1.93</b> (1.40-2.70)	<b>2.16</b> (1.52-3.14)	<b>2.42</b> (1.62-3.60)	<b>2.78</b> (1.80-4.30)	<b>3.08</b> (1.95-4.86)
<b>60-min</b>	<b>0.988</b> (0.760-1.27)	<b>1.19</b> (0.913-1.54)	<b>1.52</b> (1.16-1.97)	<b>1.79</b> (1.36-2.34)	<b>2.16</b> (1.60-2.96)	<b>2.45</b> (1.77-3.42)	<b>2.74</b> (1.93-3.98)	<b>3.07</b> (2.06-4.57)	<b>3.53</b> (2.29-5.46)	<b>3.91</b> (2.47-6.18)
<b>2-hr</b>	<b>1.27</b> (0.985-1.63)	<b>1.53</b> (1.18-1.96)	<b>1.94</b> (1.50-2.50)	<b>2.28</b> (1.75-2.96)	<b>2.76</b> (2.05-3.75)	<b>3.11</b> (2.28-4.34)	<b>3.49</b> (2.49-5.07)	<b>3.93</b> (2.64-5.83)	<b>4.58</b> (2.97-7.05)	<b>5.13</b> (3.26-8.07)
<b>3-hr</b>	<b>1.47</b> (1.14-1.87)	<b>1.76</b> (1.37-2.25)	<b>2.24</b> (1.73-2.88)	<b>2.64</b> (2.03-3.41)	<b>3.19</b> (2.39-4.33)	<b>3.60</b> (2.64-5.01)	<b>4.04</b> (2.90-5.88)	<b>4.56</b> (3.08-6.75)	<b>5.37</b> (3.49-8.24)	<b>6.05</b> (3.85-9.49)
<b>6-hr</b>	<b>1.84</b> (1.44-2.33)	<b>2.23</b> (1.74-2.83)	<b>2.87</b> (2.23-3.66)	<b>3.40</b> (2.63-4.36)	<b>4.13</b> (3.11-5.59)	<b>4.66</b> (3.45-6.48)	<b>5.25</b> (3.80-7.65)	<b>5.98</b> (4.05-8.80)	<b>7.11</b> (4.64-10.9)	<b>8.10</b> (5.17-12.6)
<b>12-hr</b>	<b>2.26</b> (1.78-2.84)	<b>2.78</b> (2.19-3.51)	<b>3.64</b> (2.85-4.61)	<b>4.35</b> (3.39-5.54)	<b>5.33</b> (4.04-7.18)	<b>6.04</b> (4.51-8.38)	<b>6.83</b> (4.99-9.94)	<b>7.83</b> (5.32-11.5)	<b>9.41</b> (6.16-14.3)	<b>10.8</b> (6.91-16.8)
<b>24-hr</b>	<b>2.63</b> (2.09-3.29)	<b>3.31</b> (2.62-4.14)	<b>4.41</b> (3.48-5.55)	<b>5.32</b> (4.18-6.74)	<b>6.58</b> (5.03-8.85)	<b>7.50</b> (5.64-10.4)	<b>8.52</b> (6.29-12.4)	<b>9.86</b> (6.72-14.4)	<b>12.0</b> (7.88-18.2)	<b>13.9</b> (8.93-21.5)
<b>2-day</b>	<b>2.95</b> (2.35-3.66)	<b>3.77</b> (3.00-4.69)	<b>5.11</b> (4.06-6.38)	<b>6.22</b> (4.91-7.82)	<b>7.75</b> (5.97-10.4)	<b>8.85</b> (6.72-12.2)	<b>10.1</b> (7.54-14.8)	<b>11.8</b> (8.07-17.1)	<b>14.6</b> (9.62-22.0)	<b>17.2</b> (11.0-26.4)
<b>3-day</b>	<b>3.21</b> (2.57-3.98)	<b>4.11</b> (3.29-5.10)	<b>5.59</b> (4.46-6.96)	<b>6.81</b> (5.40-8.54)	<b>8.50</b> (6.58-11.4)	<b>9.72</b> (7.41-13.4)	<b>11.1</b> (8.32-16.2)	<b>13.0</b> (8.90-18.8)	<b>16.2</b> (10.6-24.3)	<b>19.0</b> (12.3-29.2)
<b>4-day</b>	<b>3.46</b> (2.78-4.27)	<b>4.42</b> (3.55-5.47)	<b>6.00</b> (4.80-7.45)	<b>7.31</b> (5.81-9.13)	<b>9.11</b> (7.07-12.2)	<b>10.4</b> (7.96-14.3)	<b>11.9</b> (8.94-17.3)	<b>13.9</b> (9.55-20.1)	<b>17.3</b> (11.4-26.0)	<b>20.4</b> (13.2-31.2)
<b>7-day</b>	<b>4.14</b> (3.35-5.09)	<b>5.24</b> (4.22-6.44)	<b>7.02</b> (5.65-8.67)	<b>8.50</b> (6.79-10.6)	<b>10.5</b> (8.21-14.0)	<b>12.0</b> (9.21-16.4)	<b>13.7</b> (10.3-19.8)	<b>15.9</b> (11.0-22.9)	<b>19.7</b> (13.0-29.4)	<b>23.0</b> (14.9-35.1)
<b>10-day</b>	<b>4.83</b> (3.91-5.91)	<b>5.98</b> (4.84-7.33)	<b>7.87</b> (6.35-9.68)	<b>9.43</b> (7.56-11.7)	<b>11.6</b> (9.05-15.3)	<b>13.1</b> (10.1-17.9)	<b>14.9</b> (11.2-21.4)	<b>17.3</b> (11.9-24.7)	<b>21.1</b> (14.0-31.4)	<b>24.5</b> (15.9-37.3)
<b>20-day</b>	<b>6.97</b> (5.69-8.47)	<b>8.17</b> (6.66-9.94)	<b>10.1</b> (8.24-12.4)	<b>11.8</b> (9.50-14.5)	<b>14.0</b> (11.0-18.2)	<b>15.7</b> (12.0-21.0)	<b>17.5</b> (13.1-24.6)	<b>19.8</b> (13.8-28.2)	<b>23.5</b> (15.6-34.7)	<b>26.7</b> (17.4-40.4)
<b>30-day</b>	<b>8.77</b> (7.19-10.6)	<b>9.99</b> (8.18-12.1)	<b>12.0</b> (9.78-14.6)	<b>13.6</b> (11.1-16.7)	<b>15.9</b> (12.5-20.5)	<b>17.6</b> (13.5-23.3)	<b>19.4</b> (14.5-26.9)	<b>21.6</b> (15.1-30.6)	<b>25.0</b> (16.7-36.8)	<b>27.8</b> (18.1-41.9)
<b>45-day</b>	<b>11.0</b> (9.07-13.3)	<b>12.3</b> (10.1-14.8)	<b>14.3</b> (11.7-17.4)	<b>16.0</b> (13.0-19.6)	<b>18.4</b> (14.4-23.5)	<b>20.2</b> (15.4-26.4)	<b>22.0</b> (16.3-29.9)	<b>24.0</b> (16.8-33.8)	<b>26.8</b> (18.0-39.4)	<b>29.1</b> (19.0-43.8)
<b>60-day</b>	<b>12.9</b> (10.6-15.5)	<b>14.2</b> (11.7-17.1)	<b>16.3</b> (13.4-19.7)	<b>18.1</b> (14.8-22.0)	<b>20.6</b> (16.1-26.0)	<b>22.4</b> (17.2-29.1)	<b>24.3</b> (17.9-32.7)	<b>26.2</b> (18.4-36.7)	<b>28.5</b> (19.2-41.7)	<b>30.3</b> (19.8-45.4)

<sup>1</sup> Precipitation frequency (PF) estimates in this table are based on frequency analysis of partial duration series (PDS). Numbers in parenthesis are PF estimates at lower and upper bounds of the 90% confidence interval. The probability that precipitation frequency estimates (for a given duration and average recurrence interval) will be greater than the upper bound (or less than the lower bound) is 5%. Estimates at upper bounds are not checked against probable maximum precipitation (PMP) estimates and may be higher than currently valid PMP values. Please refer to NOAA Atlas 14 document for more information.

[Back to Top](#)

**PF graphical**

### PDS-based depth-duration-frequency (DDF) curves

Latitude: 41.8805°, Longitude: -72.8000°

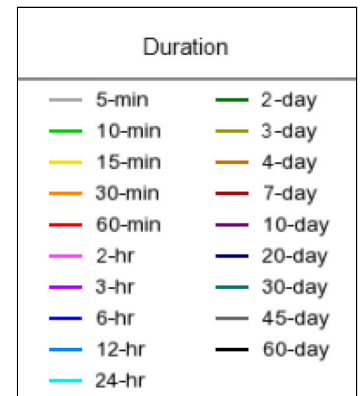
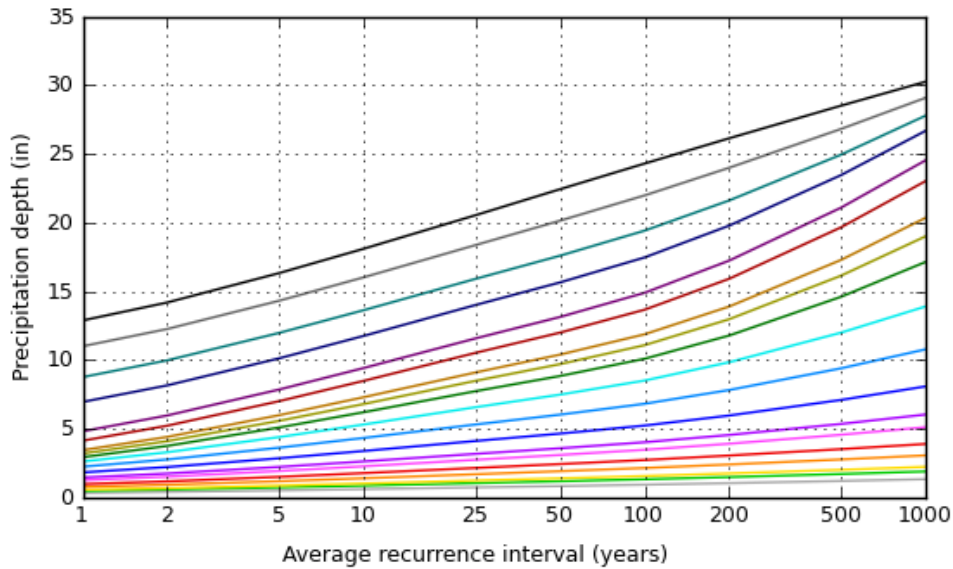
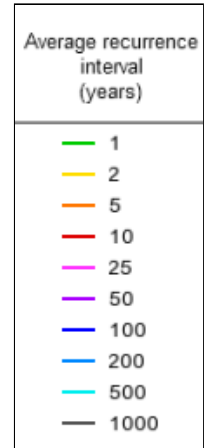
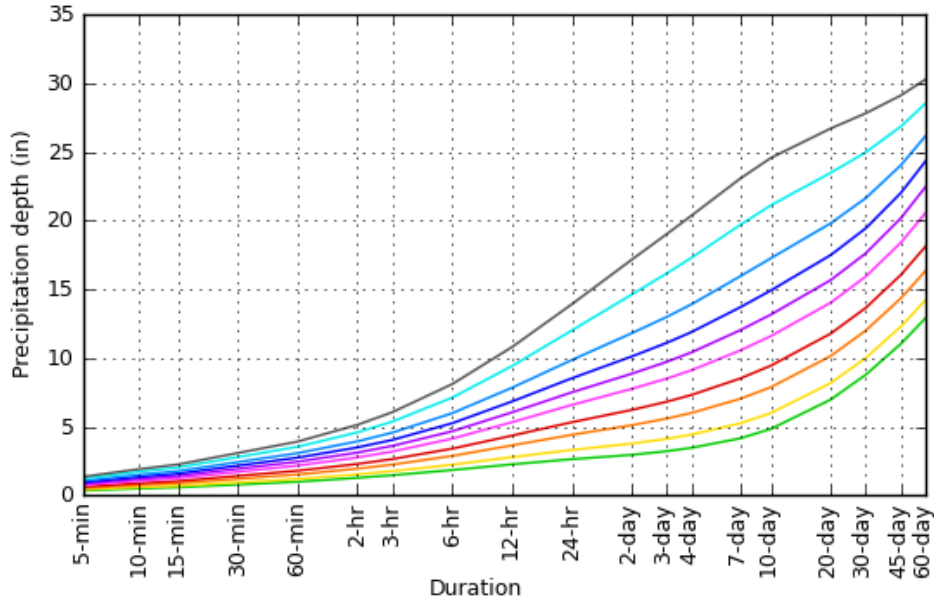

[Back to Top](#)

### Maps & aerials

Small scale terrain

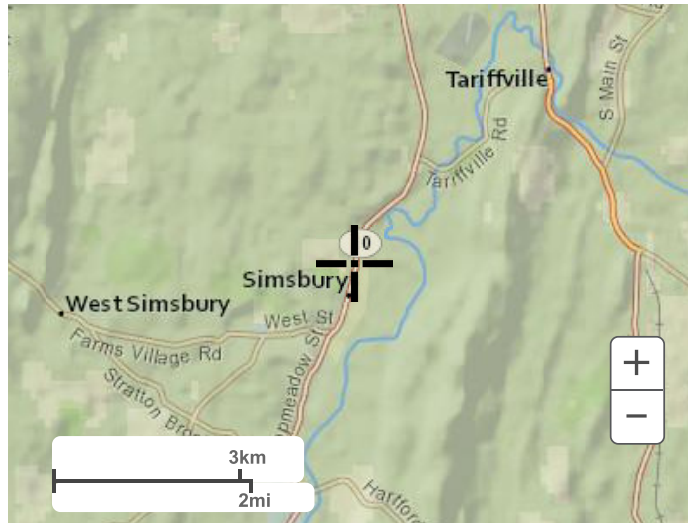

Large scale terrain

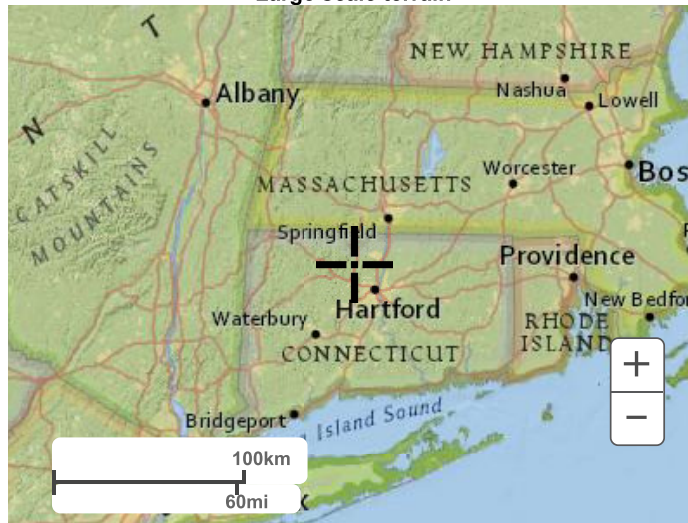

Large scale map

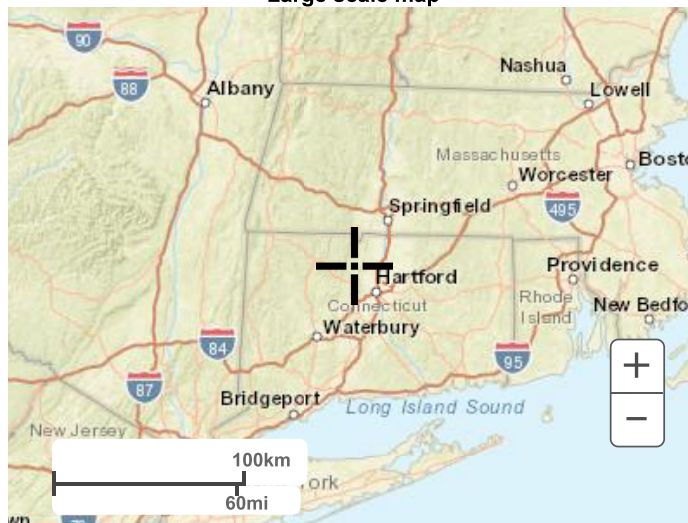

Large scale aerial

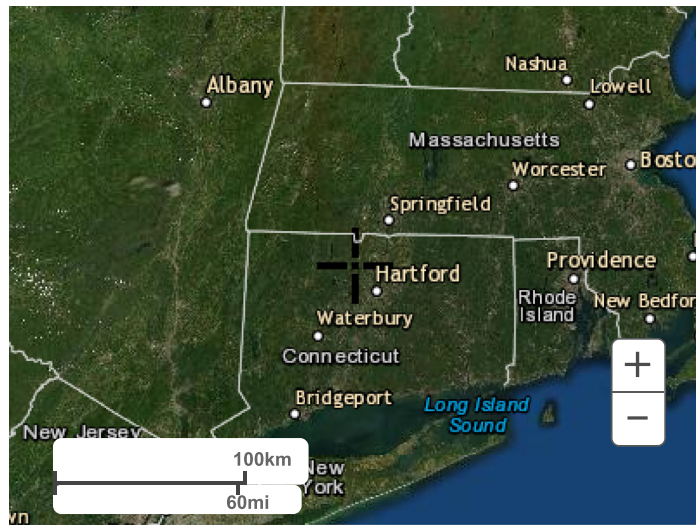

[Back to Top](#)

---

[US Department of Commerce](#)  
[National Oceanic and Atmospheric Administration](#)  
[National Weather Service](#)  
[National Water Center](#)  
1325 East West Highway  
Silver Spring, MD 20910  
Questions?: [HDSC.Questions@noaa.gov](mailto:HDSC.Questions@noaa.gov)

[Disclaimer](#)





**NOAA Atlas 14, Volume 10, Version 3**  
**Location name: Simsbury, Connecticut, USA\***  
**Latitude: 41.8805°, Longitude: -72.8°**  
**Elevation: 177.93 ft\*\***  
 \* source: ESRI Maps  
 \*\* source: USGS



**POINT PRECIPITATION FREQUENCY ESTIMATES**

Sanja Perica, Sandra Pavlovic, Michael St. Laurent, Carl Trypaluk, Dale Unruh, Orlan Wilhite

NOAA, National Weather Service, Silver Spring, Maryland

[PF\\_tabular](#) | [PF\\_graphical](#) | [Maps & aerials](#)

**PF tabular**

<b>PDS-based point precipitation frequency estimates with 90% confidence intervals (in inches/hour)<sup>1</sup></b>										
Duration	Average recurrence interval (years)									
	1	2	5	10	25	50	100	200	500	1000
5-min	4.18 (3.22-5.40)	5.00 (3.84-6.47)	6.35 (4.86-8.23)	7.46 (5.69-9.73)	9.00 (6.65-12.3)	10.2 (7.37-14.2)	11.4 (8.02-16.5)	12.7 (8.53-18.9)	14.6 (9.46-22.6)	16.2 (10.2-25.5)
10-min	2.96 (2.27-3.82)	3.55 (2.72-4.58)	4.50 (3.45-5.84)	5.29 (4.03-6.89)	6.37 (4.71-8.71)	7.19 (5.21-10.0)	8.05 (5.68-11.7)	9.00 (6.04-13.4)	10.4 (6.70-16.0)	11.5 (7.25-18.1)
15-min	2.32 (1.78-3.00)	2.78 (2.14-3.59)	3.52 (2.70-4.57)	4.14 (3.16-5.41)	5.00 (3.69-6.83)	5.64 (4.09-7.88)	6.31 (4.45-9.16)	7.06 (4.74-10.5)	8.12 (5.26-12.6)	8.98 (5.68-14.2)
30-min	1.57 (1.21-2.02)	1.88 (1.45-2.43)	2.40 (1.84-3.11)	2.83 (2.15-3.69)	3.41 (2.52-4.66)	3.86 (2.80-5.39)	4.32 (3.05-6.27)	4.83 (3.24-7.20)	5.56 (3.60-8.60)	6.16 (3.90-9.72)
60-min	0.988 (0.760-1.27)	1.19 (0.913-1.54)	1.52 (1.16-1.97)	1.79 (1.36-2.34)	2.16 (1.60-2.96)	2.45 (1.77-3.42)	2.74 (1.93-3.98)	3.07 (2.06-4.57)	3.53 (2.29-5.46)	3.91 (2.47-6.18)
2-hr	0.636 (0.492-0.816)	0.763 (0.590-0.980)	0.970 (0.748-1.25)	1.14 (0.875-1.48)	1.38 (1.03-1.88)	1.56 (1.14-2.17)	1.74 (1.24-2.54)	1.96 (1.32-2.91)	2.29 (1.49-3.53)	2.56 (1.63-4.03)
3-hr	0.488 (0.379-0.623)	0.586 (0.455-0.749)	0.746 (0.577-0.957)	0.879 (0.676-1.14)	1.06 (0.795-1.44)	1.20 (0.880-1.67)	1.34 (0.965-1.96)	1.52 (1.02-2.25)	1.79 (1.16-2.74)	2.02 (1.28-3.16)
6-hr	0.307 (0.240-0.390)	0.372 (0.291-0.473)	0.479 (0.373-0.611)	0.567 (0.439-0.728)	0.689 (0.519-0.933)	0.779 (0.577-1.08)	0.877 (0.635-1.28)	0.998 (0.676-1.47)	1.19 (0.775-1.82)	1.35 (0.863-2.11)
12-hr	0.187 (0.147-0.236)	0.231 (0.181-0.291)	0.302 (0.237-0.382)	0.361 (0.281-0.460)	0.442 (0.335-0.596)	0.501 (0.374-0.695)	0.567 (0.414-0.825)	0.650 (0.442-0.953)	0.781 (0.511-1.19)	0.896 (0.573-1.39)
24-hr	0.110 (0.087-0.137)	0.138 (0.109-0.173)	0.184 (0.145-0.231)	0.222 (0.174-0.281)	0.274 (0.210-0.369)	0.312 (0.235-0.432)	0.355 (0.262-0.517)	0.411 (0.280-0.599)	0.500 (0.328-0.758)	0.580 (0.372-0.896)
2-day	0.061 (0.049-0.076)	0.078 (0.063-0.098)	0.106 (0.084-0.133)	0.130 (0.102-0.163)	0.161 (0.124-0.217)	0.184 (0.140-0.255)	0.211 (0.157-0.308)	0.246 (0.168-0.357)	0.304 (0.200-0.459)	0.357 (0.230-0.549)
3-day	0.045 (0.036-0.055)	0.057 (0.046-0.071)	0.078 (0.062-0.097)	0.095 (0.075-0.119)	0.118 (0.091-0.158)	0.135 (0.103-0.186)	0.154 (0.116-0.225)	0.180 (0.124-0.261)	0.224 (0.148-0.337)	0.264 (0.170-0.405)
4-day	0.036 (0.029-0.045)	0.046 (0.037-0.057)	0.063 (0.050-0.078)	0.076 (0.061-0.095)	0.095 (0.074-0.127)	0.108 (0.083-0.149)	0.124 (0.093-0.180)	0.145 (0.099-0.209)	0.180 (0.119-0.270)	0.212 (0.137-0.325)
7-day	0.025 (0.020-0.030)	0.031 (0.025-0.038)	0.042 (0.034-0.052)	0.051 (0.040-0.063)	0.063 (0.049-0.083)	0.071 (0.055-0.098)	0.081 (0.061-0.118)	0.095 (0.065-0.136)	0.117 (0.078-0.175)	0.137 (0.089-0.209)
10-day	0.020 (0.016-0.025)	0.025 (0.020-0.031)	0.033 (0.026-0.040)	0.039 (0.032-0.049)	0.048 (0.038-0.064)	0.055 (0.042-0.074)	0.062 (0.047-0.089)	0.072 (0.050-0.103)	0.088 (0.058-0.131)	0.102 (0.066-0.155)
20-day	0.015 (0.012-0.018)	0.017 (0.014-0.021)	0.021 (0.017-0.026)	0.025 (0.020-0.030)	0.029 (0.023-0.038)	0.033 (0.025-0.044)	0.036 (0.027-0.051)	0.041 (0.029-0.059)	0.049 (0.033-0.072)	0.056 (0.036-0.084)
30-day	0.012 (0.010-0.015)	0.014 (0.011-0.017)	0.017 (0.014-0.020)	0.019 (0.015-0.023)	0.022 (0.017-0.028)	0.024 (0.019-0.032)	0.027 (0.020-0.037)	0.030 (0.021-0.042)	0.035 (0.023-0.051)	0.039 (0.025-0.058)
45-day	0.010 (0.008-0.012)	0.011 (0.009-0.014)	0.013 (0.011-0.016)	0.015 (0.012-0.018)	0.017 (0.013-0.022)	0.019 (0.014-0.024)	0.020 (0.015-0.028)	0.022 (0.016-0.031)	0.025 (0.017-0.036)	0.027 (0.018-0.041)
60-day	0.009 (0.007-0.011)	0.010 (0.008-0.012)	0.011 (0.009-0.014)	0.013 (0.010-0.015)	0.014 (0.011-0.018)	0.016 (0.012-0.020)	0.017 (0.012-0.023)	0.018 (0.013-0.025)	0.020 (0.013-0.029)	0.021 (0.014-0.032)

<sup>1</sup> Precipitation frequency (PF) estimates in this table are based on frequency analysis of partial duration series (PDS). Numbers in parenthesis are PF estimates at lower and upper bounds of the 90% confidence interval. The probability that precipitation frequency estimates (for a given duration and average recurrence interval) will be greater than the upper bound (or less than the lower bound) is 5%. Estimates at upper bounds are not checked against probable maximum precipitation (PMP) estimates and may be higher than currently valid PMP values. Please refer to NOAA Atlas 14 document for more information.

[Back to Top](#)

**PF graphical**

PDS-based intensity-duration-frequency (IDF) curves

Latitude: 41.8805°, Longitude: -72.8000°

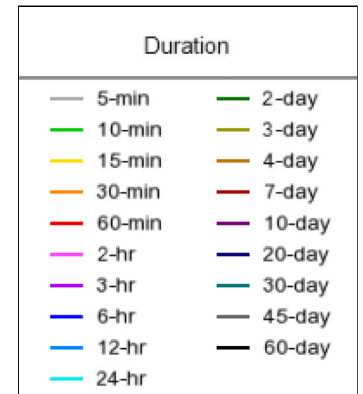
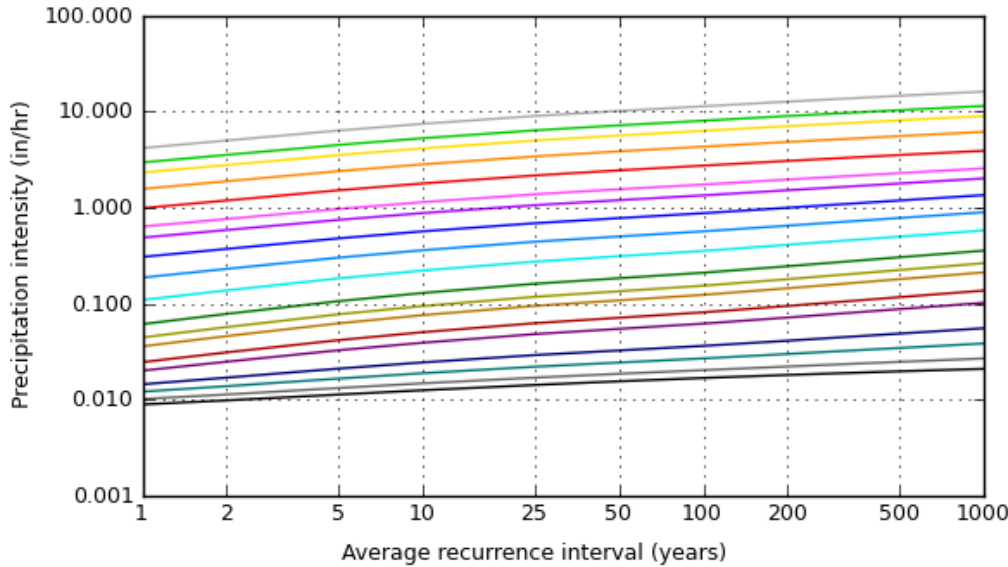
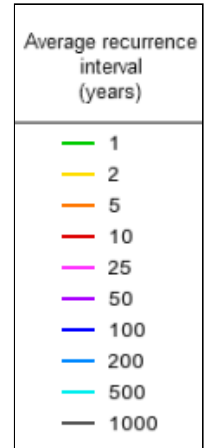
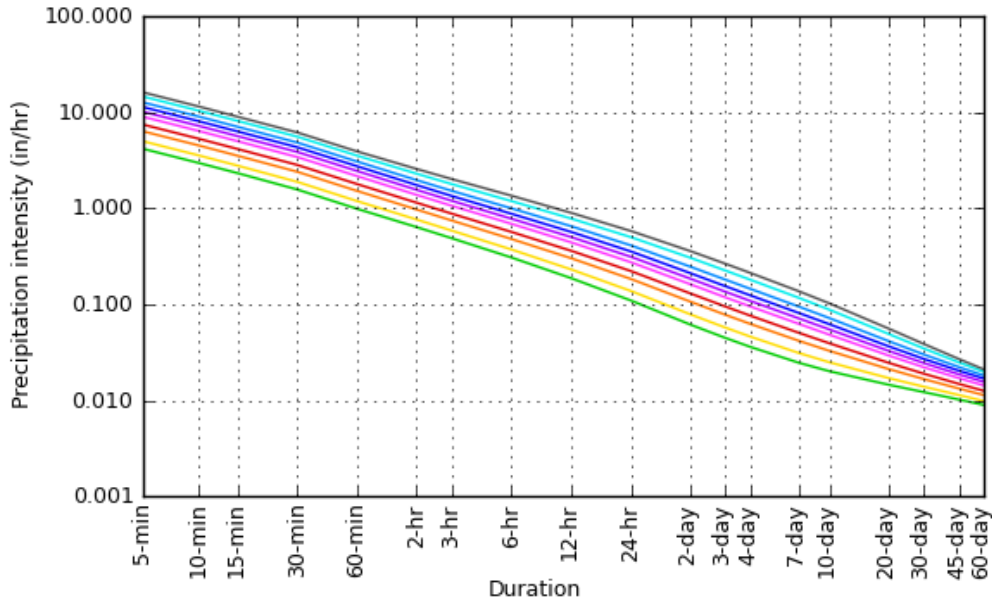

[Back to Top](#)

**Maps & aerials**

**Small scale terrain**

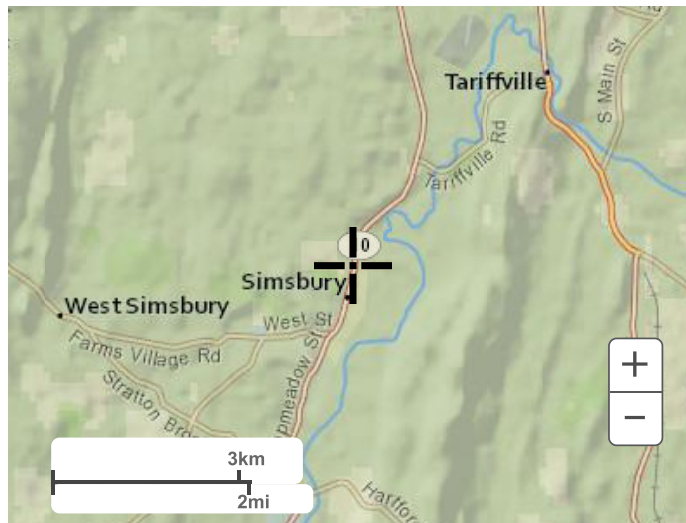

Large scale terrain

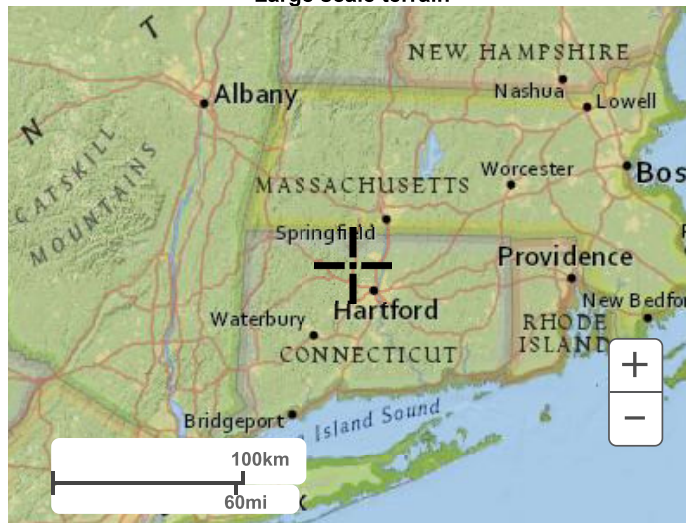

Large scale map



Large scale aerial

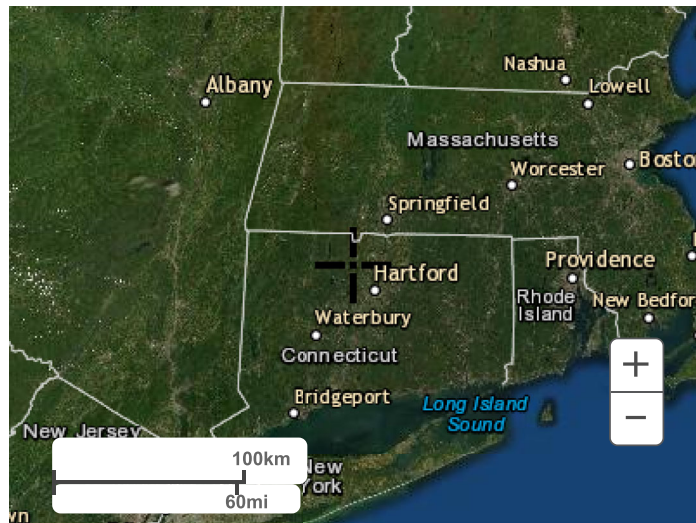

[Back to Top](#)

---

[US Department of Commerce](#)  
[National Oceanic and Atmospheric Administration](#)  
[National Weather Service](#)  
[National Water Center](#)  
1325 East West Highway  
Silver Spring, MD 20910  
Questions?: [HDSC.Questions@noaa.gov](mailto:HDSC.Questions@noaa.gov)

[Disclaimer](#)

Rational Method Runoff Coefficients  
and  
Drainage Area Calculations/Summary

determined from Rainfall-Intensity-Duration curves. The rainfall intensity can be determined from rainfall-intensity-duration Table B-2 which can be found in Appendix B.

### Runoff Coefficient

The runoff coefficient  $C$  is the variable of the rational method least susceptible to precise determination and requires judgment and understanding on the part of the designer. While engineering judgment will always be required in the selection of runoff coefficients, a typical coefficient represents the integrated effects of many drainage basin parameters, the following discussion considers only the effects of soil groups, land use and average land slope.

Methods for determining the runoff coefficient are presented based on hydrologic soil groups and land slope (Table 6-3), land use (Table 6-4) and a composite coefficient for complex watersheds (Table 6-5).

Table 6-3 gives the recommended coefficient  $C$  of runoff for pervious surfaces by selected hydrologic soil groupings and slope ranges. From this table the  $C$  values for non-urban areas such as forest land, agricultural land, and open space can be determined. Soil properties influence the relationship between runoff and rainfall since soils have differing rates of infiltration. Infiltration is the movement of water through the soil surface into the soil. Based on infiltration rates, the NRCS has divided soils into four hydrologic soil groups as follows:

- Group A Soils having a low runoff potential due to high infiltration rates. These soils consist primarily of deep, well drained sands and gravels.
- Group B Soils having a moderately low runoff potential due to moderate infiltration rates. These soils consist primarily of moderately deep to deep, moderately well to well drained soils with moderately fine to moderately coarse textures.
- Group C Soils having a moderately high runoff potential due to slow infiltration rates. These soils consist primarily of soils in which a layer exists near the surface that impedes the downward movement of water or soils with moderately fine to fine texture.
- Group D Soils having a high runoff potential due to very slow infiltration rates. These soils consist primarily of clays with high swelling potential, soils with permanently high water tables, soils with a claypan or clay layer at or near the surface and shallow soils over nearly impervious parent material.

The NRCS has developed detailed soil surveys for all counties within Connecticut. From these documents, the designer can determine the nature and relative percentages of the soils within a given watershed. It is important to note that the level of effort required in the determination of soil types is commensurate with the size of the watershed and the design objectives. Normally, in the computation of discharge quantities for gutter flow analysis and related storm drainage design, a detailed evaluation of soil types is not necessary, as contributing areas adjoining highways are usually relatively small. However, in the design of cross culverts, channels or interceptor ditches the determination of soil types will provide valuable assistance to the design engineer in the evaluation of the runoff potential from a particular watershed.

The second factor for consideration in the determination of a runoff coefficient is land use. As unimproved areas are developed, the potential for increased runoff becomes greater due to the loss of vegetative cover, the reduction in retention by surface depressions and the increase in impervious surface area. Table 6-4 lists recommended ranges for the runoff coefficient value classified with respect to the general character of the tributary area. **The potential for future watershed development should be considered by the designer.**

The final element to be factored into the determination of runoff coefficients is the land slope. As the slope of the drainage basin increases, the selected C value should also increase. This is caused by the fact that as the slope of the drainage area increases, the velocity of overland and channel flow will increase allowing less opportunity for water to infiltrate the ground surface. Thus, more of the rainfall will become runoff from the drainage area.

In summary, it should be reiterated that in assigning a value to the runoff coefficient for use in the rational method, the engineer must rely heavily on experience and judgement.

**Table 6-3 Recommended Coefficient Of Runoff For Pervious Surfaces By Selected Hydrologic Soil Groupings And Slope Ranges**

<u>Slope</u>	<u>A</u>	<u>B</u>	<u>C</u>	<u>D</u>
Flat (0 - 1%)	0.04-0.09	0.07-0.12	0.11-0.16	0.15-0.20
Average (2 - 6%)	0.09-0.14	0.12-0.17	0.16-0.21	0.20-0.25
Steep (Over 6%)	0.13-0.18	0.18-0.24	0.23-0.31	0.28-0.38

Source: Storm Drainage Design Manual, Erie and Niagara Counties Regional Planning Board.

**Table 6-4 Recommended Coefficient Of Runoff Values For Various Selected Land Uses**

<u>Description of Area</u>	<u>Runoff Coefficients</u>
Business: Downtown areas	0.70-0.95
Neighborhood areas	0.50-0.70
Residential: Single-family areas	0.30-0.50
Multi units, detached	0.40-0.60
Multi units, attached	0.60-0.75
Suburban	0.25-0.40
Residential (0.5 ha (1.2 ac) lots or more)	0.30-0.45
Apartment dwelling areas	0.50-0.70
Industrial: Light areas	0.50-0.80
Heavy areas	0.60-0.90
Parks, cemeteries	0.10-0.25
Playgrounds	0.20-0.40
Railroad yard areas	0.20-0.40
Unimproved areas	0.10-0.30

**Table 6-5 Coefficients For Composite Runoff Analysis**

<u>Surface</u>	<u>Runoff Coefficients</u>
Street: Asphalt	0.70-0.95
Concrete	0.80-0.95
Drives and walks	0.75-0.85
Roofs	0.75-0.95



## State of Connecticut

### 13—Walpole sandy loam, 0 to 3 percent slopes

#### Map Unit Setting

*National map unit symbol:* 2svkl

*Elevation:* 0 to 1,020 feet

*Mean annual precipitation:* 36 to 71 inches

*Mean annual air temperature:* 39 to 55 degrees F

*Frost-free period:* 140 to 250 days

*Farmland classification:* Farmland of statewide importance

#### Map Unit Composition

*Walpole and similar soils:* 80 percent

*Minor components:* 20 percent

*Estimates are based on observations, descriptions, and transects of the mapunit.*

#### Description of Walpole

##### Setting

*Landform:* Depressions, outwash plains, outwash terraces, depressions, deltas

*Landform position (two-dimensional):* Toeslope

*Landform position (three-dimensional):* Tread, dip, talf

*Down-slope shape:* Concave

*Across-slope shape:* Concave

*Parent material:* Sandy glaciofluvial deposits derived from igneous, metamorphic and sedimentary rock

##### Typical profile

*Oe - 0 to 1 inches:* mucky peat

*A - 1 to 7 inches:* sandy loam

*Bg - 7 to 21 inches:* sandy loam

*BC - 21 to 25 inches:* gravelly sandy loam

*C - 25 to 65 inches:* very gravelly sand

##### Properties and qualities

**Slope: 0 to 3 percent**

*Depth to restrictive feature:* More than 80 inches

*Drainage class:* Poorly drained

*Runoff class:* Very high

*Capacity of the most limiting layer to transmit water*

*(Ksat):* Moderately low to high (0.14 to 14.17 in/hr)

*Depth to water table:* About 0 to 4 inches

*Frequency of flooding:* None

*Frequency of ponding:* None

*Maximum salinity:* Nonsaline (0.0 to 1.9 mmhos/cm)

*Available water supply, 0 to 60 inches:* Moderate (about 6.4 inches)

### Interpretive groups

*Land capability classification (irrigated):* None specified

*Land capability classification (nonirrigated):* 4w

**Hydrologic Soil Group: B/D**

*Ecological site:* F144AY028MA - Wet Outwash

*Hydric soil rating:* Yes

### Minor Components

#### Sudbury

*Percent of map unit:* 10 percent

*Landform:* Outwash plains, deltas, terraces

*Landform position (two-dimensional):* Footslope

*Landform position (three-dimensional):* Tread, dip

*Down-slope shape:* Concave

*Across-slope shape:* Linear

*Hydric soil rating:* No

#### Scarboro

*Percent of map unit:* 10 percent

*Landform:* Outwash plains, deltas, outwash terraces

*Landform position (two-dimensional):* Toeslope

*Landform position (three-dimensional):* Tread, dip

*Down-slope shape:* Concave

*Across-slope shape:* Concave

*Hydric soil rating:* Yes

## Data Source Information

Soil Survey Area: State of Connecticut

Survey Area Data: Version 21, Sep 7, 2021

## State of Connecticut

### 15—Scarboro muck, 0 to 3 percent slopes

#### Map Unit Setting

*National map unit symbol:* 2svkt

*Elevation:* 0 to 1,350 feet

*Mean annual precipitation:* 36 to 71 inches

*Mean annual air temperature:* 39 to 55 degrees F

*Frost-free period:* 140 to 240 days

*Farmland classification:* Not prime farmland

#### Map Unit Composition

*Scarboro and similar soils:* 80 percent

*Minor components:* 20 percent

*Estimates are based on observations, descriptions, and transects of the mapunit.*

#### Description of Scarboro

##### Setting

*Landform:* Drainageways, depressions, outwash deltas, outwash terraces

*Landform position (two-dimensional):* Toeslope

*Landform position (three-dimensional):* Base slope, tread, dip

*Down-slope shape:* Concave

*Across-slope shape:* Linear, concave

*Parent material:* Sandy glaciofluvial deposits derived from schist and/or gneiss and/or granite

##### Typical profile

*Oa - 0 to 8 inches:* muck

*A - 8 to 14 inches:* mucky fine sandy loam

*Cg1 - 14 to 22 inches:* sand

*Cg2 - 22 to 65 inches:* gravelly sand

##### Properties and qualities

**Slope: 0 to 3 percent**

*Depth to restrictive feature:* More than 80 inches

*Drainage class:* Very poorly drained

*Runoff class:* Negligible

*Capacity of the most limiting layer to transmit water*

*(Ksat):* Moderately high to high (1.42 to 14.17 in/hr)

*Depth to water table:* About 0 to 2 inches

*Frequency of flooding:* None

*Frequency of ponding:* Frequent

*Maximum salinity:* Nonsaline (0.0 to 1.9 mmhos/cm)

*Available water supply, 0 to 60 inches:* Moderate (about 6.1 inches)

##### Interpretive groups

*Land capability classification (irrigated):* None specified

*Land capability classification (nonirrigated):* 5w

**Hydrologic Soil Group: A/D**

*Ecological site:* F144AYU31MA - Very Wet Outwash

*Hydric soil rating:* Yes

### Minor Components

#### Timakwa

*Percent of map unit:* 10 percent

*Landform:* Swamps

*Landform position (two-dimensional):* Toeslope

*Landform position (three-dimensional):* Base slope, tread, dip

*Down-slope shape:* Concave, linear

*Across-slope shape:* Concave, linear

*Hydric soil rating:* Yes

#### Walpole

*Percent of map unit:* 8 percent

*Landform:* Deltas, depressions, outwash plains, depressions, outwash terraces

*Landform position (two-dimensional):* Toeslope

*Landform position (three-dimensional):* Tread, talf, dip

*Down-slope shape:* Concave

*Across-slope shape:* Concave

*Hydric soil rating:* Yes

#### Deerfield

*Percent of map unit:* 2 percent

*Landform:* Terraces, outwash plains

*Landform position (three-dimensional):* Tread, dip

*Down-slope shape:* Linear

*Across-slope shape:* Concave

*Hydric soil rating:* No

## Data Source Information

Soil Survey Area: State of Connecticut

Survey Area Data: Version 21, Sep 7, 2021

## State of Connecticut

### 34B—Merrimac fine sandy loam, 3 to 8 percent slopes

#### Map Unit Setting

*National map unit symbol:* 2tyqs

*Elevation:* 0 to 1,290 feet

*Mean annual precipitation:* 36 to 71 inches

*Mean annual air temperature:* 39 to 55 degrees F

*Frost-free period:* 140 to 240 days

*Farmland classification:* All areas are prime farmland

#### Map Unit Composition

*Merrimac and similar soils:* 85 percent

*Minor components:* 15 percent

*Estimates are based on observations, descriptions, and transects of the mapunit.*

#### Description of Merrimac

##### Setting

*Landform:* Outwash plains, outwash terraces, moraines, eskers, kames

*Landform position (two-dimensional):* Summit, shoulder, backslope, footslope

*Landform position (three-dimensional):* Side slope, crest, riser, tread

*Down-slope shape:* Convex

*Across-slope shape:* Convex

*Parent material:* Loamy glaciofluvial deposits derived from granite, schist, and gneiss over sandy and gravelly glaciofluvial deposits derived from granite, schist, and gneiss

##### Typical profile

*Ap - 0 to 10 inches:* fine sandy loam

*Bw1 - 10 to 22 inches:* fine sandy loam

*Bw2 - 22 to 26 inches:* stratified gravel to gravelly loamy sand

*2C - 26 to 65 inches:* stratified gravel to very gravelly sand

##### Properties and qualities

**Slope: 3 to 8 percent**

*Depth to restrictive feature:* More than 80 inches

*Drainage class:* Somewhat excessively drained

*Runoff class:* Very low

*Capacity of the most limiting layer to transmit water*

*(Ksat):* Moderately high to very high (1.42 to 99.90 in/hr)

*Depth to water table:* More than 80 inches

*Frequency of flooding:* None

*Frequency of ponding:* None

*Calcium carbonate, maximum content:* 2 percent

*Maximum salinity:* Nonsaline (0.0 to 1.4 mmhos/cm)

*Sodium adsorption ratio, maximum:* 1.0

*Available water supply, 0 to 60 inches:* Low (about 4.6 inches)

### Interpretive groups

*Land capability classification (irrigated):* None specified

*Land capability classification (nonirrigated):* 2s

**Hydrologic Soil Group: A**

*Ecological site:* F145X1008MA - Dry Outwash

*Hydric soil rating:* No

### Minor Components

#### Sudbury

*Percent of map unit:* 5 percent

*Landform:* Deltas, terraces, outwash plains

*Landform position (two-dimensional):* Footslope

*Landform position (three-dimensional):* Tread, dip

*Down-slope shape:* Concave

*Across-slope shape:* Linear

*Hydric soil rating:* No

#### Hinckley

*Percent of map unit:* 5 percent

*Landform:* Deltas, kames, eskers, outwash plains

*Landform position (two-dimensional):* Summit, shoulder, backslope

*Landform position (three-dimensional):* Head slope, nose slope, side slope, crest, rise

*Down-slope shape:* Convex

*Across-slope shape:* Convex, linear

*Hydric soil rating:* No

#### Windsor

*Percent of map unit:* 3 percent

*Landform:* Outwash terraces, dunes, deltas, outwash plains

*Landform position (two-dimensional):* Shoulder

*Landform position (three-dimensional):* Tread, riser

*Down-slope shape:* Linear, convex

*Across-slope shape:* Linear, convex

*Hydric soil rating:* No

#### Agawam

*Percent of map unit:* 2 percent

*Landform:* Outwash plains, outwash terraces, moraines, stream terraces, eskers, kames

*Landform position (three-dimensional):* Rise

*Down-slope shape:* Convex

*Across-slope shape:* Convex

*Hydric soil rating:* No

## Data Source Information

Soil Survey Area: State of Connecticut

Survey Area Data: Version 21, Sep 7, 2021

## State of Connecticut

### 38E—Hinckley loamy sand, 15 to 45 percent slopes

#### Map Unit Setting

*National map unit symbol:* 2svmj

*Elevation:* 0 to 1,280 feet

*Mean annual precipitation:* 36 to 71 inches

*Mean annual air temperature:* 39 to 55 degrees F

*Frost-free period:* 140 to 240 days

*Farmland classification:* Not prime farmland

#### Map Unit Composition

*Hinckley and similar soils:* 85 percent

*Minor components:* 15 percent

*Estimates are based on observations, descriptions, and transects of the mapunit.*

#### Description of Hinckley

##### Setting

*Landform:* Eskers, kames, outwash deltas, outwash terraces, moraines, outwash plains, kame terraces

*Landform position (two-dimensional):* Backslope

*Landform position (three-dimensional):* Head slope, nose slope, side slope, crest, riser

*Down-slope shape:* Concave, convex, linear

*Across-slope shape:* Convex, linear, concave

*Parent material:* Sandy and gravelly glaciofluvial deposits derived from gneiss and/or granite and/or schist

##### Typical profile

*Oe - 0 to 1 inches:* moderately decomposed plant material

*A - 1 to 8 inches:* loamy sand

*Bw1 - 8 to 11 inches:* gravelly loamy sand

*Bw2 - 11 to 16 inches:* gravelly loamy sand

*BC - 16 to 19 inches:* very gravelly loamy sand

*C - 19 to 65 inches:* very gravelly sand

##### Properties and qualities

**Slope:** 15 to 45 percent

*Depth to restrictive feature:* More than 80 inches

*Drainage class:* Excessively drained

*Runoff class:* Low

*Capacity of the most limiting layer to transmit water*

*(Ksat):* Moderately high to very high (1.42 to 99.90 in/hr)

*Depth to water table:* More than 80 inches

*Frequency of flooding:* None

*Frequency of ponding:* None

*Maximum salinity:* Nonsaline (0.0 to 1.9 mmhos/cm)

*Available water supply, 0 to 60 inches:* Low (about 3.1 inches)

**Interpretive groups**

*Land capability classification (irrigated):* None specified

*Land capability classification (nonirrigated):* 7e

**Hydrologic Soil Group: A**

*Ecological site:* F144AY022MA - Dry Outwash

*Hydric soil rating:* No

**Minor Components****Windsor**

*Percent of map unit:* 5 percent

*Landform:* Eskers, kames, moraines, outwash deltas, outwash terraces, outwash plains, kame terraces

*Landform position (two-dimensional):* Backslope

*Landform position (three-dimensional):* Head slope, nose slope, side slope, crest, riser

*Down-slope shape:* Concave, convex, linear

*Across-slope shape:* Convex, linear, concave

*Hydric soil rating:* No

**Merrimac**

*Percent of map unit:* 5 percent

*Landform:* Outwash plains, outwash terraces, moraines, eskers, kames

*Landform position (two-dimensional):* Backslope

*Landform position (three-dimensional):* Head slope, nose slope, side slope, crest, riser

*Down-slope shape:* Convex

*Across-slope shape:* Convex

*Hydric soil rating:* No

**Agawam**

*Percent of map unit:* 3 percent

*Landform:* Eskers, kame terraces, outwash deltas, outwash terraces, moraines, kames, outwash plains

*Landform position (two-dimensional):* Backslope

*Landform position (three-dimensional):* Head slope, nose slope, side slope, crest, riser

*Down-slope shape:* Concave, convex, linear

*Across-slope shape:* Convex, linear, concave

*Hydric soil rating:* No

**Sudbury**

*Percent of map unit:* 2 percent

*Landform:* Kames, eskers, outwash deltas, outwash plains, kame terraces, outwash terraces, moraines

*Landform position (two-dimensional):* Backslope, footslope

*Landform position (three-dimensional):* Base slope, tread

*Down-slope shape:* Concave, linear

*Across-slope shape:* Linear, concave



*Hydric soil rating:* No

## Data Source Information

Soil Survey Area: State of Connecticut  
Survey Area Data: Version 21, Sep 7, 2021

## State of Connecticut

### 305—Udorthents-Pits complex, gravelly

#### Map Unit Setting

*National map unit symbol:* 9lmf  
*Elevation:* 0 to 2,000 feet  
*Mean annual precipitation:* 43 to 54 inches  
*Mean annual air temperature:* 45 to 55 degrees F  
*Frost-free period:* 120 to 185 days  
*Farmland classification:* Not prime farmland

#### Map Unit Composition

*Udorthents and similar soils:* 65 percent  
*Pits:* 25 percent  
*Minor components:* 10 percent  
*Estimates are based on observations, descriptions, and transects of the mapunit.*

#### Description of Udorthents

##### Setting

*Down-slope shape:* Convex  
*Across-slope shape:* Linear  
*Parent material:* Gravelly outwash

##### Typical profile

*A - 0 to 5 inches:* loam  
*C1 - 5 to 21 inches:* gravelly loam  
*C2 - 21 to 80 inches:* very gravelly sandy loam

##### Properties and qualities

*Slope:* 0 to 35 percent  
*Depth to restrictive feature:* More than 80 inches  
*Drainage class:* Moderately well drained  
*Runoff class:* Medium  
*Capacity of the most limiting layer to transmit water (Ksat):* Very low to high (0.00 to 1.98 in/hr)  
*Depth to water table:* About 24 to 54 inches  
*Frequency of flooding:* None  
*Frequency of ponding:* None  
*Available water supply, 0 to 60 inches:* Moderate (about 6.8 inches)

##### Interpretive groups

*Land capability classification (irrigated):* None specified  
*Land capability classification (nonirrigated):* 4e  
*Hydrologic Soil Group:* C  
*Hydric soil rating:* No

**Description of Pits****Typical profile**

*C - 0 to 65 inches: very gravelly sand*

**Interpretive groups**

*Land capability classification (irrigated): None specified*

*Land capability classification (nonirrigated): 8*

*Hydric soil rating: Unranked*

**Minor Components****Windsor**

*Percent of map unit: 2 percent*

*Landform: Terraces, outwash plains, kames*

*Down-slope shape: Convex*

*Across-slope shape: Convex*

*Hydric soil rating: No*

**Merrimac**

*Percent of map unit: 2 percent*

*Landform: Terraces, outwash plains, kames*

*Down-slope shape: Linear*

*Across-slope shape: Linear*

*Hydric soil rating: No*

**Hinckley**

*Percent of map unit: 2 percent*

*Landform: Terraces, outwash plains, kames, eskers*

*Down-slope shape: Convex*

*Across-slope shape: Convex*

*Hydric soil rating: No*

**Gloucester**

*Percent of map unit: 2 percent*

*Landform: Hills*

*Down-slope shape: Convex*

*Across-slope shape: Convex*

*Hydric soil rating: No*

**Sudbury**

*Percent of map unit: 1 percent*

*Landform: Terraces, outwash plains*

*Down-slope shape: Concave*

*Across-slope shape: Linear*

*Hydric soil rating: No*

**Ninigret**

*Percent of map unit: 1 percent*

*Landform: Terraces, outwash plains*

*Down-slope shape: Linear*

*Across-slope shape: Concave*

*Hydric soil rating:* No

## **Data Source Information**

Soil Survey Area: State of Connecticut  
Survey Area Data: Version 21, Sep 7, 2021

Water Quality Flow Calculations  
and  
Detention Facility Volumetric Capacity Calculations  
and Stage/Storage Relationships

Simsbury, Connecticut  
**Water Quality Volume Size Calculations**

December 17, 2021

**Minimum-Recommended Water Quality Volume (WQV)**

Watershed	Total Area (Ac) A	Impervious Area (Ac)	Impervious (%) I	Runoff (R)	Min. Rec. WQV (ac-ft)	Min. Rec. WQV (Cu.Ft.)
EAST DET. 1 (PRO)	1.32	0.55	41.4	0.4228	0.04637	2,020
EAST DET. 2 (PRO)	0.90	0.72	80.0	0.7699	0.05801	2,527
WEST DET. 1 (PRO)	0.39	0.35	89.7	0.8577	0.02761	1,203
WEST DET. 2 (PRO)	0.70	0.62	88.8	0.8488	0.04963	2,162

**Provided Water Quality Volume**

**Water Quality Basins**

Watershed	Elevations (Ft.)	Area (Sq. Ft.)	Avg. Area (Sq. Ft.)	Avg. Depth (FT)	Net. WQV (Cu. Ft.)	Total Provided WQV (Cu. Ft.)
WQ BASIN	211	404				2527
			559	1.00	559	
	212	713				
			908	1.00	908	
	213	1102				
	214	1550	1326	0.80	1061	

$$WQV = \frac{(1")(R)(A)}{12}$$

WQV = water quality volume (ac-ft)

R = volumetric runoff coefficient  
 0.05+0.009(I)

I = percent impervious cover

A= Site area (acres)

**DORSET CROSSING - CASTERBRIDGE CROSSING**  
Simsbury, Connecticut

12/17/2021

**U.G. Storage System #1**

Stage-Storage Relationship

Number of SC-740 Chambers = 18

Minimum-recommended Water Quality Volume = **1,203 CU FT**

WQV Provided within chamber system at beneath elevation 238.00:

Storage vol.@ el. 237.50 = **1,227 CU FT**

18 Chambers Provided: Total Storage = **1,348 CU FT**

Elevation	U.G. Chamber Storage Volume per LF (CU FT)	Chamber System Length (FT)	Incremental Storage Volume (CU FT)	Cumulative Storage Volume (CU FT)
	Stormceptor Units ***			
234.50	0.000	128	0	0
235.00	0.950	128	122	122
235.50	2.044	128	262	384
236.00	1.956	128	251	634
236.50	1.821	128	233	867
237.00	1.612	128	206	1074
237.50	1.192	128	153	1227
238.00	0.950	128	122	1348

Storage Vol. per Chamber (CU FT) *
0
6.76
21.31
35.23
48.19
59.66
68.14
74.9

\* see cut sheet for volumetric capacity of unit and stone fill

**DORSET CROSSING - CASTERBRIDGE CROSSING**  
Simsbury, Connecticut

12/17/2021

**U.G. Storage System #2**

Stage-Storage Relationship

Number of SC-740 Chambers = 30

Minimum-recommended Water Quality Volume = **2,162 CU FT**

WQV Provided within chamber system at beneath elevation 232.50:  
Storage vol.@ el. 233.00 = **2,247 CU FT**

30 Chambers Provided: Total Storage = **2,247 CU FT**

Elevation	U.G. Chamber Storage Volume per LF (CU FT)	Chamber System Length (FT)	Incremental Storage Volume (CU FT)	Cumulative Storage Volume (CU FT)
	Stormceptor Units ***			
229.50	0.000	214	0	0
230.00	0.950	214	203	203
230.50	2.044	214	437	639
231.00	1.956	214	418	1057
231.50	1.821	214	389	1446
232.00	1.612	214	344	1790
232.50	1.192	214	254	2044
233.00	0.950	214	203	2247

Storage Vol. per Chamber (CU FT) *
0
6.76
21.31
35.23
48.19
59.66
68.14
74.9

\* see cut sheet for volumetric capacity of unit and stone fill



**DORSET CROSSING - CASTERBRIDGE CROSSING**  
Simsbury, Connecticut

12/17/2021

**U.G. Storage System #3**

Stage-Storage Relationship

Number of SC-740 Chambers = 37

Minimum-recommended Water Quality Volume = **2,020 CU FT**

WQV Provided within chamber system at beneath elevation 228.00:  
Storage vol.@ el. 228.00 = **2,771 CU FT**

37 Chambers Provided: Total Storage = **2,771 CU FT**

Elevation	U.G. Chamber Storage Volume per LF (CU FT)	Chamber System Length (FT)	Incremental Storage Volume (CU FT)	Cumulative Storage Volume (CU FT)
	Stormceptor Units ***			
224.50	0.000	263	0	0
225.00	0.950	263	250	250
225.50	2.044	263	538	788
226.00	1.956	263	515	1304
226.50	1.821	263	480	1783
227.00	1.612	263	424	2207
227.50	1.192	263	314	2521
228.00	0.950	263	250	2771

Storage Vol. per Chamber (CU FT) *
0
6.76
21.31
35.23
48.19
59.66
68.14
74.9

\* see cut sheet for volumetric capacity of unit and stone fill

# STORMTECH SC-740 CHAMBER

Designed to meet the most stringent industry performance standards for superior structural integrity while providing designers with a cost-effective method to save valuable land and protect water resources. The StormTech system is designed primarily to be used under parking lots, thus maximizing land usage for private (commercial) and public applications. StormTech chambers can also be used in conjunction with Green Infrastructure, thus enhancing the performance and extending the service life of these practices.

## STORMTECH SC-740 CHAMBER (not to scale)

### Nominal Chamber Specifications

**Size (L x W x H)**  
85.4" x 51" x 30"  
2,170 mm x 1,295 mm x 762 mm

**Chamber Storage**  
45.9 ft<sup>3</sup> (1.30 m<sup>3</sup>)

**Min. Installed Storage\***  
74.9 ft<sup>3</sup> (2.12 m<sup>3</sup>)

**Weight**  
74.0 lbs (33.6 kg)

**Shipping**  
30 chambers/pallet  
60 end caps/pallet  
12 pallets/truck

\*Assumes 6" (150 mm) stone above, below and between chambers and 40% stone porosity.

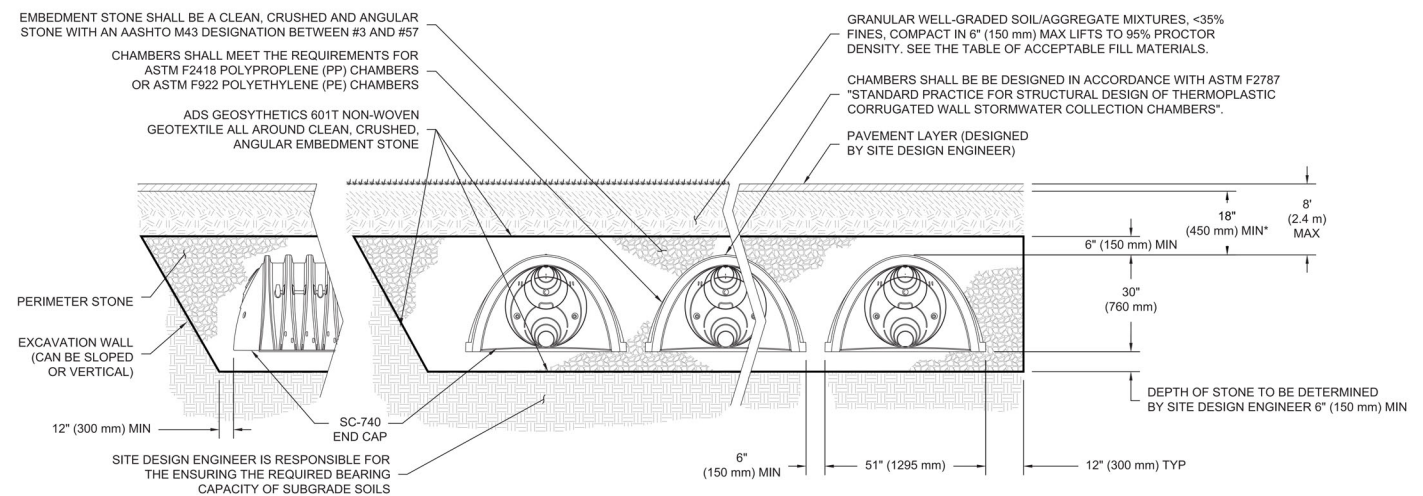
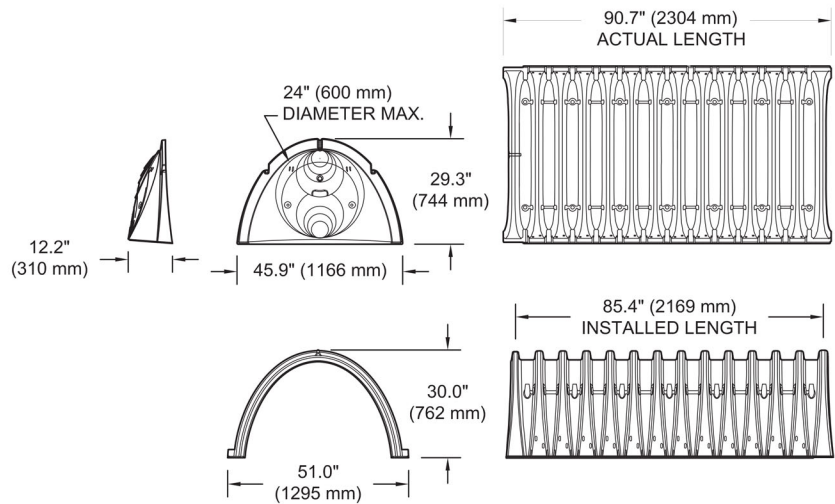
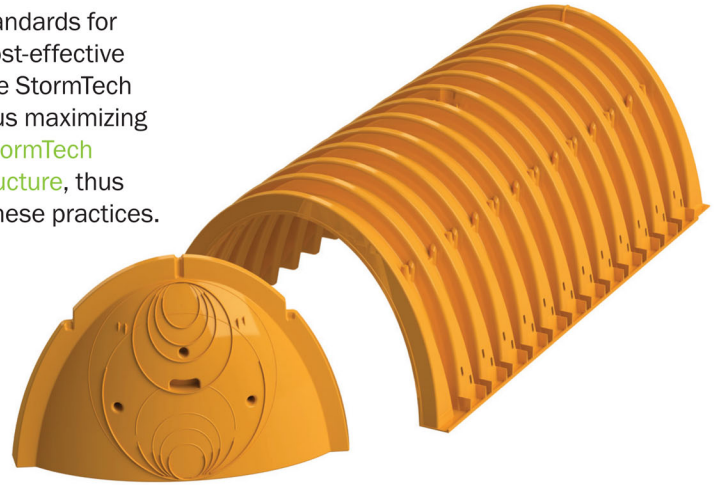

\*MINIMUM COVER TO BOTTOM OF FLEXIBLE PAVEMENT. FOR UNPAVED INSTALLATIONS WHERE RUTTING FROM VEHICLES MAY OCCUR, INCREASE COVER TO 24" (600 mm).

## SC-740 CUMULATIVE STORAGE VOLUMES PER CHAMBER

Assumes 40% Stone Porosity. Calculations are Based Upon a 6" (150 mm) Stone Base Under Chambers.

Depth of Water in System Inches (mm)	Cumulative Chamber Storage ft <sup>3</sup> (m <sup>3</sup> )	Total System Cumulative Storage ft <sup>3</sup> (m <sup>3</sup> )
42 (1067)	45.90 (1.300)	74.90 (2.121)
41 (1041)	45.90 (1.300)	73.77 (2.089)
40 (1016)	45.90 (1.300)	72.64 (2.057)
39 (991)	45.90 (1.300)	71.52 (2.025)
38 (965)	45.90 (1.300)	70.39 (1.993)
37 (940)	45.90 (1.300)	69.26 (1.961)
36 (914)	45.90 (1.300)	68.14 (1.929)
35 (889)	45.85 (1.298)	66.98 (1.897)
34 (864)	45.69 (1.294)	65.75 (1.862)
33 (838)	45.41 (1.286)	64.46 (1.825)
32 (813)	44.81 (1.269)	62.97 (1.783)
31 (787)	44.01 (1.246)	61.36 (1.737)
30 (762)	43.06 (1.219)	59.66 (1.689)
29 (737)	41.98 (1.189)	57.89 (1.639)
28 (711)	40.80 (1.155)	56.05 (1.587)
27 (686)	39.54 (1.120)	54.17 (1.534)
26 (660)	38.18 (1.081)	52.23 (1.479)
25 (635)	36.74 (1.040)	50.23 (1.422)
24 (610)	35.22 (0.977)	48.19 (1.365)
23 (584)	33.64 (0.953)	46.11 (1.306)
22 (559)	31.99 (0.906)	44.00 (1.246)
21 (533)	30.29 (0.858)	4.185 (1.185)
20 (508)	28.54 (0.808)	39.67 (1.123)
19 (483)	26.74 (0.757)	37.47 (1.061)
18 (457)	24.89 (0.705)	35.23 (0.997)
17 (432)	23.00 (0.651)	32.96 (0.939)
16 (406)	21.06 (0.596)	30.68 (0.869)
15 (381)	19.09 (0.541)	28.36 (0.803)
14 (356)	17.08 (0.484)	26.03 (0.737)
13 (330)	15.04 (0.426)	23.68 (0.670)
12 (305)	12.97 (0.367)	21.31 (0.608)
11 (279)	10.87 (0.309)	18.92 (0.535)
10 (254)	8.74 (0.247)	16.51 (0.468)
9 (229)	6.58 (0.186)	14.09 (0.399)
8 (203)	4.41 (0.125)	11.66 (0.330)
7 (178)	2.21 (0.063)	9.21 (0.264)
6 (152)	0 (0)	6.76 (0.191)
5 (127)	0 (0)	5.63 (0.160)
4 (102)	0 (0)	4.51 (0.128)
3 (76)	0 (0)	3.38 (0.096)
2 (51)	0 (0)	2.25 (0.064)
1 (25)	0 (0)	1.13 (0.032)

Note: Add 1.13 ft<sup>3</sup> (0.032 m<sup>3</sup>) of storage for each additional inch (25 mm) of stone foundation.

## STORAGE VOLUME PER CHAMBER FT<sup>3</sup> (M<sup>3</sup>)

	Bare Chamber Storage ft <sup>3</sup> (m <sup>3</sup> )	Chamber and Stone Foundation Depth in. (mm)		
		6 (150)	12 (300)	18 (450)
SC-740 Chamber	45.9 (1.3)	74.9 (2.1)	81.7 (2.3)	88.4 (2.5)

Note: Assumes 6" (150 mm) stone above chambers, 6" (150 mm) row spacing and 40% stone porosity.

## AMOUNT OF STONE PER CHAMBER

ENGLISH TONS (yds <sup>3</sup> )	Stone Foundation Depth		
	6"	12"	16"
SC-740	3.8 (2.8)	4.6 (3.3)	5.5 (3.9)
METRIC KILOGRAMS (m <sup>3</sup> )	150 mm	300 mm	450 mm
SC-740	3,450 (2.1)	4,170 (2.5)	4,490 (3.0)

Note: Assumes 6" (150 mm) of stone above and between chambers.

## VOLUME EXCAVATION PER CHAMBER YD<sup>3</sup> (M<sup>3</sup>)

	Stone Foundation Depth		
	6 (150)	12 (300)	18 (450)
SC-740	5.5 (4.2)	6.2 (4.7)	6.8 (5.2)

Note: Assumes 6" (150 mm) of row separation and 18" (450 mm) of cover. The volume of excavation will vary as depth of cover increases.



Working on a project?  
Visit us at [www.stormtech.com](http://www.stormtech.com)  
and utilize the StormTech Design Tool

For more information on the StormTech SC-740 Chamber and other ADS products, please contact our Customer Service Representatives at 1-800-821-6710

THE MOST **ADVANCED** NAME IN WATER MANAGEMENT SOLUTIONS™

Advanced Drainage Systems, Inc.  
4640 Trueman Blvd., Hilliard, OH 43026  
1-800-821-6710 [www.ads-pipe.com](http://www.ads-pipe.com)

Pipe to Pipe  
Hydraulic Analysis

12/17/2021

**DORSET CROSSING - CASTERBRIDGE CROSSING**  
 Simsbury, Connecticut  
**Pipe To Pipe Analysis**  
**Catchment Areas Summary**

EXISTING	Woods	Landscape	Paved/Roof	Total	Woods	Landscape	Paved/Roof	Total	Woods	Landscape	Paved/Roof	Total
Structure #	Area (S.F.)	Area (S.F.)	Area (S.F.)	Area (S.F.)	Area (S.F.)	Area (S.F.)	Area (S.F.)	Area (S.F.)	Area (Acre)	Area (S.F.)	Area (Acre)	Area (Acre)
CB2	0	7880	7659	15539	0.00	0.18	0.18	0.36	0.00	0.18	0.18	0.36
CB3	0	92	806	898	0.00	0.00	0.02	0.02	0.00	0.00	0.02	0.02
CB5	0	1605	0	1605	0.00	0.04	0.00	0.04	0.00	0.04	0.00	0.04
CB6	5947	1505	0	7452	0.14	0.03	0.00	0.17	0.14	0.03	0.00	0.17
CB7	16699	12007	0	28706	0.38	0.28	0.00	0.66	0.38	0.28	0.00	0.66
CB8A	0	1324	5043	6367	0.00	0.03	0.12	0.15	0.00	0.03	0.12	0.15
CB12A	0	511	8100	8611	0.00	0.01	0.19	0.20	0.00	0.01	0.19	0.20
CB13A	0	708	4736	5444	0.00	0.02	0.11	0.12	0.00	0.02	0.11	0.12
CB19	0	2634	0	2634	0.00	0.06	0.00	0.06	0.00	0.06	0.00	0.06
CB22A	0	388	5798	6186	0.00	0.01	0.13	0.14	0.00	0.01	0.13	0.14
CB23A	0	2331	12470	14801	0.00	0.05	0.29	0.34	0.00	0.05	0.29	0.34
CB24	0	2943	1896	4839	0.00	0.07	0.04	0.11	0.00	0.07	0.04	0.11
CB25	0	1034	1490	2524	0.00	0.02	0.03	0.06	0.00	0.02	0.03	0.06
CB26	0	1637	494	2131	0.00	0.04	0.01	0.05	0.00	0.04	0.01	0.05
CB27	10394	7593	1195	19182	0.24	0.17	0.03	0.44	0.24	0.17	0.03	0.44
CB29	2172	2986	0	5158	0.05	0.07	0.00	0.12	0.05	0.07	0.00	0.12
CB30	1304	2489	0	3793	0.03	0.06	0.00	0.09	0.03	0.06	0.00	0.09
CB31	8579	2538	1424	12541	0.20	0.06	0.03	0.29	0.20	0.06	0.03	0.29
RL 'A'	0	0	19624	19624	0.00	0.00	0.45	0.45	0.00	0.00	0.45	0.45
RL 'B'	0	0	26933	26933	0.00	0.00	0.62	0.62	0.00	0.00	0.62	0.62
TD10A	0	2107	2450	4557	0.00	0.05	0.06	0.10	0.00	0.05	0.06	0.10
TD13B	0	294	2103	2397	0.00	0.01	0.05	0.06	0.00	0.01	0.05	0.06
TD20A	0	3280	2280	5560	0.00	0.08	0.05	0.13	0.00	0.08	0.05	0.13

# STORM DRAINAGE SYSTEM DESIGN COMPUTATION SHEET

**F. A. Hesketh & Associates, Inc.**

JOB: 04174 - CASTERBRIDGE CROSSING

Civil & Traffic Engineers - Surveyors

CALCULATED BY:    DRT    DATE: DECEMBER 17, 2021

Planners - Landscape Architects

CHECKED BY:            CHECKED BY:                            DATE:                   

## PIPE TO PIPE ANALYSIS - CASTERBRIDGE Catchment Areas Weighted Runoff Coefficient Calculations

COVER CONDITION	WOODS		LANDSCAPED		IMPERVIOUS		TOTAL		
RUNOFF 'C'	C <sub>1</sub> =0.30		C <sub>2</sub> =0.15		C <sub>3</sub> =0.90				
DRAINAGE AREA (Ac.)	A <sub>1</sub>	(AxC) <sub>1</sub>	A <sub>3</sub>	(AxC) <sub>3</sub>	A <sub>3</sub>	(AxC) <sub>3</sub>	A	AxC	C
CB2	0.000	0.000	0.181	0.027	0.176	0.158	0.357	0.185	0.520
CB3	0.000	0.000	0.002	0.000	0.019	0.017	0.021	0.017	0.823
CB5	0.000	0.000	0.037	0.006	0.000	0.000	0.037	0.006	0.150
CB6	0.137	0.041	0.035	0.005	0.000	0.000	0.171	0.046	0.270
CB7	0.383	0.115	0.276	0.041	0.000	0.000	0.659	0.156	0.237
CB8A	0.000	0.000	0.030	0.005	0.116	0.104	0.146	0.109	0.744
CB12A	0.000	0.000	0.012	0.002	0.186	0.167	0.198	0.169	0.855
CB13A	0.000	0.000	0.016	0.002	0.109	0.098	0.125	0.100	0.802
CB19	0.000	0.000	0.060	0.009	0.000	0.000	0.060	0.009	0.150
CB22A	0.000	0.000	0.009	0.001	0.133	0.120	0.142	0.121	0.853
CB23A	0.000	0.000	0.054	0.008	0.286	0.258	0.340	0.266	0.782
CB24	0.000	0.000	0.068	0.010	0.044	0.039	0.111	0.049	0.444
CB25	0.000	0.000	0.024	0.004	0.034	0.031	0.058	0.034	0.593
CB26	0.000	0.000	0.038	0.006	0.011	0.010	0.049	0.016	0.324
CB27	0.239	0.072	0.174	0.026	0.027	0.025	0.440	0.122	0.278
CB29	0.050	0.015	0.069	0.010	0.000	0.000	0.118	0.025	0.213
CB30	0.030	0.009	0.057	0.009	0.000	0.000	0.087	0.018	0.202
CB31	0.197	0.059	0.058	0.009	0.033	0.029	0.288	0.097	0.338
RL 'A'	0.000	0.000	0.000	0.000	0.451	0.405	0.451	0.405	0.900
RL 'B'	0.000	0.000	0.000	0.000	0.618	0.556	0.618	0.556	0.900
TD10A	0.000	0.000	0.048	0.007	0.056	0.051	0.105	0.058	0.553
TD13B	0.000	0.000	0.007	0.001	0.048	0.043	0.055	0.044	0.808
TD20A	0.000	0.000	0.075	0.011	0.052	0.047	0.128	0.058	0.458

# Hydraflow Storm Sewers Plan

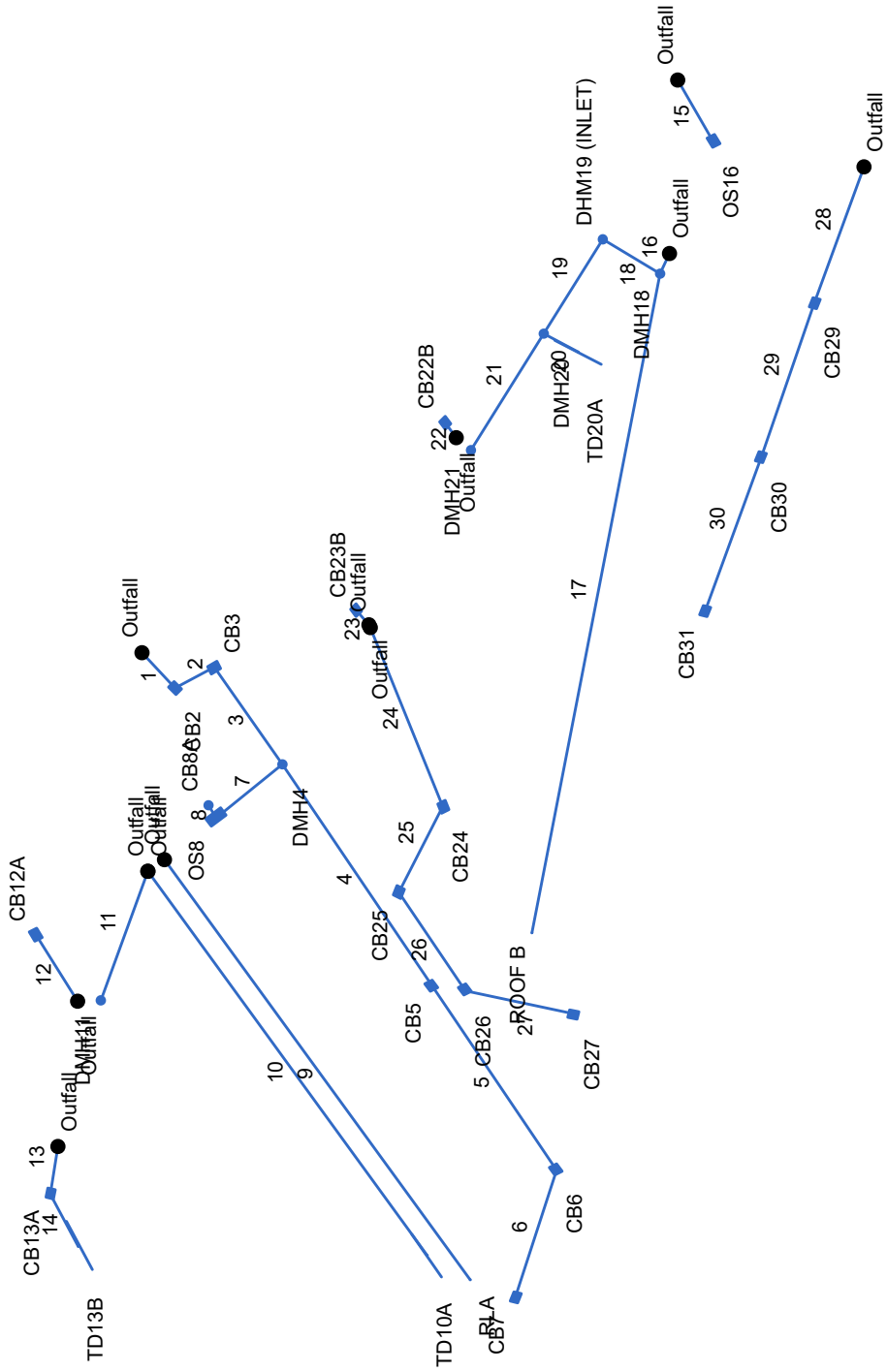

# Storm Sewer Tabulation

Station	Len (ft)	Drng Area		Rnoff coeff (C)	Area x C		Tc		Rain (l) (in/hr)	Total flow (cfs)	Cap full (cfs)	Vel (ft/s)	Pipe		Invert Elev		HGL Elev		Grnd / Rim Elev		Line ID	
		Incr (ac)	Total (ac)		Incr	Total	Inlet (min)	Syst (min)					Size (in)	Slope (%)	Dn (ft)	Up (ft)	Dn (ft)	Up (ft)	Dn (ft)	Up (ft)		
1	End	26	0.36	1.40	0.52	0.19	0.52	5.0	7.8	7.3	3.85	4.57	4.17	15	0.50	228.00	228.13	228.88	229.01	229.50	234.76	FES1-CB2
2	1	24	0.02	1.04	0.34	0.02	0.34	5.0	7.7	7.4	2.50	4.95	2.04	15	0.50	228.13	228.25	229.61	229.64	234.76	234.76	CB2-CB3
3	2	64	0.00	1.02	0.32	0.00	0.32	0.0	7.2	7.6	2.45	4.95	2.00	15	0.50	228.25	228.57	229.74	229.82	234.76	236.32	CB3-DMH4
4	3	144	0.04	0.87	0.21	0.01	0.21	5.0	6.3	8.1	1.71	15.45	2.45	15	4.87	228.57	235.59	229.91	236.11	236.32	240.00	DMH4-CB5
5	4	120	0.17	0.83	0.27	0.05	0.20	5.0	5.5	8.6	1.77	13.99	3.06	15	4.00	235.59	240.39	236.27	240.92	240.00	244.80	CB5-CB6
6	5	72	0.66	0.66	0.24	0.16	0.16	5.0	5.0	9.0	1.42	2.73	3.51	12	0.50	240.64	241.00	241.15	241.51	244.80	244.00	CB6-CB7
7	3	46	0.00	0.15	0.00	0.00	0.11	5.0	5.1	8.9	0.99	4.95	0.83	15	0.50	228.57	228.80	229.93	229.94	236.32	236.85	DMH4-OS8
8	7	8	0.15	0.15	0.11	0.11	0.11	5.0	5.0	9.0	1.00	3.86	3.46	12	1.00	234.01	234.09	234.36	234.55	236.85	236.59	OS8-CB8A
9	End	280	0.45	0.45	0.41	0.41	0.41	6.0	6.0	8.3	3.37	3.86	5.13	12	1.00	231.19	234.00	231.97	234.78	236.00	236.00	DMH9-RLA
10	End	256	0.11	0.11	0.06	0.06	0.06	5.0	5.0	9.0	0.54	1.31	2.94	8	1.00	231.44	234.00	231.79	234.35	239.04	235.90	DMH10-TD10A
11	End	74	0.00	0.00	0.00	0.00	0.00	10.0	10.0	0.0	3.00	12.12	4.29	15	3.00	235.78	238.00	236.47	238.69	239.04	241.49	DMH10-DMH11
12	End	42	0.20	0.20	0.17	0.17	0.17	5.0	5.0	9.0	1.54	3.86	3.67	12	1.00	236.68	237.10	237.21	237.63	241.42	239.60	DMH12-CB12B
13	End	26	0.13	0.19	0.15	0.10	0.15	5.0	5.2	8.8	1.35	3.86	3.50	12	1.00	237.24	237.50	237.73	237.99	241.40	241.84	DMH13-CB13A
14	13	32	0.06	0.06	0.05	0.05	0.05	5.0	5.0	9.0	0.44	2.27	3.87	8	3.00	238.04	239.00	238.24	239.31	241.84	241.85	CB13A-TD13B
15	End	38	0.00	0.00	0.00	0.00	0.00	5.0	5.0	0.0	6.00	7.00	5.81	15	1.00	209.00	209.38	209.98	210.36	210.75	214.00	FES15-OS16
16	End	12	0.00	0.81	0.00	0.00	0.63	0.0	8.4	7.1	7.64	7.82	6.68	15	1.25	216.00	216.15	217.10	217.25	225.00	225.10	WP17-DMH18
17	16	362	0.62	0.62	0.56	0.56	0.56	6.0	6.0	8.3	4.64	3.86	5.90	12	1.00	220.88	224.50	221.88	227.11	225.10	226.50	DMH18-RLB
18	16	36	0.06	0.19	0.15	0.01	0.07	5.0	6.5	8.0	3.75	9.89	5.86	15	2.00	219.84	220.56	220.37	221.41	225.10	224.50	DMH18-DMH19
19	18	60	0.00	0.13	0.00	0.00	0.06	0.0	6.1	8.2	3.69	15.64	3.84	15	5.00	220.56	223.56	221.96	224.33	224.50	228.00	DMH19-DMH20
20	19	21	0.13	0.13	0.06	0.06	0.06	6.0	6.0	8.3	0.50	1.31	2.84	8	1.00	224.30	224.51	224.64	224.84	228.00	226.50	DMH20-TD20A
21	19	74	0.00	0.00	0.00	0.00	0.00	0.0	0.0	0.0	3.20	17.14	3.72	15	6.00	223.56	228.00	224.56	228.72	228.00	231.55	DMH20-DMH21
22	End	10	0.14	0.14	0.12	0.12	0.12	5.0	5.0	9.0	1.07	3.86	3.22	12	1.00	227.83	227.93	228.27	228.37	231.26	230.43	DMH22-CB22A
23	End	10	0.34	0.34	0.27	0.27	0.27	5.0	5.0	9.0	2.38	3.86	4.36	12	1.00	230.18	230.28	230.83	230.94	233.40	232.78	DMH23-CB23A

Project File: 2021-12-17 Model.stm

Number of lines: 30

Run Date: 12-17-2021

NOTES: Intensity = 43.38 / (Inlet time + 3.80) ^ 0.72; Return period = 25 Yrs. ; c = cir e = ellip b = box



# Storm Sewer Tabulation

Station Line	To Line	Len (ft)	Drng Area		Rnoff coeff (C)	Area x C		Tc		Rain (l) (in/hr)	Total flow (cfs)	Cap full (cfs)	Vel (ft/s)	Pipe		Invert Elev		HGL Elev		Grnd / Rim Elev		Line ID
			Incr (ac)	Total (ac)		Incr	Total	Inlet (min)	Syst (min)					Size (in)	Slope (%)	Dn (ft)	Up (ft)	Dn (ft)	Up (ft)	Dn (ft)	Up (ft)	
24	End	104	0.11	0.66	0.44	0.05	0.22	5.0	6.2	8.2	1.83	7.00	3.59	15	1.00	229.83	230.87	230.37	231.41	233.40	235.28	DMH23-CB24
25	24	52	0.06	0.55	0.59	0.04	0.17	5.0	5.8	8.4	1.47	2.73	3.54	12	0.50	231.12	231.38	231.64	231.90	235.28	235.00	CB24-CB25
26	25	64	0.05	0.49	0.32	0.02	0.14	5.0	5.4	8.7	1.21	2.73	2.21	12	0.50	231.38	231.70	232.21	232.26	235.00	234.50	CB25-CB26
27	26	60	0.44	0.44	0.28	0.12	0.12	5.0	5.0	9.0	1.11	2.73	2.22	12	0.50	231.70	232.00	232.46	232.51	234.50	234.50	CB26-CB27
28	End	78	0.12	0.50	0.21	0.03	0.14	5.0	6.2	8.2	1.16	5.10	3.31	12	2.05	214.50	216.10	214.96	216.56	216.50	221.50	FES28-CB29
29	28	88	0.09	0.38	0.20	0.02	0.12	5.0	5.6	8.6	1.00	8.63	2.58	12	5.00	216.10	220.50	216.70	220.92	221.50	226.50	CB29-CB30
30	29	88	0.29	0.29	0.34	0.10	0.10	5.0	5.0	9.0	0.89	10.91	2.49	12	8.00	220.50	227.54	221.06	227.94	226.50	234.50	CB30-CB31

Project File: 2021-12-17 Model.stm

Number of lines: 30

Run Date: 12-17-2021

NOTES: Intensity = 43.38 / (Inlet time + 3.80) ^ 0.72; Return period = 25 Yrs. ; c = cir e = ellip b = box

# Storm Sewer Summary Report

Line No.	Line ID	Flow rate (cfs)	Line size (in)	Line shape	Line length (ft)	Invert EL Dn (ft)	Invert EL Up (ft)	Line slope (%)	HGL down (ft)	HGL up (ft)	Minor loss (ft)	HGL Junct (ft)	Dns line No.	Junction Type
1	FES1-CB2	3.85	15	Cir	26	228.00	228.13	0.500	228.88	229.01	0.40	229.41	End	Combination
2	CB2-CB3	2.50	15	Cir	24	228.13	228.25	0.500	229.61*	229.64*	0.10	229.74	1	Combination
3	CB3-DMH4	2.45	15	Cir	64	228.25	228.57	0.500	229.74	229.82	0.06	229.88	2	Manhole
4	DMH4-CB5	1.71	15	Cir	144	228.57	235.59	4.875	229.91	236.11	n/a	236.11 j	3	Grate
5	CB5-CB6	1.77	15	Cir	120	235.59	240.39	4.000	236.27	240.92	n/a	240.92 j	4	Grate
6	CB6-CB7	1.42	12	Cir	72	240.64	241.00	0.500	241.15	241.51	n/a	241.70 j	5	Grate
7	DMH4-OS8	0.99	15	Cir	46	228.57	228.80	0.500	229.93	229.94	0.01	229.95	3	Manhole
8	OS8-CB8A	1.00	12	Cir	8	234.01	234.09	1.000	234.36	234.55	0.12	234.68	7	Combination
9	DMH9-RLA	3.37	12	Cir	280	231.19	234.00	1.004	231.97	234.78	n/a	234.78 j	End	None
10	DMH10-TD10A	0.54	8	Cir	256	231.44	234.00	1.000	231.79	234.35	n/a	234.35 j	End	Grate
11	DMH10-DMH11	3.00	15	Cir	74	235.78	238.00	3.000	236.47	238.69	n/a	238.69	End	Manhole
12	DMH12-CB12B	1.54	12	Cir	42	236.68	237.10	1.000	237.21	237.63	n/a	237.63 j	End	Combination
13	DMH13-CB13A	1.35	12	Cir	26	237.24	237.50	1.000	237.73	237.99	n/a	237.99	End	Grate
14	CB13A-TD13B	0.44	8	Cir	32	238.04	239.00	3.000	238.24	239.31	0.12	239.31	13	Grate
15	FES15-OS16	6.00	15	Cir	38	209.00	209.38	1.000	209.98	210.36	0.53	210.36	End	Grate
16	WP17-DMH18	7.64	15	Cir	12	216.00	216.15	1.250	217.10	217.25	0.69	217.94	End	Manhole
17	DMH18-RLB	4.64	12	Cir	362	220.88	224.50	1.000	221.88*	227.11*	0.54	227.65	16	None
18	DMH18-DMH19	3.75	15	Cir	36	219.84	220.56	2.000	220.37	221.41	0.41	221.83	16	Grate
19	DMH19-DMH20	3.69	15	Cir	60	220.56	223.56	5.000	221.96	224.33	n/a	224.33 j	18	Manhole
20	DMH20-TD20A	0.50	8	Cir	21	224.30	224.51	1.000	224.64	224.84	n/a	224.84 j	19	Grate
21	DMH20-DMH21	3.20	15	Cir	74	223.56	228.00	6.000	224.56	228.72	n/a	228.72 j	19	Manhole
22	DMH22-CB22A	1.07	12	Cir	10	227.83	227.93	1.000	228.27	228.37	n/a	228.37 j	End	Combination
23	DMH23-CB23A	2.38	12	Cir	10	230.18	230.28	1.000	230.83	230.94	0.29	231.23	End	Combination
24	DMH23-CB24	1.83	15	Cir	104	229.83	230.87	1.000	230.37	231.41	0.24	231.41	End	Combination

Project File: 2021-12-17 Model.stm  
 Number of lines: 30  
 Run Date: 12-17-2021

NOTES: Return period = 25 Yrs. ; \*Surcharged (HGL above crown). ; j - Line contains hyd. jump.

# Storm Sewer Summary Report

Line No.	Line ID	Flow rate (cfs)	Line size (in)	Line shape	Line length (ft)	Invert EL Dn (ft)	Invert EL Up (ft)	Line slope (%)	HGL down (ft)	HGL up (ft)	Minor loss (ft)	HGL Junct (ft)	Dns line No.	Junction Type
25	CB24-CB25	1.47	12	Cir	52	231.12	231.38	0.500	231.64	231.90	n/a	232.16 j	24	Grate
26	CB25-CB26	1.21	12	Cir	64	231.38	231.70	0.500	232.21	232.26	0.12	232.38	25	Grate
27	CB26-CB27	1.11	12	Cir	60	231.70	232.00	0.500	232.46	232.51	0.12	232.63	26	Grate
28	FES28-CB29	1.16	12	Cir	78	214.50	216.10	2.051	214.96	216.56	n/a	216.56 j	End	Grate
29	CB29-CB30	1.00	12	Cir	88	216.10	220.50	5.000	216.70	220.92	n/a	220.92 j	28	Grate
30	CB30-CB31	0.89	12	Cir	88	220.50	227.54	8.000	221.06	227.94	n/a	227.94 j	29	Grate
Project File: 2021-12-17 Model.stm										Number of lines: 30		Run Date: 12-17-2021		

NOTES: Return period = 25 Yrs. ; \*Surcharged (HGL above crown). ; j - Line contains hyd. jump.

# Inlet Report

Line No	Inlet ID	Q = CIA (cfs)	Q carry (cfs)	Q capt (cfs)	Q byp (cfs)	Junc type	Curb Inlet		Grate Inlet			Gutter							Inlet			Byp line No
							Ht (in)	L (ft)	area (sqft)	L (ft)	W (ft)	So (ft/ft)	W (ft)	Sw (ft/ft)	Sx (ft/ft)	n	Depth (ft)	Spread (ft)	Depth (ft)	Spread (ft)	Depth (ft)	
1	CB2	1.68	0.00	1.68	0.00	Comb	3.0	3.00	3.13	2.73	1.63	Sag	2.00	0.030	0.030	0.000	0.04	1.44	0.21	1.85	2.0	Off
2	CB3	0.15	0.00	0.15	0.00	Comb	3.0	3.00	3.13	2.73	1.63	Sag	2.00	0.030	0.030	0.000	-0.12	-3.89	0.05	0.44	2.0	Off
3	DMH4	0.00	0.00	0.00	0.00	MH	0.0	0.00	0.00	0.00	0.00	Sag	0.00	0.000	0.000	0.000	0.00	0.00	0.00	0.00	0.0	Off
4	CB5	0.05	0.00	0.05	0.00	Grate	0.0	0.00	3.13	2.73	1.63	Sag	2.00	0.030	0.030	0.000	-0.15	-4.86	0.02	0.18	2.0	Off
5	CB6	0.41	0.00	0.41	0.00	Grate	0.0	0.00	3.13	2.73	1.63	Sag	2.00	0.030	0.030	0.000	-0.09	-2.87	0.08	0.71	2.0	Off
6	CB7	1.42	0.00	1.42	0.00	Grate	0.0	0.00	3.13	2.73	1.63	Sag	2.00	0.030	0.030	0.000	0.02	0.59	0.18	1.63	2.0	Off
7	OS8	0.00	0.00	0.00	0.00	MH	0.0	0.00	0.00	0.00	0.00	Sag	0.00	0.000	0.000	0.000	0.00	0.00	0.00	0.00	0.0	Off
8	CB8A	1.00	0.00	1.00	0.00	Comb	3.0	3.00	3.13	2.73	1.63	Sag	2.00	0.030	0.030	0.000	-0.02	-0.56	0.15	1.32	2.0	Off
9	RLA	3.37	0.00	0.00	3.37	None	0.0	0.00	0.00	0.00	0.00	Sag	0.00	0.000	0.000	0.000	0.00	0.00	0.00	0.00	0.0	Off
10	TD10A	0.54	0.00	0.54	0.00	Grate	0.0	0.00	3.13	2.73	1.63	Sag	2.00	0.030	0.030	0.000	-0.07	-2.32	0.10	0.86	2.0	Off
11	DMH11	3.00*	0.00	0.00	3.00	MH	0.0	0.00	0.00	0.00	0.00	Sag	0.00	0.000	0.000	0.000	0.00	0.00	0.00	0.00	0.0	Off
12	CB12A	1.54	0.00	1.54	0.00	Comb	3.0	3.00	3.13	2.73	1.63	Sag	2.00	0.030	0.030	0.000	0.03	1.11	0.20	1.76	2.0	Off
13	CB13A	0.93	0.00	0.93	0.00	Grate	0.0	0.00	3.13	2.73	1.63	Sag	2.00	0.030	0.030	0.000	-0.03	-0.92	0.14	1.23	2.0	Off
14	TD13B	0.44	0.00	0.44	0.00	Grate	0.0	0.00	3.13	2.73	1.63	Sag	2.00	0.030	0.030	0.000	-0.08	-2.76	0.08	0.74	2.0	Off
15	OS16	6.00*	0.00	6.00	0.00	Grate	0.0	0.00	3.13	2.73	1.63	Sag	2.00	0.030	0.030	0.000	0.31	10.48	0.48	10.48	2.0	Off
16	DMH18	0.00	0.00	0.00	0.00	MH	0.0	0.00	0.00	0.00	0.00	Sag	0.00	0.000	0.000	0.000	0.00	0.00	0.00	0.00	0.0	Off
17	ROOF B	4.64	0.00	0.00	4.64	None	0.0	0.00	0.00	0.00	0.00	Sag	0.00	0.000	0.000	0.000	0.00	0.00	0.00	0.00	0.0	Off
18	DHM19 (INLET)	0.08	0.00	0.08	0.00	Grate	0.0	0.00	0.78	1.00	1.00	Sag	2.00	0.030	0.030	0.000	-0.12	-4.12	0.04	0.38	2.0	Off
19	DMH20	0.00	0.00	0.00	0.00	MH	0.0	0.00	0.00	0.00	0.00	Sag	0.00	0.000	0.000	0.000	0.00	0.00	0.00	0.00	0.0	Off
20	TD20A	0.50	0.00	0.50	0.00	Grate	0.0	0.00	3.13	2.73	1.63	Sag	2.00	0.030	0.030	0.000	-0.08	-2.51	0.09	0.81	2.0	Off
21	DMH21	3.20*	0.00	0.00	3.20	MH	0.0	0.00	0.00	0.00	0.00	Sag	0.00	0.000	0.000	0.000	0.00	0.00	0.00	0.00	0.0	Off
22	CB22B	1.07	0.00	1.07	0.00	Comb	3.0	3.00	3.13	2.73	1.63	Sag	2.00	0.030	0.030	0.000	-0.01	-0.22	0.16	1.41	2.0	Off
23	CB23B	2.38	0.00	2.38	0.00	Comb	3.0	3.00	3.13	2.73	1.63	Sag	2.00	0.030	0.030	0.000	0.09	3.11	0.26	3.11	2.0	Off

Project File: 2021-12-17 Model.stm

Number of lines: 30

Run Date: 12-17-2021

NOTES: inlet N-Values = 0.016 ; intensity = 43.38 / (inlet time + 3.80) ^ 0.72; Return period = 25 Yrs. ; \* Indicates Known Q added. All curb inlets are Horiz throat.

# Inlet Report

Line No	Inlet ID	Q = CIA (cfs)	Q carry (cfs)	Q capt (cfs)	Q byp (cfs)	Junc type	Curb Inlet		Grate Inlet			Gutter							Inlet			Byp line No
							Ht (in)	L (ft)	area (sqft)	L (ft)	W (ft)	So (ft/ft)	W (ft)	Sw (ft/ft)	Sx (ft/ft)	n	Depth (ft)	Spread (ft)	Depth (ft)	Spread (ft)	Depth (ft)	
24	CB24	0.43	0.00	0.43	0.00	Comb	3.0	3.00	3.13	2.73	1.63	2.00	0.030	0.030	0.000	-0.08	-2.56	0.09	0.79	2.0	Off	
25	CB25	0.32	0.00	0.32	0.00	Grate	0.0	0.00	3.13	2.73	1.63	2.00	0.030	0.030	0.000	-0.10	-3.30	0.07	0.60	2.0	Off	
26	CB26	0.14	0.00	0.14	0.00	Grate	0.0	0.00	3.13	2.73	1.63	2.00	0.030	0.030	0.000	-0.13	-4.22	0.04	0.35	2.0	Off	
27	CB27	1.11	0.00	1.11	0.00	Grate	0.0	0.00	3.13	2.73	1.63	2.00	0.030	0.030	0.000	-0.01	-0.36	0.16	1.37	2.0	Off	
28	CB29	0.23	0.00	0.23	0.00	Grate	0.0	0.00	3.13	2.73	1.63	2.00	0.030	0.030	0.000	-0.11	-3.75	0.05	0.48	2.0	Off	
29	CB30	0.16	0.00	0.16	0.00	Grate	0.0	0.00	3.13	2.73	1.63	2.00	0.030	0.030	0.000	-0.12	-4.12	0.04	0.38	2.0	Off	
30	CB31	0.89	0.00	0.89	0.00	Grate	0.0	0.00	3.13	2.73	1.63	2.00	0.030	0.030	0.000	-0.03	-1.08	0.13	1.18	2.0	Off	

Project File: 2021-12-17 Model.stm

Number of lines: 30

Run Date: 12-17-2021

NOTES: Inlet N-Values = 0.016 ; Intensity = 43.38 / (inlet time + 3.80) ^ 0.72; Return period = 25 Yrs. ; \* Indicates Known Q added. All curb inlets are Horiz throat.

**SUPPLEMENTAL CULVERT & FLOODPLAIN ANALYSIS**  
**CASTERBRIDGE CROSSING**

**Re-Subdivision and Inland Wetland Applications**

**Dorset Crossing PAD**  
**Simsbury, Connecticut**

**March 24, 2017**

Prepared For:

**Dorset Crossing, LLC**  
**Applicant**

Prepared By:

**F. A. Hesketh & Associates, Inc.**  
**6 Creamery Brook**  
**East Granby, CT 06026**



**F. A. Hesketh**  
**& Associates, Inc.**

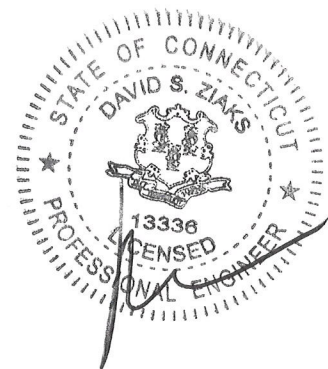

FAHA Project No.: 04174

# **SUPPLEMENTAL CULVERT & FLOODPLAIN ANALYSIS** **CASTERBRIDGE CROSSING**

## 1.0 INTRODUCTION

This report presents a summary of the supplemental hydraulic analysis completed for the proposed concrete box culvert crossing in the vicinity of Station 26+50 associated with the extension of Casterbridge Crossing. Casterbridge Crossing is a town road that currently terminates with a temporary cul-de-sac located approximately 200 feet south of the proposed culvert crossing. Also included in this report is an analysis of the impact of the proposed construction to the FEMA floodplain associated with Saxon Brook.

Casterbridge Crossing was previously constructed by the applicant to meet town standards up to the vicinity of Station 25+00+/- . From this point to the current temporary cul-de-sac, a temporary 24 foot +/- wide paved roadway was constructed with the expectation the road would be upgraded fully to town standards in a future phase of development involving Lots 13 A-D and/or 13 A-G. The crossing of Saxon Brook prior to the development of Dorset Crossing was completed years ago with the installation of temporary pipe culverts and a gravel roadway when the gravel removal operations were still active on the property.

The applicant is proposing to reconstruct the temporary portion of Casterbridge Crossing to current town standards including the installation of a new culvert for Saxon Brook, all underground public utilities and the new cul-de-sac. It is envisioned that this cul-de-sac would be removed in the future should Casterbridge Crossing be extended to the southerly abutting properties.

## 2.0 HYDROLOGIC ANALYSIS

A Preliminary Culvert Analysis was completed for the proposed crossing (copy attached) back in 2012 as part of the ongoing town approval process associated with the various phases of Dorset Crossing. Based on that analysis, a 5'X4' box culvert was selected for the Saxon Brook crossing.

During review of the current Inland Wetland application submitted, review comments from the Commission and town staff requested that the applicant explore opportunities to add a natural bottom surface to the culvert design and recalculate the hydraulic design analysis using the updated the TR-55 model based on current NOAA intensity data. The results of the new calculations are summarized in Table 1 attached. There is little change in the results for the 100-year design storm as compared to the 2012 analysis.

### 3.0 FLOODPLAIN ANALYSIS

Based on the current FIRM for Saxton Brook (copy attached), there is a mapped 100-year floodplain associated with the watercourse extending upstream through and past the project limits of Dorset Crossing. Unfortunately, it is a Zone A mapping meaning there are no calculated elevations established for the floodplain limits. The limit of the detailed flood study occurs just east of the Saxton Brook culvert crossing at Route 10 and indicates a flood elevation of 153, which is the floodplain elevation associated with the nearby Farmington River.

The construction drawings prepared by FAHA in 2012 for the widening of Route 10 near the Saxton Brook culvert crossing indicate the inlet elevation for the culvert system carrying the brook under Route 10 is 171.0+/- . This indicates that the effects of backwater from the Farmington River floodplain have little impact on the existing culvert under Route 10. Further upstream at the proposed culvert crossing for Casterbridge Crossing, the outfall elevation of the new box culvert would be 227.40. This means the average slope of Saxton Brook between the two culverts is around 2.8%.

Since there is no defined floodplain elevation along the floodplain limits, the analysis for the new culvert was tested assuming a tail water of between 1 and 3 feet. The results indicate there would be no change to the projected 100-year headwater elevation at the new box culvert based on tail water effects.



With respect to potential loss of floodplain storage capacity as a result of the proposed construction, there will be a negligible change of net flood storage capacity since fill for the current crossing was placed many years ago and will be replaced with new gravel fill to support the improved roadway. It could be argued that there may be a slight increase created as a result of removing the two restrictive 24" diameter culverts which have a total cross sectional area of around 6.3 s.f. with the new box culvert which has a cross sectional area of 20 s.f.



# Untitled Map

Write a description for your map.

## Legend

-  Dorset Crossing Dr
-  Proposed Culvert Crossing



No.	Date	Description
1	08-19-2016	Plan Applications
2	08-19-2016	Plan Applications
3	11-29-2016	General
4	10-10-2017	Team comments
5	08-08-2017	Revised comments

Rev	Sheet no.	of
1	0174	1

DRAINAGE  
 CONTROL PLAN  
 30' W  
 CROSSING, LLC  
 CONNECTING

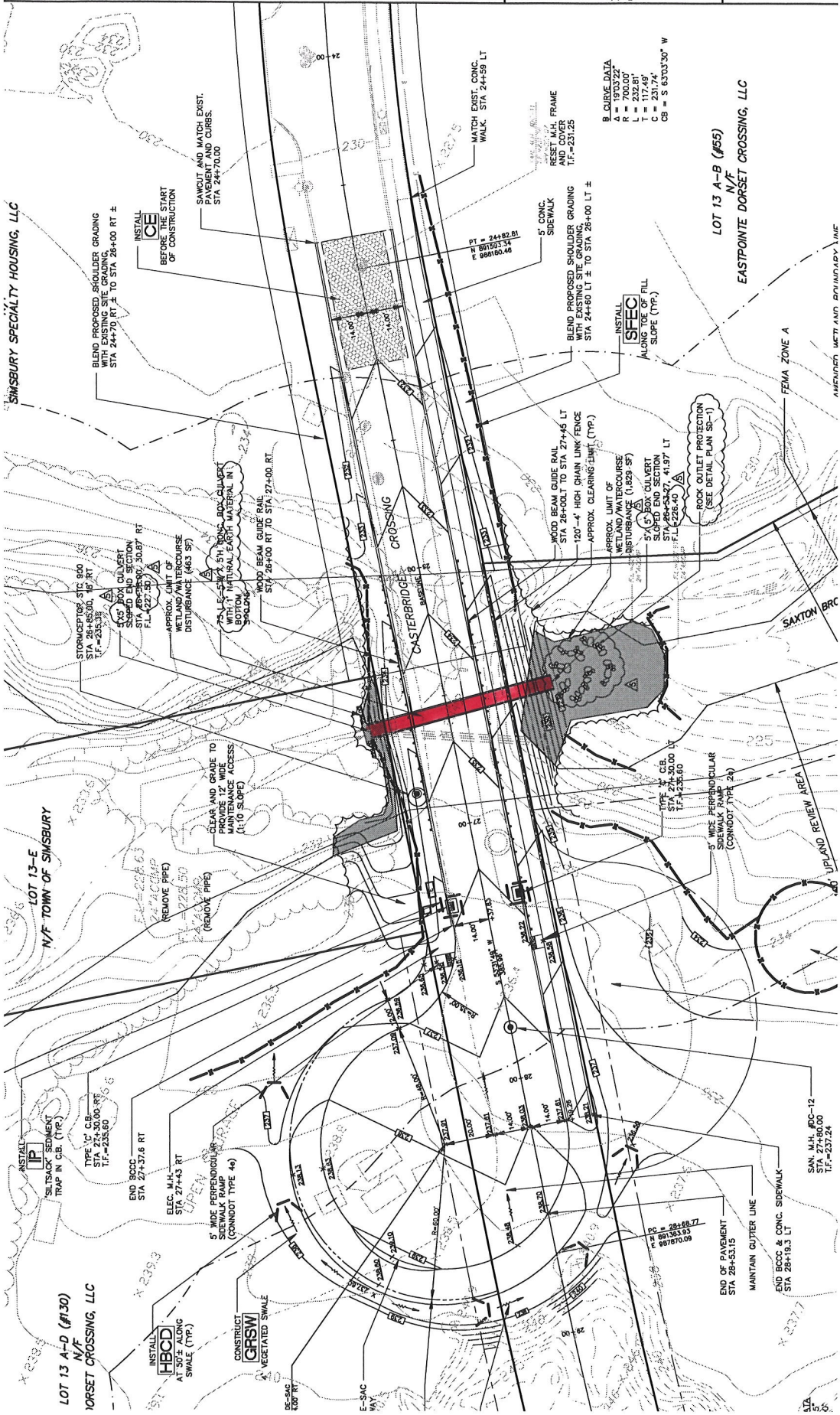

SWISSBURY SPECIALTY HOUSING, LLC  
 LOT 13-E N/F TOWN OF SWISSBURY  
 LOT 13 A-D (#130) N/F DORSET CROSSING, LLC  
 LOT 13 A-B (#55) N/F EASTPOINTE DORSET CROSSING, LLC  
 FEMA ZONE A  
 SAKTON BRG  
 UPLAND REVIEW AREA  
 SAN. M.H. #00-12 STA 28+51.00 T.F. = 237.24  
 END OF PAVEMENT STA 28+51.15 MAINTAIN CUTTER LINE  
 END HBCC & CONC. SIDEWALK STA 28+18.3 LT  
 5' CONC. SIDEWALK STA 24+80 LT ± TO STA 28+00 LT ±  
 BLEND PROPOSED SHOULDER GRADING WITH EXISTING SITE GRADING.  
 STA 24+80 LT ± TO STA 28+00 LT ±  
 B. CURVE DATA  
 A = 19'03'22"  
 R = 700.00'  
 T = 117.49'  
 C = 231.74'  
 CB = S 63'03'30" W  
 RESEAL W.H. FRAME STA 24+21.25 T.F. = 231.25  
 MATCH EXIST. CONC. WALK. STA 24+59 LT  
 SAWCUT AND MATCH EXIST. SIDEWALK AND CURBS. STA 24+70.00  
 INSTALL CE BEFORE THE START OF CONSTRUCTION  
 BLEND PROPOSED SHOULDER GRADING WITH EXISTING SITE GRADING. STA 44+70 RT ± TO STA 26+00 RT ±  
 STORAGE TOP, STC 800 STA 26+48.00, 15 RT T.F. = 235.50  
 4" DIA. CULVERT SLOPED END SECTION STA 26+26.90, 30.87 RT P.L. = 227.50  
 APPROX. LIMIT OF WETLAND/WATERCOURSE DISTURBANCE (463 SF)  
 5" DIA. CULVERT SLOPED END SECTION STA 26+26.90, 30.87 RT P.L. = 227.50  
 WITH 1" NATURAL EARTH MATERIAL IN BOTTOM. 3' WIDE PERPENDICULAR SWALE (CONDUIT TYPE 4)  
 CLEAR AND GRADE TO PROVIDE DRAINAGE ADDRESS (1:10 SLOPE)  
 WOOD BEAM GUIDE RAIL STA 27+00 RT TO STA 27+40 RT  
 WOOD BEAM GUIDE RAIL STA 27+45 LT TO STA 27+45 LT  
 120'-4" HIGH CHAIN LINK FENCE APPROX. CLEARING LIMIT (TYP.)  
 APPROX. LIMIT OF WETLAND/WATERCOURSE DISTURBANCE (1,829 SF)  
 5" DIA. CULVERT SLOPED END SECTION STA 28+53.27, 41.97 LT T.F. = 226.40  
 ROCK OUTLET PROTECTION (SEE DETAIL PLAN 80-1)  
 5" WIDE PERPENDICULAR SWALE (CONDUIT TYPE 24)  
 STA 28+00 TO STA 28+51.15 T.F. = 237.80  
 END OF PAVEMENT STA 28+51.15 MAINTAIN CUTTER LINE  
 END HBCC & CONC. SIDEWALK STA 28+18.3 LT  
 SAN. M.H. #00-12 STA 28+51.00 T.F. = 237.24

## SUMMARY TABLE 1

CULVERT ANALYSIS  
PROPOSED CONDITIONS-100 YEAR STORM

DORSET CROSSING, SIMSBURY, CT

PLANS DATED 02/27/2017

CULVERT AT	CULVERT CHARACTERISTIC		DETENTION POND			CULVERT MANNING COEFFICIENT	CULVERT BOTTOM CONDITIONS
	SIZE (INCHES)	MATERIAL	FLOW IN (CFS)	FLOW OUT (CFS)	ELEVATION (FEET)		
1	2	3	4	5	6	7	8
1 FT Tailwater	60"x48" *	CONCRETE	126.3	126.6	232.83	0.02	Gravel/Random Stone
2 FT Tailwater	60"x48"	CONCRETE	126.3	126.6	232.83	0.02	Gravel/Random Stone
3 FT Tailwater	60"x48"	CONCRETE	126.3	126.6	232.83	0.02	Gravel/Random Stone

\* (CULVERT DESIGN DIMENTIONS)



# Hydraflow IDF Curves

IDF file: NOAA ATLAS 14, VOL10, V2.IDF

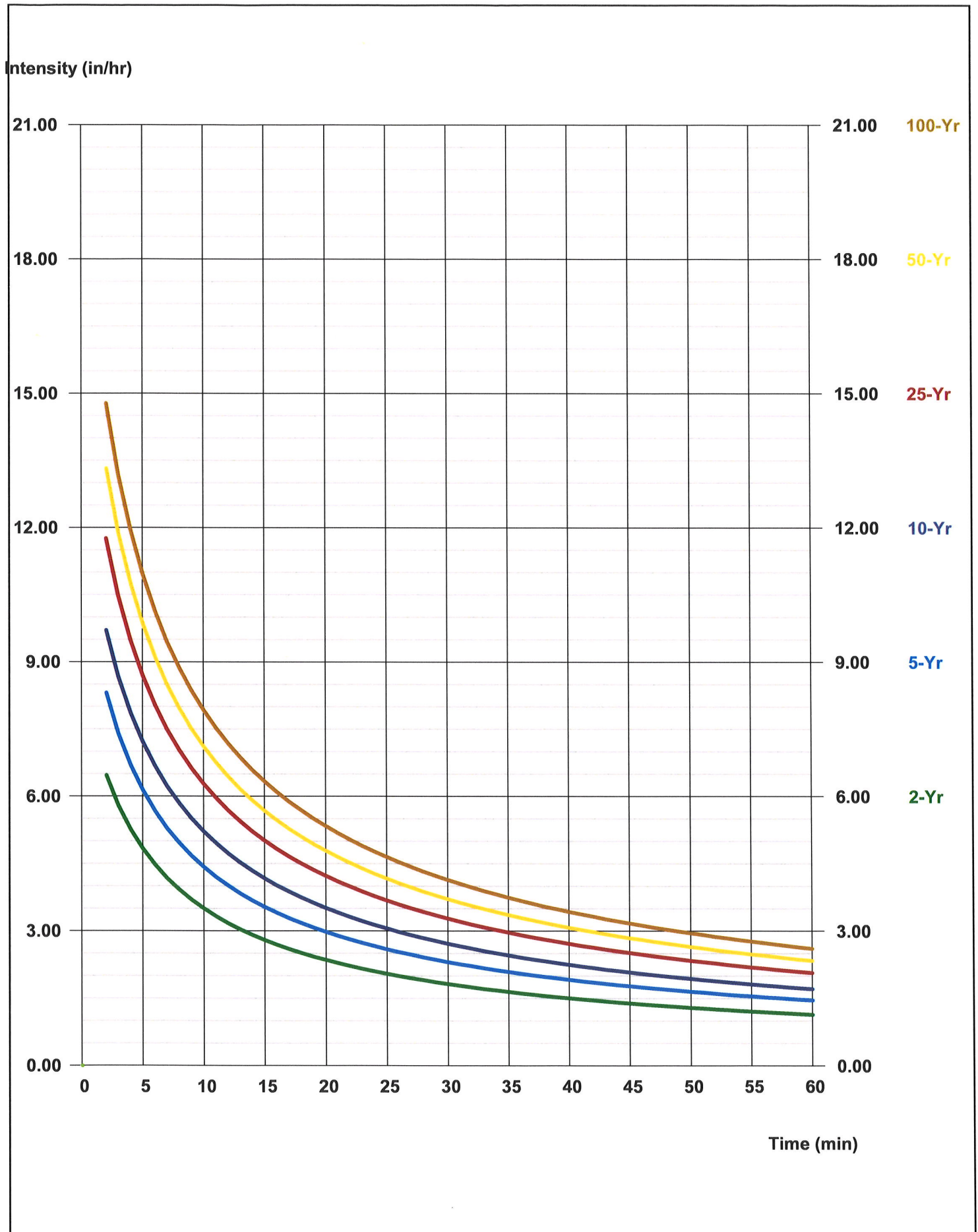

# Hydraflow Table of Contents

<b>Watershed Model Schematic .....</b>	<b>1</b>
<b>Hydrograph Return Period Recap .....</b>	<b>2</b>
<b>100 - Year</b>	
<b>Summary Report .....</b>	<b>3</b>
<b>Hydrograph Reports .....</b>	<b>4</b>
Hydrograph No. 1, SCS Runoff, Watershed Culvert .....	4
Hydrograph No. 2, Reservoir, Culvert .....	5
Pond Report - Culvert .....	6

# Watershed Model Schematic

Hydraflow Hydrographs by Intelisolve v9.1

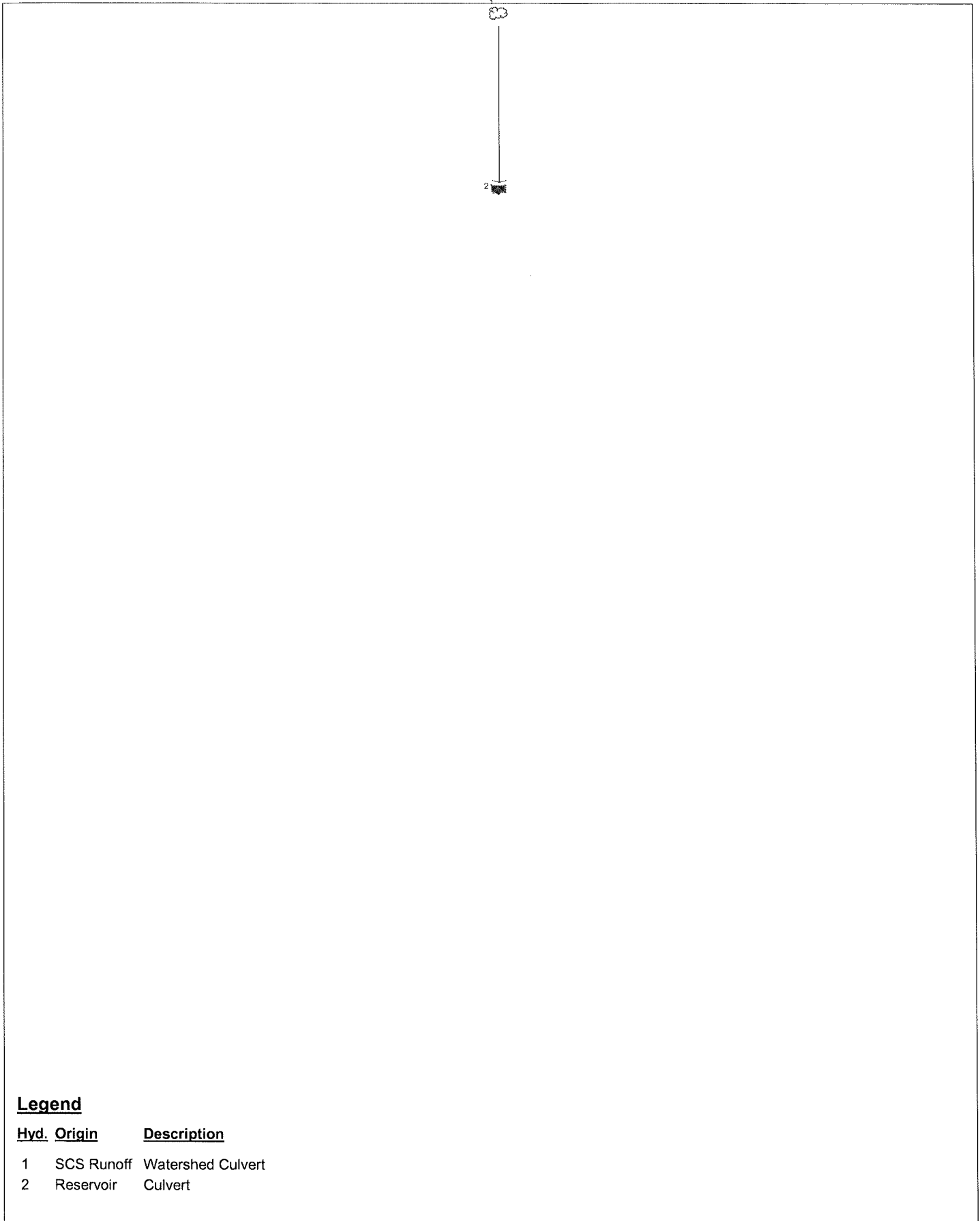

### Legend

<u>Hyd. Origin</u>	<u>Description</u>
1	SCS Runoff Watershed Culvert
2	Reservoir Culvert

# Hydrograph Return Period Recap

Hydraflow Hydrographs by Intelisolve v9.1

Hyd. No.	Hydrograph type (origin)	Inflow Hyd(s)	Peak Outflow (cfs)								Hydrograph description
			1-Yr	2-Yr	3-Yr	5-Yr	10-Yr	25-Yr	50-Yr	100-Yr	
1	SCS Runoff	-----	-----	13.88	-----	-----	50.68	76.21	100.57	126.33	Watershed Culvert
2	Reservoir	1	-----	13.89	-----	-----	50.77	75.97	100.20	126.62	Culvert



# Hydrograph Summary Report

Hydraflow Hydrographs by Intelisolve v9.1

Hyd. No.	Hydrograph type (origin)	Peak flow (cfs)	Time interval (min)	Time to peak (min)	Hyd. volume (cuft)	Inflow hyd(s)	Maximum elevation (ft)	Total strge used (cuft)	Hydrograph description
1	SCS Runoff	126.33	6	762	993,060	----	-----	-----	Watershed Culvert
2	Reservoir	126.62	6	762	993,060	1	232.83	12,113	Culvert
04174p-culvert-1.gpw					Return Period: 100 Year		Monday, Feb 27, 2017		

# Hydrograph Report

Hydraflow Hydrographs by Intelisolve v9.1

Monday, Feb 27, 2017

## Hyd. No. 1

### Watershed Culvert

Hydrograph type = SCS Runoff  
Storm frequency = 100 yrs  
Time interval = 6 min  
Drainage area = 108.000 ac  
Basin Slope = 0.0 %  
Tc method = USER  
Total precip. = 6.90 in  
Storm duration = 24 hrs

Peak discharge = 126.33 cfs  
Time to peak = 12.70 hrs  
Hyd. volume = 993,060 cuft  
Curve number = 60  
Hydraulic length = 0 ft  
Time of conc. (Tc) = 53.00 min  
Distribution = Type III  
Shape factor = 484

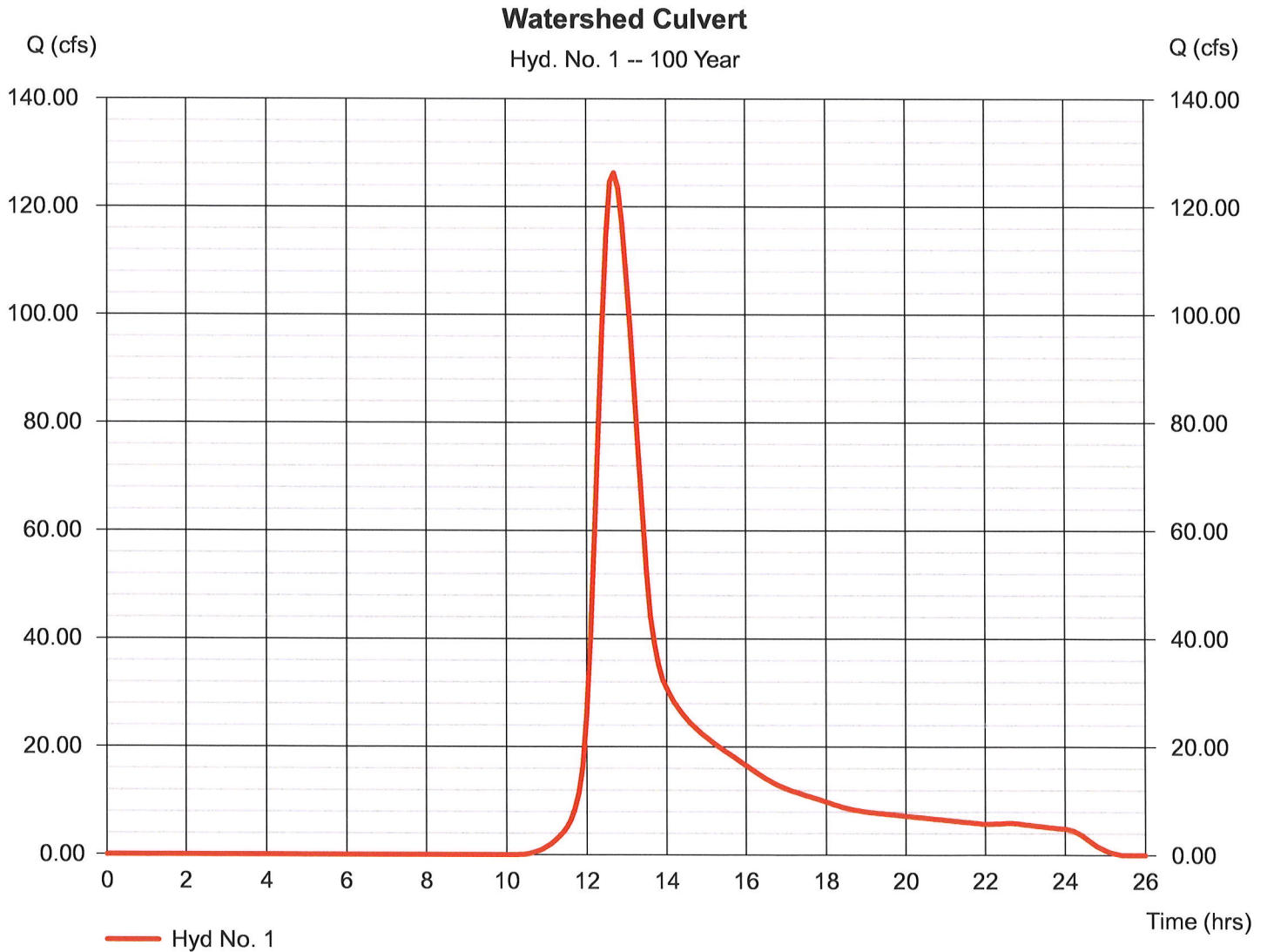

# Hydrograph Report

Hydraflow Hydrographs by Intelisolve v9.1

Monday, Feb 27, 2017

## Hyd. No. 2

### Culvert

Hydrograph type = Reservoir  
Storm frequency = 100 yrs  
Time interval = 6 min  
Inflow hyd. No. = 1 - Watershed Culvert  
Reservoir name = Culvert

Peak discharge = 126.62 cfs  
Time to peak = 12.70 hrs  
Hyd. volume = 993,060 cuft  
Max. Elevation = 232.83 ft  
Max. Storage = 12,113 cuft

Storage Indication method used.

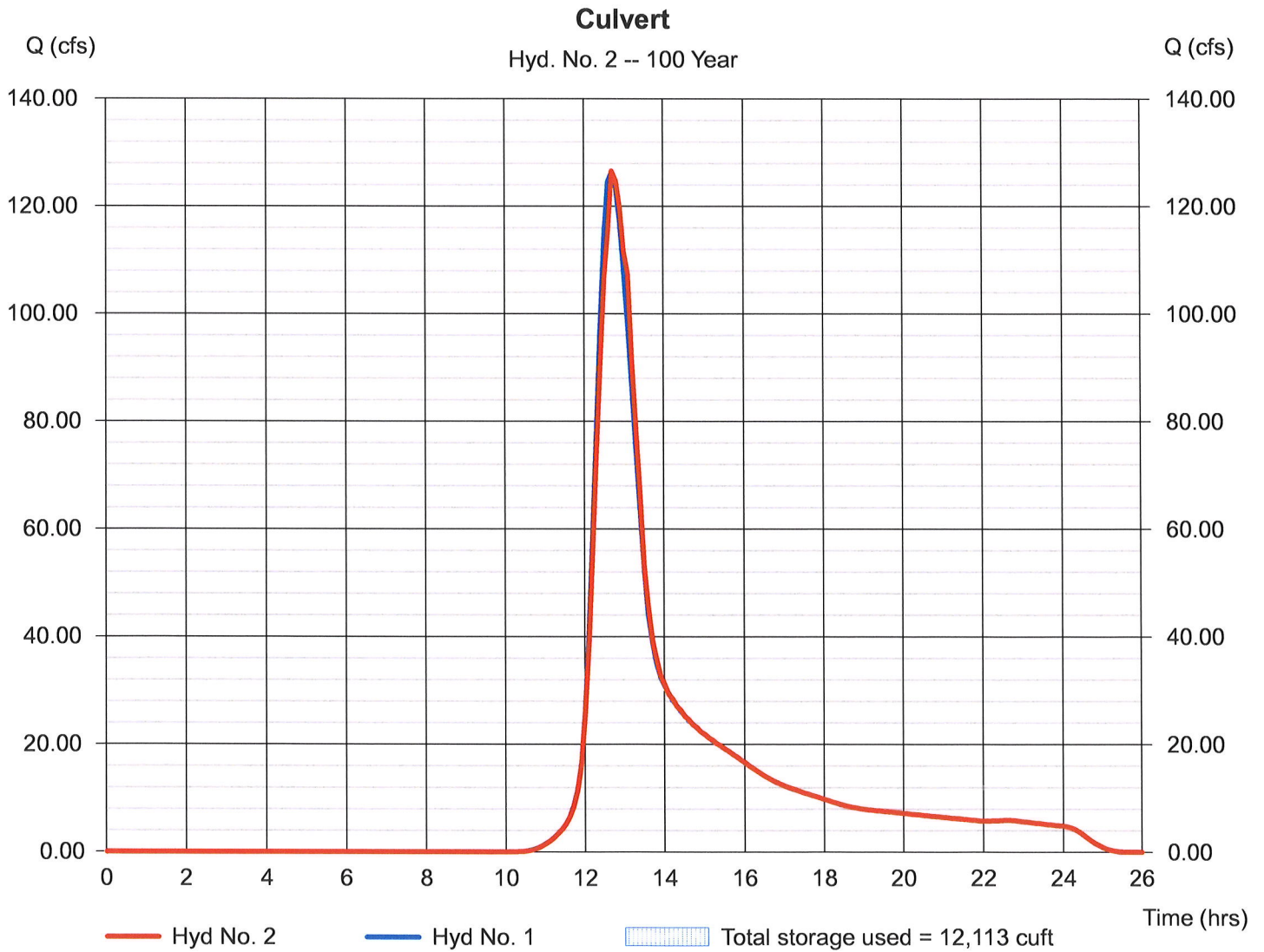

# Pond Report

Hydraflow Hydrographs by Intelisolve v9.1

Monday, Feb 27, 2017

## Pond No. 1 - Culvert

### Pond Data

Contours - User-defined contour areas. Conic method used for volume calculation. Beginning Elevation = 228.50 ft

### Stage / Storage Table

Stage (ft)	Elevation (ft)	Contour area (sqft)	Incr. Storage (cuft)	Total storage (cuft)
0.00	228.50	00	0	0
1.50	230.00	828	414	414
2.50	231.00	2,951	1,781	2,194
3.50	232.00	5,572	4,192	6,387
4.50	233.00	8,442	6,957	13,344
5.50	234.00	33,270	19,488	32,832
6.50	235.00	68,366	49,771	82,603

### Culvert / Orifice Structures

	[A]	[B]	[C]	[PrfRsr]
Rise (in)	= 48.00	0.00	0.00	0.00
Span (in)	= 60.00	0.00	0.00	0.00
No. Barrels	= 1	1	0	0
Invert El. (ft)	= 228.50	0.00	0.00	0.00
Length (ft)	= 70.00	0.00	0.00	0.00
Slope (%)	= 1.50	0.00	0.00	n/a
N-Value	= .020	.012	.013	n/a
Orifice Coeff.	= 0.60	0.60	0.60	0.60
Multi-Stage	= n/a	No	No	No

### Weir Structures

	[A]	[B]	[C]	[D]
Crest Len (ft)	= 0.00	0.00	0.00	0.00
Crest El. (ft)	= 0.00	0.00	0.00	0.00
Weir Coeff.	= 2.60	3.33	3.33	3.33
Weir Type	= Broad	---	---	---
Multi-Stage	= No	No	No	No
Exfil.(in/hr)	= 0.000 (by Contour)			
TW Elev. (ft)	= 228.62			

Note: Culvert/Orifice outflows are analyzed under inlet (ic) and outlet (oc) control. Weir risers checked for orifice conditions (ic) and submergence (s).

### Stage / Storage / Discharge Table

Stage ft	Storage cuft	Elevation ft	Civ A cfs	Civ B cfs	Civ C cfs	PrfRsr cfs	Wr A cfs	Wr B cfs	Wr C cfs	Wr D cfs	Exfil cfs	User cfs	Total cfs
0.00	0	228.50	0.00	---	---	---	---	---	---	---	---	---	0.00
0.15	41	228.65	0.30 oc	---	---	---	---	---	---	---	---	---	0.30
0.30	83	228.80	2.05 oc	---	---	---	---	---	---	---	---	---	2.05
0.45	124	228.95	4.93 oc	---	---	---	---	---	---	---	---	---	4.93
0.60	166	229.10	7.91 ic	---	---	---	---	---	---	---	---	---	7.91
0.75	207	229.25	11.06 ic	---	---	---	---	---	---	---	---	---	11.06
0.90	248	229.40	14.53 ic	---	---	---	---	---	---	---	---	---	14.53
1.05	290	229.55	18.31 ic	---	---	---	---	---	---	---	---	---	18.31
1.20	331	229.70	22.38 ic	---	---	---	---	---	---	---	---	---	22.38
1.35	373	229.85	26.70 ic	---	---	---	---	---	---	---	---	---	26.70
1.50	414	230.00	31.27 ic	---	---	---	---	---	---	---	---	---	31.27
1.60	592	230.10	34.45 ic	---	---	---	---	---	---	---	---	---	34.45
1.70	770	230.20	37.73 ic	---	---	---	---	---	---	---	---	---	37.73
1.80	948	230.30	41.11 ic	---	---	---	---	---	---	---	---	---	41.11
1.90	1,126	230.40	44.58 ic	---	---	---	---	---	---	---	---	---	44.58
2.00	1,304	230.50	48.15 ic	---	---	---	---	---	---	---	---	---	48.15
2.10	1,482	230.60	51.81 ic	---	---	---	---	---	---	---	---	---	51.81
2.20	1,660	230.70	55.55 ic	---	---	---	---	---	---	---	---	---	55.55
2.30	1,838	230.80	59.38 ic	---	---	---	---	---	---	---	---	---	59.38
2.40	2,016	230.90	63.30 ic	---	---	---	---	---	---	---	---	---	63.30
2.50	2,194	231.00	67.29 ic	---	---	---	---	---	---	---	---	---	67.29
2.60	2,614	231.10	71.37 ic	---	---	---	---	---	---	---	---	---	71.37
2.70	3,033	231.20	75.53 ic	---	---	---	---	---	---	---	---	---	75.53
2.80	3,452	231.30	79.76 ic	---	---	---	---	---	---	---	---	---	79.76
2.90	3,871	231.40	83.30 oc	---	---	---	---	---	---	---	---	---	83.30
3.00	4,291	231.50	86.41 oc	---	---	---	---	---	---	---	---	---	86.41
3.10	4,710	231.60	89.52 oc	---	---	---	---	---	---	---	---	---	89.52
3.20	5,129	231.70	92.64 oc	---	---	---	---	---	---	---	---	---	92.64
3.30	5,548	231.80	95.75 oc	---	---	---	---	---	---	---	---	---	95.75
3.40	5,968	231.90	98.86 oc	---	---	---	---	---	---	---	---	---	98.86
3.50	6,387	232.00	101.97 oc	---	---	---	---	---	---	---	---	---	101.97
3.60	7,082	232.10	105.08 oc	---	---	---	---	---	---	---	---	---	105.08
3.70	7,778	232.20	108.20 oc	---	---	---	---	---	---	---	---	---	108.20
3.80	8,474	232.30	111.31 oc	---	---	---	---	---	---	---	---	---	111.31
3.90	9,169	232.40	114.42 oc	---	---	---	---	---	---	---	---	---	114.42

Continues on next page...

Culvert

**Stage / Storage / Discharge Table**

Stage ft	Storage cuft	Elevation ft	Clv A cfs	Clv B cfs	Clv C cfs	PrfRsr cfs	Wr A cfs	Wr B cfs	Wr C cfs	Wr D cfs	Exfil cfs	User cfs	Total cfs
4.00	9,865	232.50	110.74 oc	---	---	---	---	---	---	---	---	---	110.74
4.10	10,561	232.60	115.89 oc	---	---	---	---	---	---	---	---	---	115.89
4.20	11,257	232.70	120.82 oc	---	---	---	---	---	---	---	---	---	120.82
4.30	11,952	232.80	125.56 oc	---	---	---	---	---	---	---	---	---	125.56
4.40	12,648	232.90	130.13 oc	---	---	---	---	---	---	---	---	---	130.13
4.50	13,344	233.00	134.54 oc	---	---	---	---	---	---	---	---	---	134.54
4.60	15,292	233.10	138.81 oc	---	---	---	---	---	---	---	---	---	138.81
4.70	17,241	233.20	142.96 oc	---	---	---	---	---	---	---	---	---	142.96
4.80	19,190	233.30	146.99 oc	---	---	---	---	---	---	---	---	---	146.99
4.90	21,139	233.40	150.91 oc	---	---	---	---	---	---	---	---	---	150.91
5.00	23,088	233.50	154.73 oc	---	---	---	---	---	---	---	---	---	154.73
5.10	25,037	233.60	158.46 oc	---	---	---	---	---	---	---	---	---	158.46
5.20	26,985	233.70	162.10 oc	---	---	---	---	---	---	---	---	---	162.10
5.30	28,934	233.80	165.66 oc	---	---	---	---	---	---	---	---	---	165.66
5.40	30,883	233.90	169.15 oc	---	---	---	---	---	---	---	---	---	169.15
5.50	32,832	234.00	172.57 oc	---	---	---	---	---	---	---	---	---	172.57
5.60	37,809	234.10	175.92 oc	---	---	---	---	---	---	---	---	---	175.92
5.70	42,786	234.20	179.21 oc	---	---	---	---	---	---	---	---	---	179.21
5.80	47,763	234.30	182.44 oc	---	---	---	---	---	---	---	---	---	182.44
5.90	52,740	234.40	185.61 oc	---	---	---	---	---	---	---	---	---	185.61
6.00	57,717	234.50	188.73 oc	---	---	---	---	---	---	---	---	---	188.73
6.10	62,695	234.60	191.80 oc	---	---	---	---	---	---	---	---	---	191.80
6.20	67,672	234.70	194.82 oc	---	---	---	---	---	---	---	---	---	194.82
6.30	72,649	234.80	197.79 oc	---	---	---	---	---	---	---	---	---	197.79
6.40	77,626	234.90	200.72 oc	---	---	---	---	---	---	---	---	---	200.72
6.50	82,603	235.00	203.61 oc	---	---	---	---	---	---	---	---	---	203.61

...End

# Hydraflow Table of Contents

<b>Watershed Model Schematic .....</b>	<b>1</b>
<b>Hydrograph Return Period Recap .....</b>	<b>2</b>
<b>100 - Year</b>	
<b>Summary Report .....</b>	<b>3</b>
<b>Hydrograph Reports .....</b>	<b>4</b>
Hydrograph No. 1, SCS Runoff, Watershed Culvert .....	4
Hydrograph No. 2, Reservoir, Culvert .....	5
Pond Report - Culvert .....	6

# Watershed Model Schematic

Hydraflow Hydrographs by Intelisolve v9.1

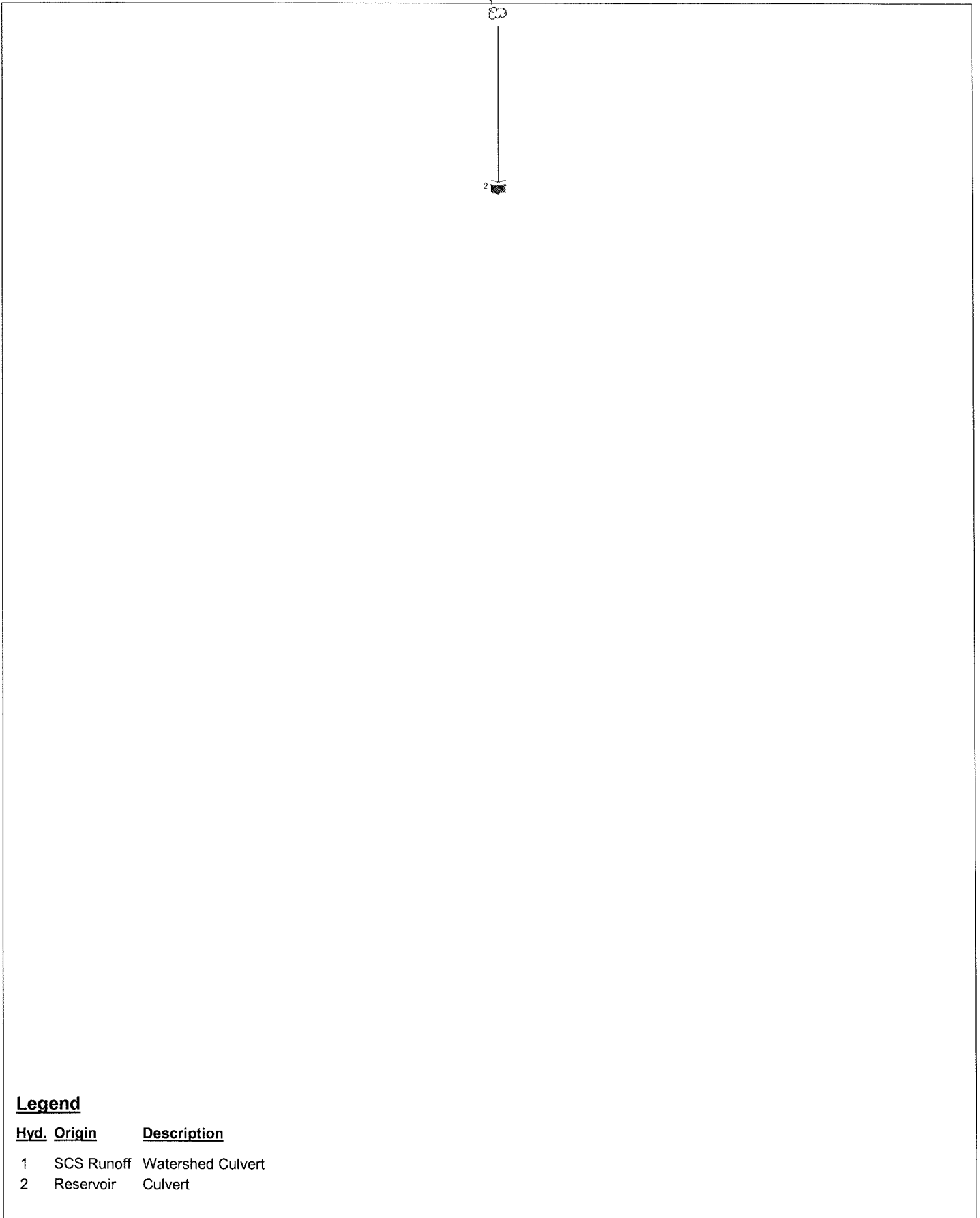

### Legend

<u>Hyd. Origin</u>	<u>Description</u>
1	SCS Runoff Watershed Culvert
2	Reservoir Culvert

# Hydrograph Return Period Recap

Hydraflow Hydrographs by Intelisolve v9.1

Hyd. No.	Hydrograph type (origin)	Inflow Hyd(s)	Peak Outflow (cfs)								Hydrograph description
			1-Yr	2-Yr	3-Yr	5-Yr	10-Yr	25-Yr	50-Yr	100-Yr	
1	SCS Runoff	-----	-----	13.88	-----	-----	50.68	76.21	100.57	126.33	Watershed Culvert
2	Reservoir	1	-----	14.40	-----	-----	50.60	76.01	100.20	126.62	Culvert



# Hydrograph Summary Report

Hydraflow Hydrographs by Intelisolve v9.1

Hyd. No.	Hydrograph type (origin)	Peak flow (cfs)	Time interval (min)	Time to peak (min)	Hyd. volume (cuft)	Inflow hyd(s)	Maximum elevation (ft)	Total strge used (cuft)	Hydrograph description
1	SCS Runoff	126.33	6	762	993,060	----	-----	-----	Watershed Culvert
2	Reservoir	126.62	6	762	992,770	1	232.83	12,113	Culvert
04174p-culvert-1.gpw					Return Period: 100 Year		Monday, Feb 27, 2017		

# Hydrograph Report

Hydraflow Hydrographs by Intelisolve v9.1

Monday, Feb 27, 2017

## Hyd. No. 1

### Watershed Culvert

Hydrograph type = SCS Runoff  
Storm frequency = 100 yrs  
Time interval = 6 min  
Drainage area = 108.000 ac  
Basin Slope = 0.0 %  
Tc method = USER  
Total precip. = 6.90 in  
Storm duration = 24 hrs

Peak discharge = 126.33 cfs  
Time to peak = 12.70 hrs  
Hyd. volume = 993,060 cuft  
Curve number = 60  
Hydraulic length = 0 ft  
Time of conc. (Tc) = 53.00 min  
Distribution = Type III  
Shape factor = 484

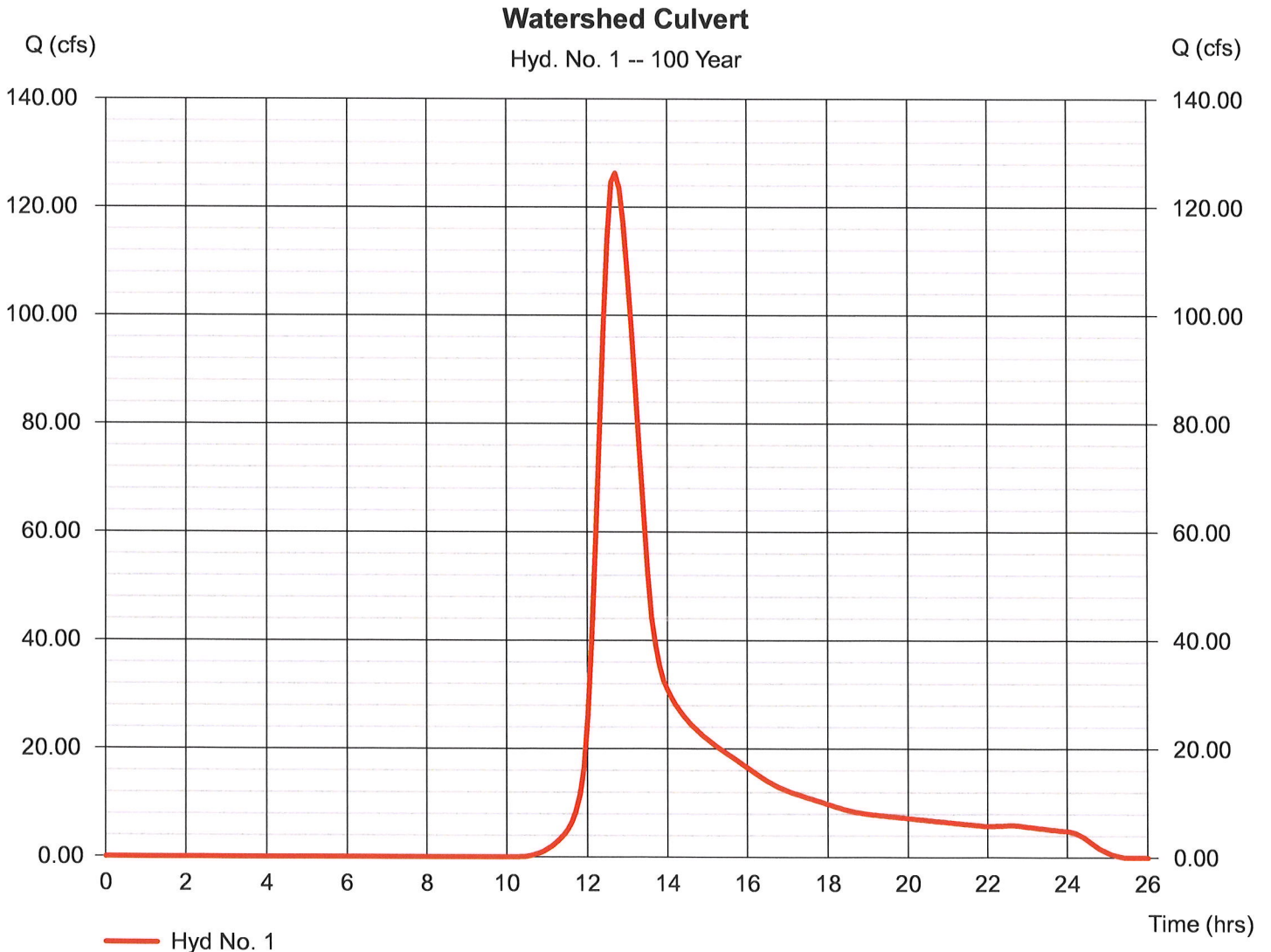

# Hydrograph Report

Hydraflow Hydrographs by Intelisolve v9.1

Monday, Feb 27, 2017

## Hyd. No. 2

### Culvert

Hydrograph type = Reservoir  
Storm frequency = 100 yrs  
Time interval = 6 min  
Inflow hyd. No. = 1 - Watershed Culvert  
Reservoir name = Culvert

Peak discharge = 126.62 cfs  
Time to peak = 12.70 hrs  
Hyd. volume = 992,770 cuft  
Max. Elevation = 232.83 ft  
Max. Storage = 12,113 cuft

Storage Indication method used.

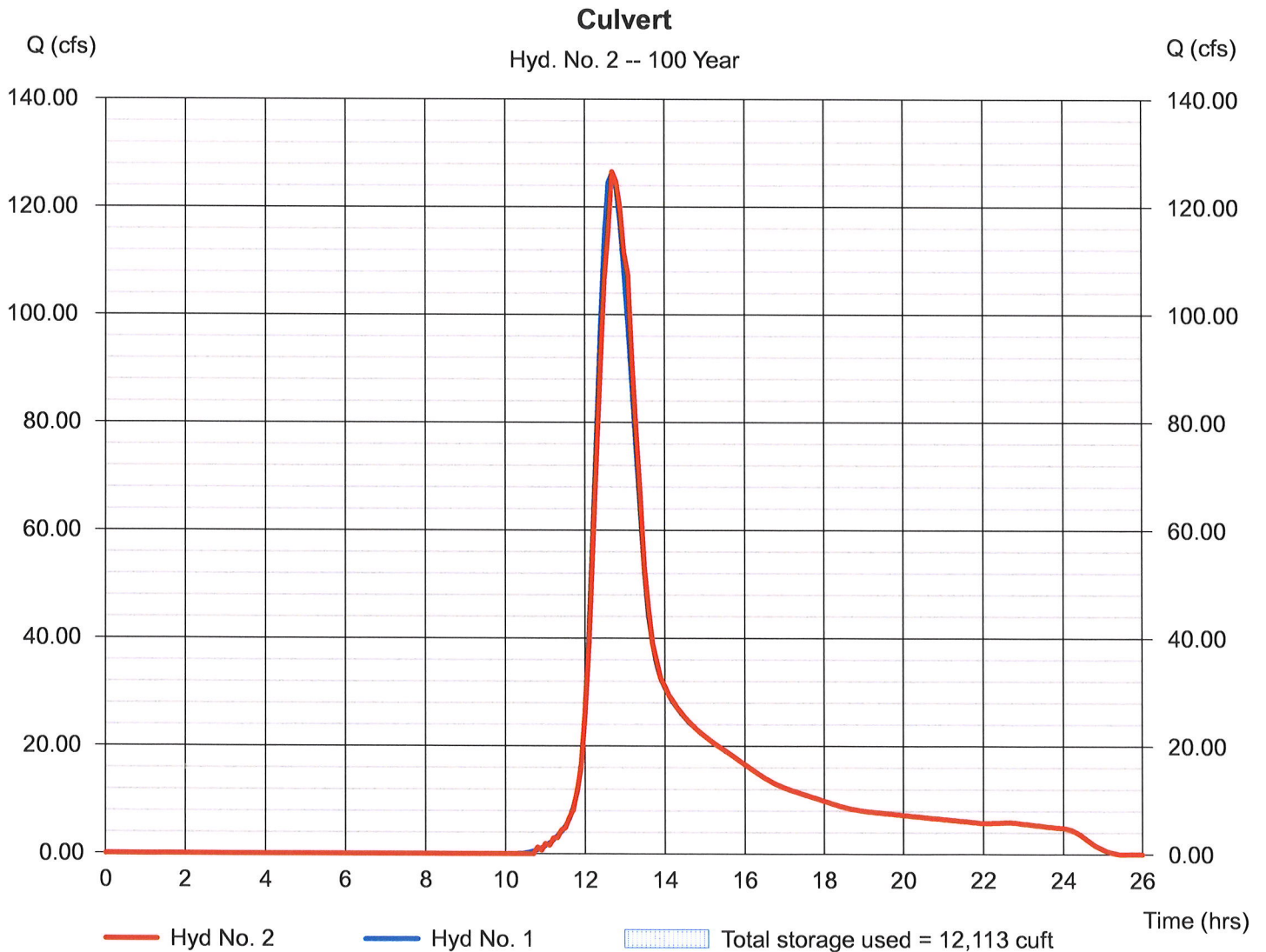

# Pond Report

## Pond No. 1 - Culvert

### Pond Data

Contours - User-defined contour areas. Conic method used for volume calculation. Beginning Elevation = 228.50 ft

### Stage / Storage Table

Stage (ft)	Elevation (ft)	Contour area (sqft)	Incr. Storage (cuft)	Total storage (cuft)
0.00	228.50	00	0	0
1.50	230.00	828	414	414
2.50	231.00	2,951	1,781	2,194
3.50	232.00	5,572	4,192	6,387
4.50	233.00	8,442	6,957	13,344
5.50	234.00	33,270	19,488	32,832
6.50	235.00	68,366	49,771	82,603

### Culvert / Orifice Structures

	[A]	[B]	[C]	[PrfRsr]
Rise (in)	= 48.00	0.00	0.00	0.00
Span (in)	= 60.00	0.00	0.00	0.00
No. Barrels	= 1	1	0	0
Invert El. (ft)	= 228.50	0.00	0.00	0.00
Length (ft)	= 70.00	0.00	0.00	0.00
Slope (%)	= 1.50	0.00	0.00	n/a
N-Value	= .020	.012	.013	n/a
Orifice Coeff.	= 0.60	0.60	0.60	0.60
Multi-Stage	= n/a	No	No	No

### Weir Structures

	[A]	[B]	[C]	[D]
Crest Len (ft)	= 0.00	0.00	0.00	0.00
Crest El. (ft)	= 0.00	0.00	0.00	0.00
Weir Coeff.	= 2.60	3.33	3.33	3.33
Weir Type	= Broad	---	---	---
Multi-Stage	= No	No	No	No
Exfil.(in/hr)	= 0.000 (by Contour)			
TW Elev. (ft)	= 229.62			

Note: Culvert/Orifice outflows are analyzed under inlet (ic) and outlet (oc) control. Weir risers checked for orifice conditions (ic) and submergence (s).

### Stage / Storage / Discharge Table

Stage ft	Storage cuft	Elevation ft	Clv A cfs	Clv B cfs	Clv C cfs	PrfRsr cfs	Wr A cfs	Wr B cfs	Wr C cfs	Wr D cfs	Exfil cfs	User cfs	Total cfs
0.00	0	228.50	0.00	---	---	---	---	---	---	---	---	---	0.00
0.15	41	228.65	0.00	---	---	---	---	---	---	---	---	---	0.00
0.30	83	228.80	0.00	---	---	---	---	---	---	---	---	---	0.00
0.45	124	228.95	0.00	---	---	---	---	---	---	---	---	---	0.00
0.60	166	229.10	0.00	---	---	---	---	---	---	---	---	---	0.00
0.75	207	229.25	0.00	---	---	---	---	---	---	---	---	---	0.00
0.90	248	229.40	0.00	---	---	---	---	---	---	---	---	---	0.00
1.05	290	229.55	0.00	---	---	---	---	---	---	---	---	---	0.00
1.20	331	229.70	8.49 oc	---	---	---	---	---	---	---	---	---	8.49
1.35	373	229.85	16.54 oc	---	---	---	---	---	---	---	---	---	16.54
1.50	414	230.00	24.03 oc	---	---	---	---	---	---	---	---	---	24.03
1.60	592	230.10	29.08 oc	---	---	---	---	---	---	---	---	---	29.08
1.70	770	230.20	34.26 oc	---	---	---	---	---	---	---	---	---	34.26
1.80	948	230.30	39.58 oc	---	---	---	---	---	---	---	---	---	39.58
1.90	1,126	230.40	44.58 ic	---	---	---	---	---	---	---	---	---	44.58
2.00	1,304	230.50	48.15 ic	---	---	---	---	---	---	---	---	---	48.15
2.10	1,482	230.60	51.81 ic	---	---	---	---	---	---	---	---	---	51.81
2.20	1,660	230.70	55.55 ic	---	---	---	---	---	---	---	---	---	55.55
2.30	1,838	230.80	59.38 ic	---	---	---	---	---	---	---	---	---	59.38
2.40	2,016	230.90	63.30 ic	---	---	---	---	---	---	---	---	---	63.30
2.50	2,194	231.00	67.29 ic	---	---	---	---	---	---	---	---	---	67.29
2.60	2,614	231.10	71.37 ic	---	---	---	---	---	---	---	---	---	71.37
2.70	3,033	231.20	75.53 ic	---	---	---	---	---	---	---	---	---	75.53
2.80	3,452	231.30	79.76 ic	---	---	---	---	---	---	---	---	---	79.76
2.90	3,871	231.40	83.30 oc	---	---	---	---	---	---	---	---	---	83.30
3.00	4,291	231.50	86.41 oc	---	---	---	---	---	---	---	---	---	86.41
3.10	4,710	231.60	89.52 oc	---	---	---	---	---	---	---	---	---	89.52
3.20	5,129	231.70	92.64 oc	---	---	---	---	---	---	---	---	---	92.64
3.30	5,548	231.80	95.75 oc	---	---	---	---	---	---	---	---	---	95.75
3.40	5,968	231.90	98.86 oc	---	---	---	---	---	---	---	---	---	98.86
3.50	6,387	232.00	101.97 oc	---	---	---	---	---	---	---	---	---	101.97
3.60	7,082	232.10	105.08 oc	---	---	---	---	---	---	---	---	---	105.08
3.70	7,778	232.20	108.20 oc	---	---	---	---	---	---	---	---	---	108.20
3.80	8,474	232.30	111.31 oc	---	---	---	---	---	---	---	---	---	111.31
3.90	9,169	232.40	114.42 oc	---	---	---	---	---	---	---	---	---	114.42

Continues on next page...

Culvert

**Stage / Storage / Discharge Table**

Stage ft	Storage cuft	Elevation ft	Clv A cfs	Clv B cfs	Clv C cfs	PrfRsr cfs	Wr A cfs	Wr B cfs	Wr C cfs	Wr D cfs	Exfil cfs	User cfs	Total cfs
4.00	9,865	232.50	110.74 oc	---	---	---	---	---	---	---	---	---	110.74
4.10	10,561	232.60	115.89 oc	---	---	---	---	---	---	---	---	---	115.89
4.20	11,257	232.70	120.82 oc	---	---	---	---	---	---	---	---	---	120.82
4.30	11,952	232.80	125.56 oc	---	---	---	---	---	---	---	---	---	125.56
4.40	12,648	232.90	130.13 oc	---	---	---	---	---	---	---	---	---	130.13
4.50	13,344	233.00	134.54 oc	---	---	---	---	---	---	---	---	---	134.54
4.60	15,292	233.10	138.81 oc	---	---	---	---	---	---	---	---	---	138.81
4.70	17,241	233.20	142.96 oc	---	---	---	---	---	---	---	---	---	142.96
4.80	19,190	233.30	146.99 oc	---	---	---	---	---	---	---	---	---	146.99
4.90	21,139	233.40	150.91 oc	---	---	---	---	---	---	---	---	---	150.91
5.00	23,088	233.50	154.73 oc	---	---	---	---	---	---	---	---	---	154.73
5.10	25,037	233.60	158.46 oc	---	---	---	---	---	---	---	---	---	158.46
5.20	26,985	233.70	162.10 oc	---	---	---	---	---	---	---	---	---	162.10
5.30	28,934	233.80	165.66 oc	---	---	---	---	---	---	---	---	---	165.66
5.40	30,883	233.90	169.15 oc	---	---	---	---	---	---	---	---	---	169.15
5.50	32,832	234.00	172.57 oc	---	---	---	---	---	---	---	---	---	172.57
5.60	37,809	234.10	175.92 oc	---	---	---	---	---	---	---	---	---	175.92
5.70	42,786	234.20	179.21 oc	---	---	---	---	---	---	---	---	---	179.21
5.80	47,763	234.30	182.44 oc	---	---	---	---	---	---	---	---	---	182.44
5.90	52,740	234.40	185.61 oc	---	---	---	---	---	---	---	---	---	185.61
6.00	57,717	234.50	188.73 oc	---	---	---	---	---	---	---	---	---	188.73
6.10	62,695	234.60	191.80 oc	---	---	---	---	---	---	---	---	---	191.80
6.20	67,672	234.70	194.82 oc	---	---	---	---	---	---	---	---	---	194.82
6.30	72,649	234.80	197.79 oc	---	---	---	---	---	---	---	---	---	197.79
6.40	77,626	234.90	200.72 oc	---	---	---	---	---	---	---	---	---	200.72
6.50	82,603	235.00	203.61 oc	---	---	---	---	---	---	---	---	---	203.61

...End

# Hydraflow Table of Contents

<b>Watershed Model Schematic .....</b>	<b>1</b>
<b>Hydrograph Return Period Recap .....</b>	<b>2</b>
<b>100 - Year</b>	
<b>Summary Report .....</b>	<b>3</b>
<b>Hydrograph Reports .....</b>	<b>4</b>
Hydrograph No. 1, SCS Runoff, Watershed Culvert .....	4
Hydrograph No. 2, Reservoir, Culvert .....	5
Pond Report - Culvert .....	6

# Watershed Model Schematic

Hydraflow Hydrographs by Intelisolve v9.1

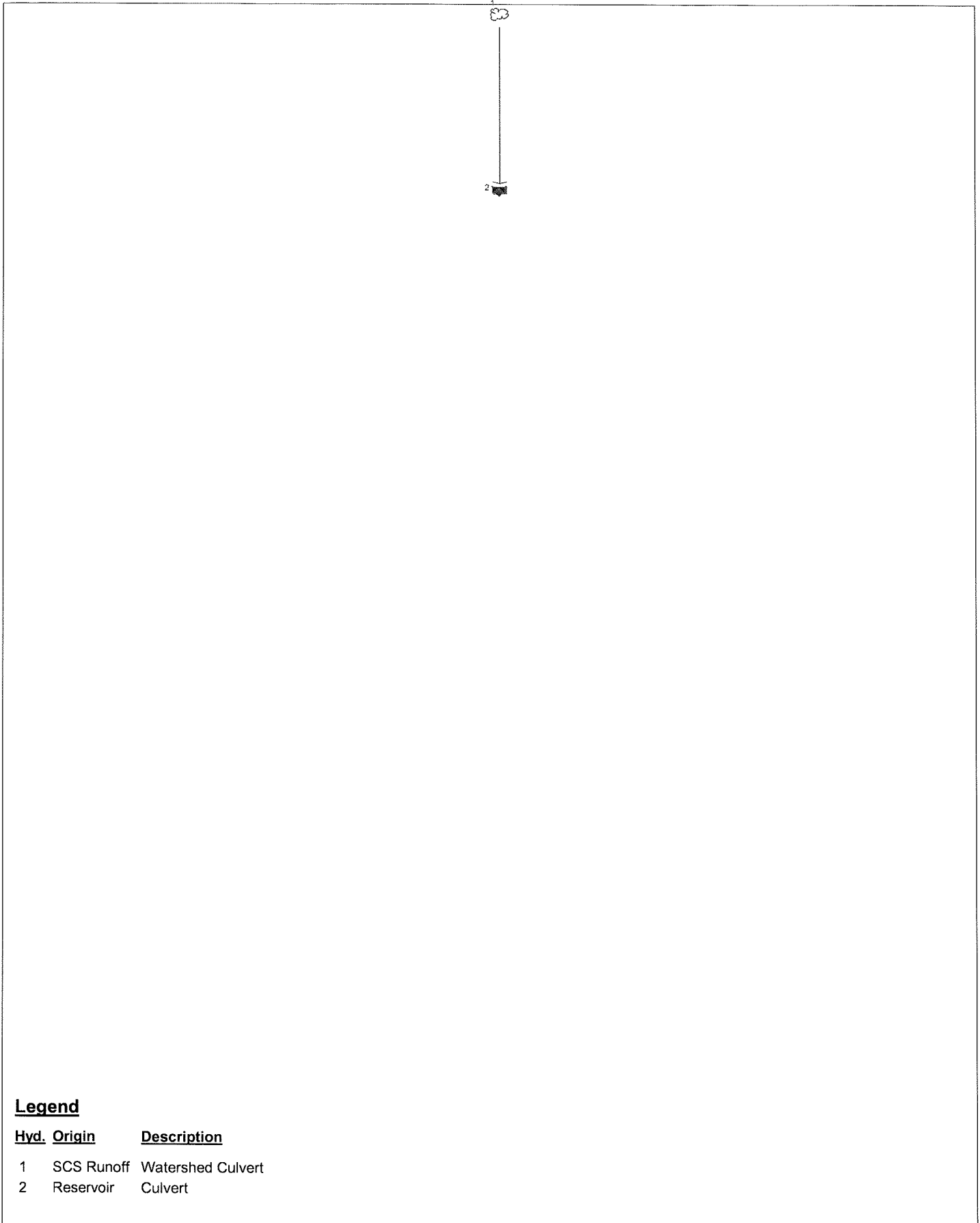

## Legend

<u>Hyd. Origin</u>	<u>Description</u>
1	SCS Runoff Watershed Culvert
2	Reservoir Culvert

# Hydrograph Return Period Recap

Hydraflow Hydrographs by Intelisolve v9.1

Hyd. No.	Hydrograph type (origin)	Inflow Hyd(s)	Peak Outflow (cfs)								Hydrograph description
			1-Yr	2-Yr	3-Yr	5-Yr	10-Yr	25-Yr	50-Yr	100-Yr	
1	SCS Runoff	-----	-----	13.88	-----	-----	50.68	76.21	100.57	126.33	Watershed Culvert
2	Reservoir	1	-----	13.97	-----	-----	50.74	76.20	100.09	126.63	Culvert



# Hydrograph Summary Report

Hydraflow Hydrographs by Intelisolve v9.1

Hyd. No.	Hydrograph type (origin)	Peak flow (cfs)	Time interval (min)	Time to peak (min)	Hyd. volume (cuft)	Inflow hyd(s)	Maximum elevation (ft)	Total strge used (cuft)	Hydrograph description
1	SCS Runoff	126.33	6	762	993,060	----	-----	-----	Watershed Culvert
2	Reservoir	126.63	6	762	991,578	1	232.83	12,114	Culvert
04174p-culvert-1.gpw					Return Period: 100 Year		Monday, Feb 27, 2017		

# Hydrograph Report

Hydraflow Hydrographs by Intelisolve v9.1

Monday, Feb 27, 2017

## Hyd. No. 1

### Watershed Culvert

Hydrograph type = SCS Runoff  
Storm frequency = 100 yrs  
Time interval = 6 min  
Drainage area = 108.000 ac  
Basin Slope = 0.0 %  
Tc method = USER  
Total precip. = 6.90 in  
Storm duration = 24 hrs

Peak discharge = 126.33 cfs  
Time to peak = 12.70 hrs  
Hyd. volume = 993,060 cuft  
Curve number = 60  
Hydraulic length = 0 ft  
Time of conc. (Tc) = 53.00 min  
Distribution = Type III  
Shape factor = 484

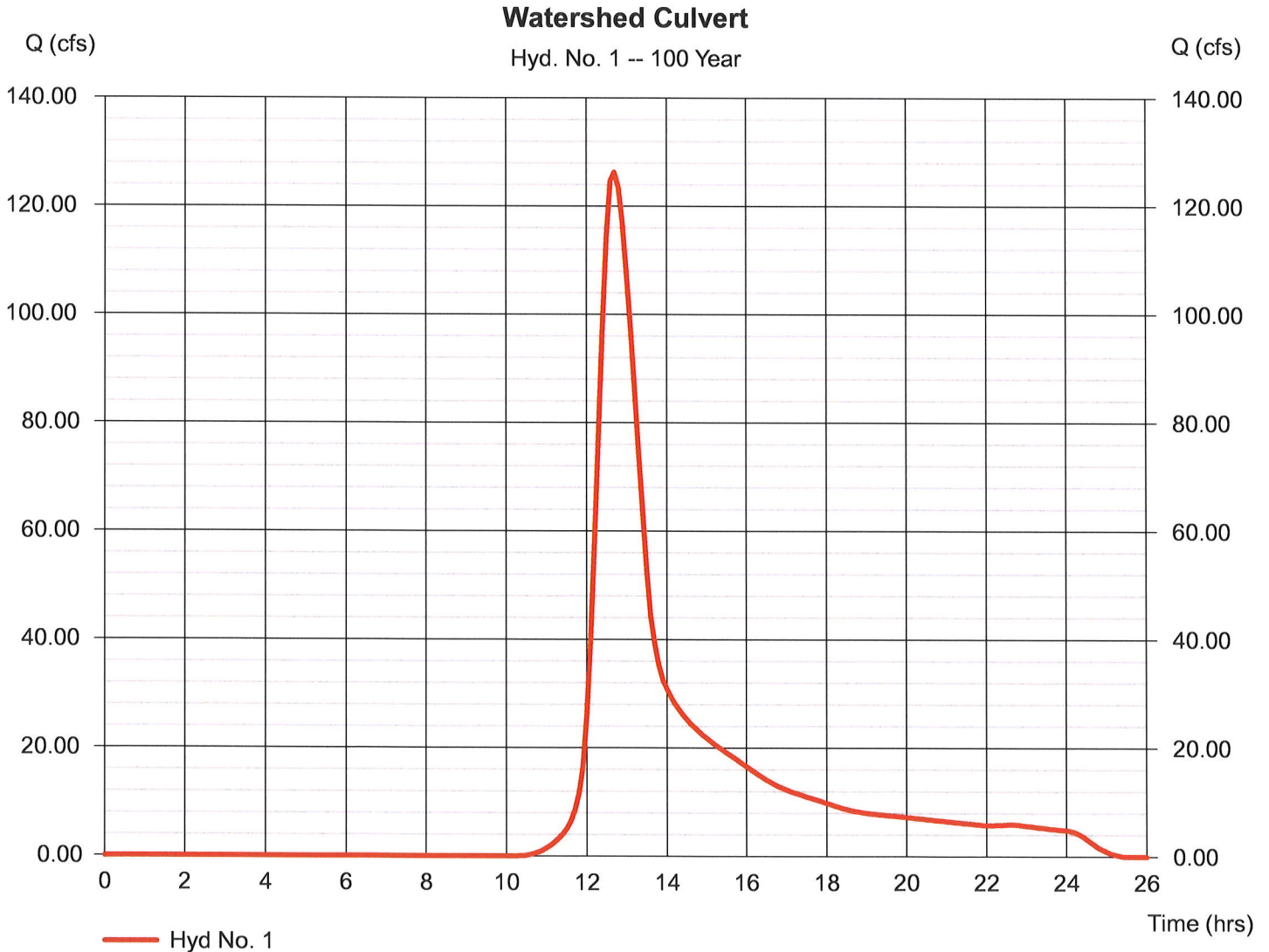

# Hydrograph Report

Hydraflow Hydrographs by Intelisolve v9.1

Monday, Feb 27, 2017

## Hyd. No. 2

### Culvert

Hydrograph type = Reservoir  
Storm frequency = 100 yrs  
Time interval = 6 min  
Inflow hyd. No. = 1 - Watershed Culvert  
Reservoir name = Culvert

Peak discharge = 126.63 cfs  
Time to peak = 12.70 hrs  
Hyd. volume = 991,578 cuft  
Max. Elevation = 232.83 ft  
Max. Storage = 12,114 cuft

Storage Indication method used.

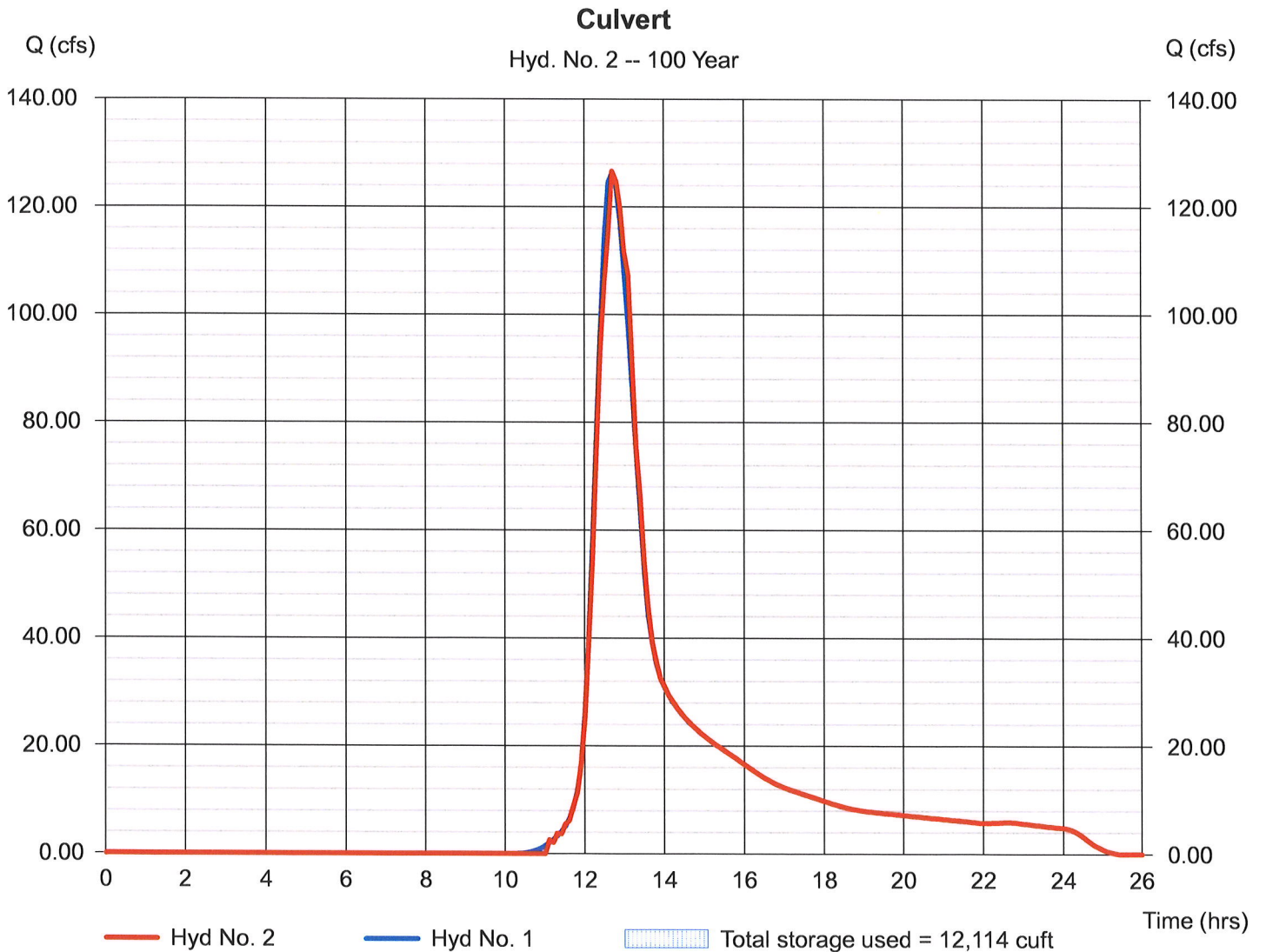

# Pond Report

## Pond No. 1 - Culvert

### Pond Data

Contours - User-defined contour areas. Conic method used for volume calculation. Beginning Elevation = 228.50 ft

### Stage / Storage Table

Stage (ft)	Elevation (ft)	Contour area (sqft)	Incr. Storage (cuft)	Total storage (cuft)
0.00	228.50	00	0	0
1.50	230.00	828	414	414
2.50	231.00	2,951	1,781	2,194
3.50	232.00	5,572	4,192	6,387
4.50	233.00	8,442	6,957	13,344
5.50	234.00	33,270	19,488	32,832
6.50	235.00	68,366	49,771	82,603

### Culvert / Orifice Structures

	[A]	[B]	[C]	[PrfRsr]
Rise (in)	= 48.00	0.00	0.00	0.00
Span (in)	= 60.00	0.00	0.00	0.00
No. Barrels	= 1	1	0	0
Invert El. (ft)	= 228.50	0.00	0.00	0.00
Length (ft)	= 70.00	0.00	0.00	0.00
Slope (%)	= 1.50	0.00	0.00	n/a
N-Value	= .020	.012	.013	n/a
Orifice Coeff.	= 0.60	0.60	0.60	0.60
Multi-Stage	= n/a	No	No	No

### Weir Structures

	[A]	[B]	[C]	[D]
Crest Len (ft)	= 0.00	0.00	0.00	0.00
Crest El. (ft)	= 0.00	0.00	0.00	0.00
Weir Coeff.	= 2.60	3.33	3.33	3.33
Weir Type	= Broad	---	---	---
Multi-Stage	= No	No	No	No
Exfil.(in/hr)	= 0.000 (by Contour)			
TW Elev. (ft)	= 230.62			

Note: Culvert/Orifice outflows are analyzed under inlet (ic) and outlet (oc) control. Weir risers checked for orifice conditions (ic) and submergence (s).

### Stage / Storage / Discharge Table

Stage ft	Storage cuft	Elevation ft	Clv A cfs	Clv B cfs	Clv C cfs	PrfRsr cfs	Wr A cfs	Wr B cfs	Wr C cfs	Wr D cfs	Exfil cfs	User cfs	Total cfs
0.00	0	228.50	0.00	---	---	---	---	---	---	---	---	---	0.00
0.15	41	228.65	0.00	---	---	---	---	---	---	---	---	---	0.00
0.30	83	228.80	0.00	---	---	---	---	---	---	---	---	---	0.00
0.45	124	228.95	0.00	---	---	---	---	---	---	---	---	---	0.00
0.60	166	229.10	0.00	---	---	---	---	---	---	---	---	---	0.00
0.75	207	229.25	0.00	---	---	---	---	---	---	---	---	---	0.00
0.90	248	229.40	0.00	---	---	---	---	---	---	---	---	---	0.00
1.05	290	229.55	0.00	---	---	---	---	---	---	---	---	---	0.00
1.20	331	229.70	0.00	---	---	---	---	---	---	---	---	---	0.00
1.35	373	229.85	0.00	---	---	---	---	---	---	---	---	---	0.00
1.50	414	230.00	0.00	---	---	---	---	---	---	---	---	---	0.00
1.60	592	230.10	0.00	---	---	---	---	---	---	---	---	---	0.00
1.70	770	230.20	0.00	---	---	---	---	---	---	---	---	---	0.00
1.80	948	230.30	0.00	---	---	---	---	---	---	---	---	---	0.00
1.90	1,126	230.40	0.00	---	---	---	---	---	---	---	---	---	0.00
2.00	1,304	230.50	0.00	---	---	---	---	---	---	---	---	---	0.00
2.10	1,482	230.60	0.00	---	---	---	---	---	---	---	---	---	0.00
2.20	1,660	230.70	16.99 oc	---	---	---	---	---	---	---	---	---	16.99
2.30	1,838	230.80	26.77 oc	---	---	---	---	---	---	---	---	---	26.77
2.40	2,016	230.90	35.00 oc	---	---	---	---	---	---	---	---	---	35.00
2.50	2,194	231.00	42.64 oc	---	---	---	---	---	---	---	---	---	42.64
2.60	2,614	231.10	50.02 oc	---	---	---	---	---	---	---	---	---	50.02
2.70	3,033	231.20	57.29 oc	---	---	---	---	---	---	---	---	---	57.29
2.80	3,452	231.30	64.54 oc	---	---	---	---	---	---	---	---	---	64.54
2.90	3,871	231.40	71.80 oc	---	---	---	---	---	---	---	---	---	71.80
3.00	4,291	231.50	79.11 oc	---	---	---	---	---	---	---	---	---	79.11
3.10	4,710	231.60	86.49 oc	---	---	---	---	---	---	---	---	---	86.49
3.20	5,129	231.70	92.63 oc	---	---	---	---	---	---	---	---	---	92.63
3.30	5,548	231.80	95.75 oc	---	---	---	---	---	---	---	---	---	95.75
3.40	5,968	231.90	98.86 oc	---	---	---	---	---	---	---	---	---	98.86
3.50	6,387	232.00	101.97 oc	---	---	---	---	---	---	---	---	---	101.97
3.60	7,082	232.10	105.08 oc	---	---	---	---	---	---	---	---	---	105.08
3.70	7,778	232.20	108.20 oc	---	---	---	---	---	---	---	---	---	108.20
3.80	8,474	232.30	111.31 oc	---	---	---	---	---	---	---	---	---	111.31
3.90	9,169	232.40	114.42 oc	---	---	---	---	---	---	---	---	---	114.42

Continues on next page...

Culvert

**Stage / Storage / Discharge Table**

Stage ft	Storage cuft	Elevation ft	Civ A cfs	Civ B cfs	Civ C cfs	PrfRsr cfs	Wr A cfs	Wr B cfs	Wr C cfs	Wr D cfs	Exfil cfs	User cfs	Total cfs
4.00	9,865	232.50	110.73 oc	---	---	---	---	---	---	---	---	---	110.73
4.10	10,561	232.60	115.89 oc	---	---	---	---	---	---	---	---	---	115.89
4.20	11,257	232.70	120.82 oc	---	---	---	---	---	---	---	---	---	120.82
4.30	11,952	232.80	125.56 oc	---	---	---	---	---	---	---	---	---	125.56
4.40	12,648	232.90	130.13 oc	---	---	---	---	---	---	---	---	---	130.13
4.50	13,344	233.00	134.54 oc	---	---	---	---	---	---	---	---	---	134.54
4.60	15,292	233.10	138.81 oc	---	---	---	---	---	---	---	---	---	138.81
4.70	17,241	233.20	142.96 oc	---	---	---	---	---	---	---	---	---	142.96
4.80	19,190	233.30	146.99 oc	---	---	---	---	---	---	---	---	---	146.99
4.90	21,139	233.40	150.91 oc	---	---	---	---	---	---	---	---	---	150.91
5.00	23,088	233.50	154.73 oc	---	---	---	---	---	---	---	---	---	154.73
5.10	25,037	233.60	158.46 oc	---	---	---	---	---	---	---	---	---	158.46
5.20	26,985	233.70	162.10 oc	---	---	---	---	---	---	---	---	---	162.10
5.30	28,934	233.80	165.66 oc	---	---	---	---	---	---	---	---	---	165.66
5.40	30,883	233.90	169.15 oc	---	---	---	---	---	---	---	---	---	169.15
5.50	32,832	234.00	172.57 oc	---	---	---	---	---	---	---	---	---	172.57
5.60	37,809	234.10	175.92 oc	---	---	---	---	---	---	---	---	---	175.92
5.70	42,786	234.20	179.21 oc	---	---	---	---	---	---	---	---	---	179.21
5.80	47,763	234.30	182.44 oc	---	---	---	---	---	---	---	---	---	182.44
5.90	52,740	234.40	185.61 oc	---	---	---	---	---	---	---	---	---	185.61
6.00	57,717	234.50	188.73 oc	---	---	---	---	---	---	---	---	---	188.73
6.10	62,695	234.60	191.80 oc	---	---	---	---	---	---	---	---	---	191.80
6.20	67,672	234.70	194.52 ic	---	---	---	---	---	---	---	---	---	194.52
6.30	72,649	234.80	196.89 ic	---	---	---	---	---	---	---	---	---	196.89
6.40	77,626	234.90	199.23 ic	---	---	---	---	---	---	---	---	---	199.23
6.50	82,603	235.00	201.54 ic	---	---	---	---	---	---	---	---	---	201.54

...End

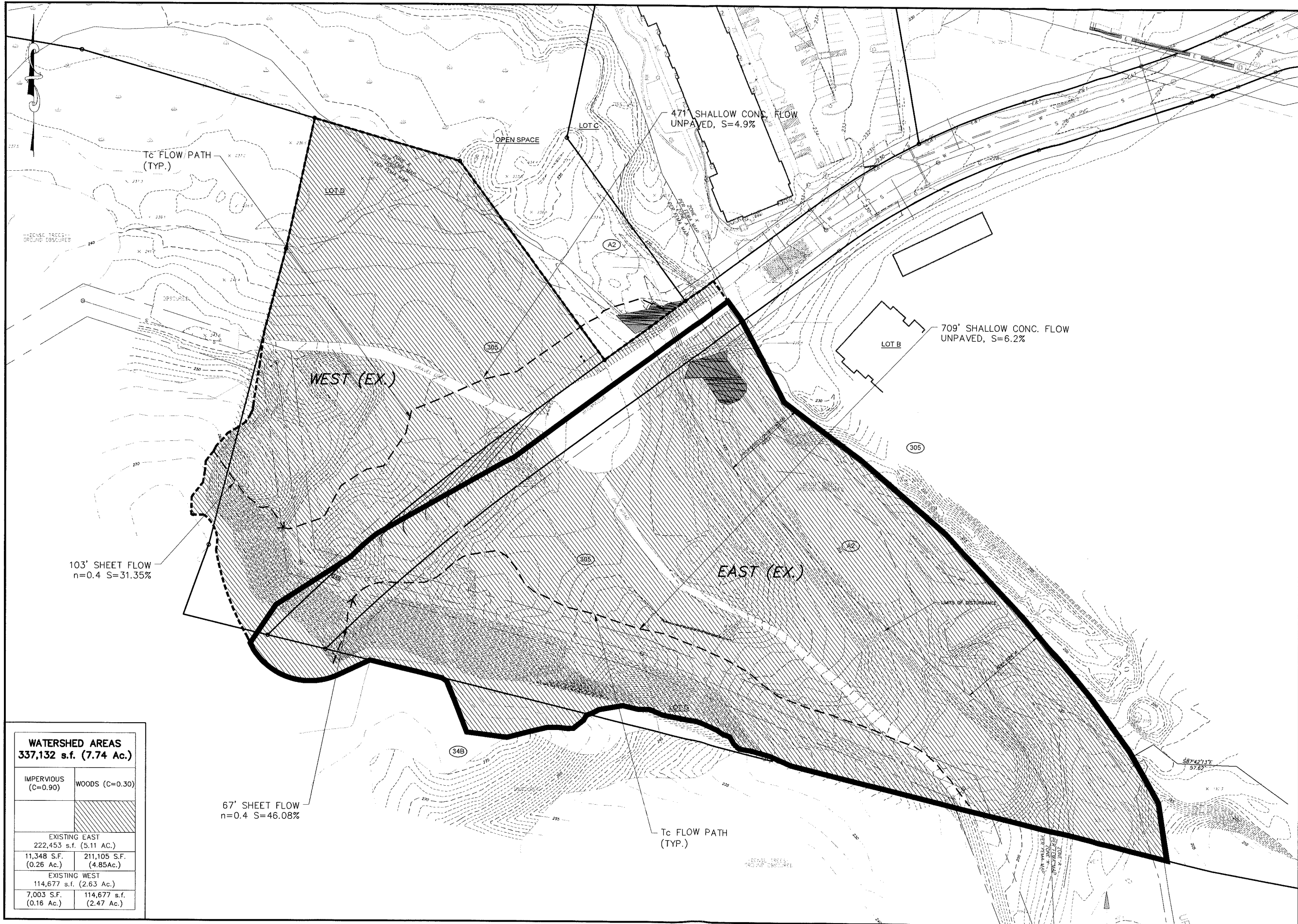

WATERSHED AREAS 337,132 s.f. (7.74 Ac.)	
IMPERVIOUS (C=0.90)	WOODS (C=0.30)
EXISTING EAST 222,453 s.f. (5.11 Ac.)	
11,348 S.F. (0.26 Ac.)	211,105 S.F. (4.85Ac.)
EXISTING WEST 114,677 s.f. (2.63 Ac.)	
7,003 S.F. (0.16 Ac.)	114,677 s.f. (2.47 Ac.)

No.	Date	Description

DRAINAGE ANALYSIS PLAN  
 EXISTING CONDITIONS  
 PREPARED FOR  
**CROWN PROPERTY HOLDINGS, LLC**  
 CASTERBRIDGE CROSSING  
 SIMSBURY, CONNECTICUT  
 Date: 12-03-2021 Drawn by: DRT Job no: 04174  
 Scale: 1" = 40' Checked by: DSZ Sheet no. 1 OF 1

**DA-1**

**Crown Simsbury**  
**F. A. Hesketh & Associates, Inc.**  
 3 Creamery Brook, East Granby, CT 06026  
 Phone (860) 653-9000 Fax (860) 844-8600  
 www.fahsketh.com mail@fahsketh.com  
 Civil & Traffic Engineers · Surveyors · Planners · Landscape Architects



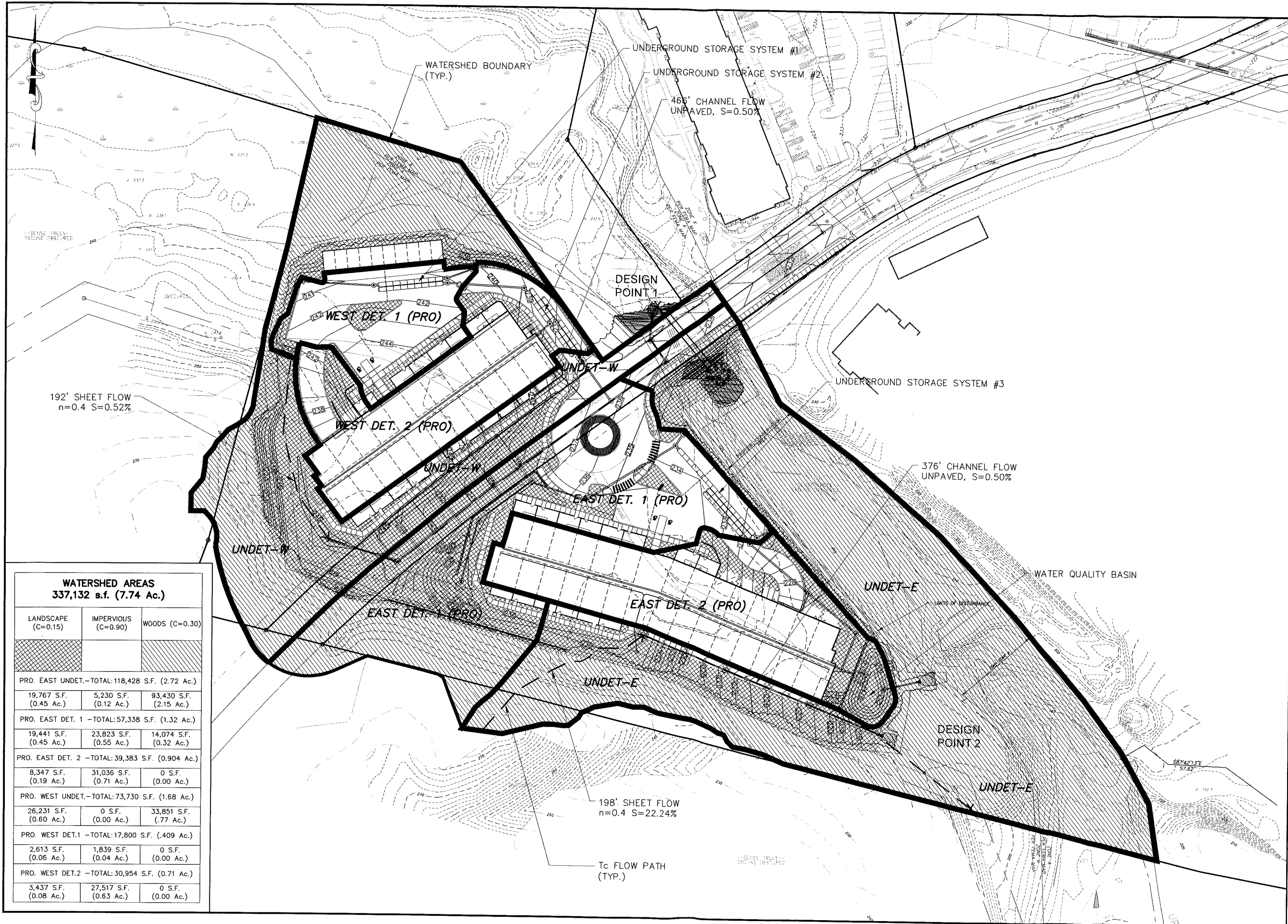

192' SHEET FLOW  
n=0.4 S=0.52%

198' SHEET FLOW  
n=0.4 S=22.24%

WATERSHED AREAS 337,132 s.f. (7.74 Ac.)		
LANDSCAPE (C=0.15)	IMPERVIOUS (C=0.90)	WOODS (C=0.30)
PRO. EAST UNDET.-TOTAL: 118,428 S.F. (2.72 Ac.)		
19,767 S.F. (0.45 Ac.)	5,230 S.F. (0.12 Ac.)	93,430 S.F. (2.15 Ac.)
PRO. EAST DET. 1 -TOTAL: 57,338 S.F. (1.32 Ac.)		
19,441 S.F. (0.45 Ac.)	23,823 S.F. (0.55 Ac.)	14,074 S.F. (0.32 Ac.)
PRO. EAST DET. 2 -TOTAL: 39,383 S.F. (0.904 Ac.)		
8,347 S.F. (0.19 Ac.)	31,036 S.F. (0.71 Ac.)	0 S.F. (0.00 Ac.)
PRO. WEST UNDET.-TOTAL: 73,730 S.F. (1.68 Ac.)		
26,231 S.F. (0.60 Ac.)	0 S.F. (0.00 Ac.)	33,851 S.F. (.77 Ac.)
PRO. WEST DET.1 -TOTAL: 17,800 S.F. (.409 Ac.)		
2,613 S.F. (0.06 Ac.)	1,839 S.F. (0.04 Ac.)	0 S.F. (0.00 Ac.)
PRO. WEST DET.2 -TOTAL: 30,954 S.F. (0.71 Ac.)		
3,437 S.F. (0.08 Ac.)	27,517 S.F. (0.63 Ac.)	0 S.F. (0.00 Ac.)

# Crown Simsbury

F. A. Hesketh & Associates, Inc.  
3 Creamery Brook, East Granby, CT 06026  
Phone (860) 653-8000 Fax (860) 844-8600  
www.fah.com · Landscapes Architects  
Civil & Traffic Engineers · Surveyors · Planners

No.	Date	Description

DRAINAGE ANALYSIS PLAN  
PROPOSED CONDITIONS  
PREPARED FOR  
**CROWN PROPERTY HOLDINGS, LLC**  
CASTERBRIDGE CROSSING  
SIMSBURY, CONNECTICUT

Date: 12-03-2021 Drawn by: DRT Job no.: 04774  
Scale: 1" = 40' Checked by: DSZ Sheet no.: 1 OF 1

DA-2

0:2023/04/14:30 - Cont. 6 and 7 (castbr) (Submitted 06/21/21) - Conservation VAP/DA-1/2021-11-29.dwg, DC-2, Dec. 02, 2021 - 3:48:18 PM