

Dunkin' | 142 Hopmeadow Street, Simsbury, CT 06089 | NextGen Branding Package | December 13, 2021

---



## Exclusive Brand Identity Warranty Program

**Poyant is the only Approved DBI Brands Vendor to provide an Exclusive 3 Year Comprehensive Labor and Material Warranty on all aspects of the Dunkin' Donuts and Baskin Robbins Brand Package.**

Our Warranty to you is supported by the largest installation and service fleet in New England as well as a reliable, qualified national network.

Poyant's Exclusive 3 Year Warranty Program for DBI includes:

Comprehensive Warranty including all labor and material and covers the following:

- Construction and framework of your displays
- Paint finish against peeling and noticeable fading of acrylic polyurethane finishes
- Polycarbonate G.E. Lexan faces are guaranteed against breakage
- All internal lighting components, electrical system, LED's and power supplies
- Steel support structures

Factory Trained Service Technicians anywhere in New England

\*For shipped sign product warranty covers sign product only\*

Customer \_\_\_\_\_

Location \_\_\_\_\_

Install Date \_\_\_\_\_ Poyant \_\_\_\_\_ Date \_\_\_\_\_

Excludes "Acts of God", Hurricanes, Unusual Flooding, and Fire.



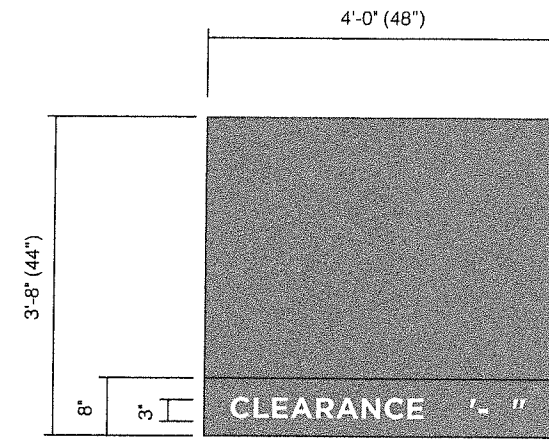

**A** Awning - Side View - Car Approach Side  
Scale: 1/2"=1'-0"

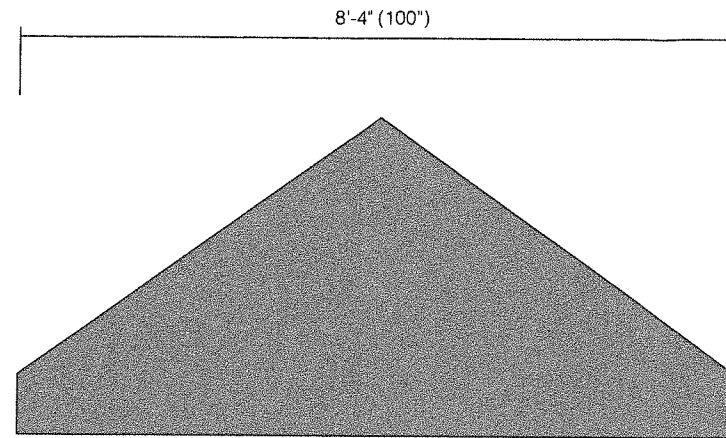

**B** Awning - Front View  
Scale: 1/2"=1'-0"

**Specifications**

Qty: 1

**Illuminated Awning**

- Aluminum tube awning structure; stainless steel screw at ends of beading
- New LED Lighting
- Solid orange awning material
- Clearance to be white reflective vinyl
- Egg crate bottom
- Silicone at top once installed to prevent water leakage
- Center over drive thru window

\*120V

VIF:

- Confirm Fascia Measurements (H,W,D)

**Colors & Materials**

**Awning Material**

-  Solid Orange Ferrari Fabric

**Vinyl**

-  White Reflective (Clearance)  
3M 680-10

**Poyant**  
Building Your Brand

125 Samuel Barnet Boulevard  
New Bedford, MA 02745  
800.544.0961 | poyantsigns.com

**DUNKIN'**

142 Hopmeadow Street  
Simsbury, CT 06089

Project: 20380  
Dunkin'

Sales: Bill Gavigan Jr.  
Date: 11.24.21  
Designer: RMA

**Note:**  
This is an original unpublished drawing created by Poyant Signs, Inc. It is submitted for your personal use in connection with a project being planned for you by Poyant Signs, Inc. It is not to be shown to anyone outside your organization, nor is it to be reproduced, copied or exhibited in any fashion until transferred.

**Revisions:**  
12 13 21 RMA (R1) Added to Package



This sign is intended to be installed in accordance with the requirements of Article 600 of the National Electrical Code and / or other applicable local codes. This includes proper grounding and bonding of the sign.



All Signage Shown is Covered by Poyant's Exclusive DD Franchisee 3 Year Brand Identity Warranty Program

Approved By:

Date:

Internally Illuminated Awning

Option A

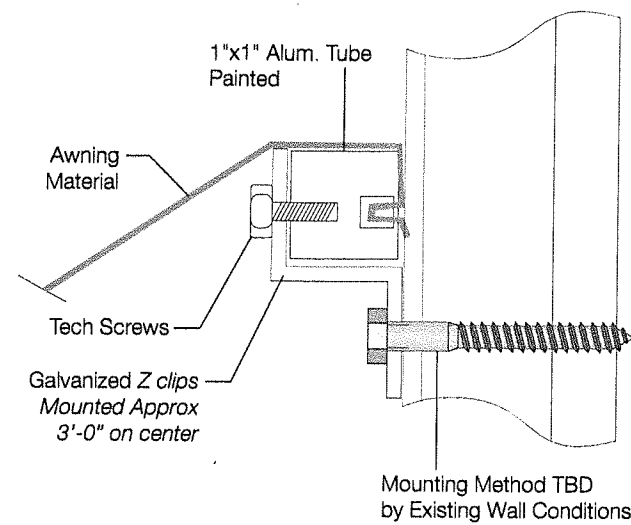

**C** Awning Detail  
Not to Scale



**D** Photo Comp - Existing  
Not to Scale



**E** Photo Comp - Proposed (Day)  
Not to Scale